

**PowerLite[®] EB-L520U/EB-L530U/EB-
L630U/EB-L630SU/EB-L635SU/EB-
L730U/EB-L735U User's Guide**

Contents

PowerLite® EB-L520U/EB-L530U/EB-L630U/EB-L630SU/EB-L635SU/EB-L730U/EB-L735U User's Guide	11
Introduction to Your Projector	12
Projector Features.....	12
Product Box Contents.....	13
Additional Components	14
Additional Projector Software and Manuals	15
Optional Equipment and Replacement Parts (U.S. and Canada).....	16
Optional Equipment and Replacement Parts (Latin America).....	17
Warranty and Registration Information (U.S. and Canada).....	18
Warranty and Registration Information (Latin America).....	18
Notations Used in the Documentation	18
Where to Go for Additional Information	18
Projector Part Locations	19
Projector Parts - Front/Top	20
Projector Parts - Rear	22
Projector Parts - Interface Ports	23
Projector Parts - Base.....	24
Projector Parts - Control Panel	25
Projector Parts - Remote Control.....	26
Setting Up the Projector	28
Projector Placement.....	28
Projector Setup and Installation Options	28
Projection Distance.....	32
Projector Connections.....	47
Connecting to Computer Sources.....	47
Connecting to a Computer for VGA Video and Audio.....	47
Connecting to a Computer for HDMI Video and Audio.....	49
Connecting to Video Sources	50
Connecting to an HDMI Video Source	50

Connecting to a USB Device	51
Connecting to a Streaming Media Player	52
Connecting to a Document Camera	53
Connecting to an HDBaseT Transmitter	53
Connecting to an External Computer Monitor	55
Connecting to External Speakers	56
Connecting Multiple Projectors of the Same Model	57
Multiple Projector Connection Menu Settings	57
Attaching and Removing the Cable Cover.....	58
Installing Batteries in the Remote Control	60
Using the Projector on a Network	63
Wired Network Projection.....	63
Connecting to a Wired Network	64
Selecting Wired Network Settings	64
Wireless Network Projection	67
Installing the Wireless LAN Module	68
Using Quick Wireless Connection (Windows).....	69
Selecting Wireless Network Settings Manually.....	71
Wireless LAN Menu Settings	75
Selecting Wireless Network Settings in Windows	78
Selecting Wireless Network Settings on Mac	78
Setting Up Wireless Network Security	78
Using a QR Code to Connect a Mobile Device	80
Wireless Network Projection from a Mobile Device or Windows Computer (Screen Mirroring)	81
Screen Mirroring Restrictions.....	82
Selecting Screen Mirroring Settings.....	82
Connecting for Screen Mirroring with Miracast	85
Connecting for Screen Mirroring with a Windows 8.x/Windows 10 Computer.....	86
Screen Sharing	87
Sharing Your Screen	87
Projecting Screen Sharing Images	89
Setting Up Projector Network E-Mail Alerts	90
Network Projector E-mail Alert Messages	92

Setting Up Monitoring Using SNMP	93
Controlling a Networked Projector Using a Web Browser	93
Web Control Options	95
Controlling a Networked Projector in Content Playback Mode	100
Web Control Options in Content Playback Mode.....	102
Using Crestron Connected	107
Setting Up Crestron Connected.....	108
Controlling a Networked Projector Using Crestron Connected.....	110
Setting Up Web API	111
Secure HTTP	111
Importing a Web Server Certificate Using the Projector Menus.....	112
Registering a Digital Certificate on the Projector	113
Registering Digital Certificates from a Web Browser	113
Digital Certificate Types.....	115
Using Basic Projector Features	117
Turning On the Projector	118
Using the Home Screen.....	119
Turning Off the Projector	121
Selecting the Language for the Projector Menus.....	122
Setting the Date and Time.....	123
Resizing the Image with the Zoom Ring	125
Resizing the Image using Digital Zoom	125
Focusing the Image Using the Focus Ring.....	126
Setting the Screen Type	127
Adjusting the Image Position Using Lens Shift	128
Adjusting the Image Position Using Image Shift.....	130
Adjusting the Image Position Using Screen Position	131
Adjusting the Image Position Horizontally Using Screen Shift.....	131
Displaying a Test Pattern	132
Adjusting the Image Height	133
Image Shape.....	134
Correcting Image Shape with H/V-Keystone	135
Correcting Image Shape with Quick Corner	138

Correcting Image Shape with Arc Correction.....	141
Correcting Image Shape with Point Correction.....	144
Applying Saved Image Shape Settings	146
Selecting an Image Source	146
Remote Control Operation	148
Projection Modes	149
Changing the Projection Mode Using the Remote Control	149
Changing the Projection Mode Using the Menus.....	150
Image Aspect Ratio	151
Changing the Image Aspect Ratio	151
Available Image Aspect Ratios	152
Color Mode.....	153
Changing the Color Mode.....	153
Available Color Modes.....	154
Adjusting the Hue, Saturation, and Brightness	154
Adjusting Gamma.....	156
Turning On Dynamic Contrast	159
Adjusting the Image Resolution.....	159
Adjusting the Projector's Brightness Level	161
Constant Brightness Usage Hours	164
Controlling the Volume with the Volume Buttons.....	165
Projecting a PC Free Presentation	166
PC Free Precautions	167
Supported PC Free File Types	167
Starting a PC Free Slideshow.....	169
Starting a PC Free Movie Presentation	171
PC Free Display Options	173
Projecting in Content Playback Mode.....	174
Switching to Content Playback Mode	174
Projecting a Playlist in Content Playback Mode.....	176
Creating a Playlist Using Epson Web Control.....	177
Adding Effects to the Projected Image.....	178

Adjusting Projector Features	180
Shutting Off the Picture and Sound Temporarily	180
Stopping Video Action Temporarily	181
Zooming Into and Out of Images	182
Projector Security Features	183
Password Security Types	183
Setting a Password	184
Selecting Password Security Types	185
Entering a Password to Use the Projector	186
Saving a User's Logo Image to Display	187
Locking the Projector's Buttons	189
Unlocking the Projector's Buttons	190
Locking the Remote Control Buttons	191
Installing a Security Cable	192
Projecting Multiple Images Simultaneously	192
Input Sources for Split Screen Projection	195
Split Screen Projection Restrictions	195
Using Multiple Projectors	196
Multiple Projector Adjustment Overview	196
Projector Identification System for Multiple Projector Control	197
Setting the Projector ID	197
Setting the Remote Control ID	198
Configuring Tiling Manually	199
Blending the Image Edges	201
Adjusting the Black Level	203
Matching the Image Colors	206
Scaling an Image	208
Saving Settings to Memory and Using Saved Settings	210
Adjusting the Color Tone (Color Uniformity)	212
Running Light Source Calibration	213
Scheduling Projector Events	215
Saving a Scheduled Event	215
Viewing Scheduled Events	217

Editing a Scheduled Event.....	219
Copying Menu Settings Between Projectors	220
Saving Settings to a USB Flash Drive.....	221
Transferring Settings from a USB Flash Drive	222
Saving Settings to a Computer	223
Transferring Settings from a Computer	224
Adjusting the Menu Settings	227
Using the Projector's Menus.....	227
Image Quality Settings - Image Menu	229
Input Signal Settings - Signal I/O Menu.....	234
Installation Settings - Installation Menu	238
Display Settings - Display Menu.....	242
Feature Settings - Operation Menu	244
Administration Settings - Management Menu.....	248
Event ID Code List.....	252
Network Settings - Network Menu	254
Multiple Projector Operation Settings - Multi-Projection Menu	256
Image Quality Memory Settings - Memory Menu	261
Initial Settings and Reset Options - Initial/All Settings Menu	262
Maintaining and Transporting the Projector	264
Projector Maintenance	264
Cleaning the Lens.....	264
Cleaning the Projector Case.....	265
Air Filter and Vent Maintenance	265
Cleaning the Air Filter.....	266
Replacing the Air Filter.....	270
Replacing the Remote Control Batteries	272
Transporting the Projector.....	274
Updating the Firmware	275
Updating Projector Firmware Using a USB Storage Device	275
Updating Projector Firmware Using a Computer and USB Cable.....	276
Solving Problems	278
Projection Problem Tips	278

Projector Light Status	279
Viewing Projector Status Information	283
Projector Status Display Messages	284
Using the Projector Menu Displays	288
Solving Image or Sound Problems	288
Solutions When No Image Appears.....	288
Solutions When "No Signal" Message Appears.....	289
Displaying From a PC Laptop	290
Displaying From a Mac Laptop	291
Solutions When No Image Appears on an External Monitor	291
Solutions When "Not Supported" Message Appears	291
Solutions When Only a Partial Image Appears	292
Solutions When the Image is Not Rectangular	293
Solutions When the Image Contains Noise or Static	293
Solutions When the Image is Fuzzy or Blurry	294
Solutions When the Image Brightness or Colors are Incorrect	295
Solutions When an Afterimage Remains On the Projected Image.....	296
Solutions to Sound Problems	296
Solutions to PC Free Problems	297
Solving Projector or Remote Control Operation Problems	297
Solutions to Projector Power or Shut-Off Problems	298
Solutions to Remote Control Problems.....	299
Solutions to Password Problems	299
Solutions When a Battery Message Appears	300
Solving Network Problems	300
Solutions When Wireless Authentication Fails	301
Solutions When You Cannot Access the Projector Through the Web	301
Solutions When Network Alert E-Mails are Not Received.....	302
Solutions When You Cannot Connect Using Screen Mirroring.....	302
Solutions When the Image Contains Static During Network Projection	303
Solutions When the Image or Sound Contains Static During Screen Mirroring	303
Solutions to Problems Using Content Playback	304
Solutions to HDMI Link Problems.....	304

Where to Get Help (U.S. and Canada)	305
Where to Get Help (Latin America).....	306
Technical Specifications	308
General Projector Specifications	308
Projector Light Source Specifications.....	311
Remote Control Specifications	311
Projector Dimension Specifications.....	311
Projector Electrical Specifications	312
Projector Environmental Specifications.....	313
Projector Safety and Approvals Specifications.....	314
Supported Video Display Formats.....	314
Notices	317
Recycling (U.S. and Canada).....	317
Important Safety Information	317
Laser Safety Information	317
Important Safety Instructions.....	319
Restriction of Use	323
List of Safety Symbols (corresponding to IEC60950-1 A2).....	323
FCC Compliance Statement.....	327
Binding Arbitration and Class Waiver	328
Trademarks	331
Copyright Notice.....	332
A Note Concerning Responsible Use of Copyrighted Materials.....	333
Copyright Attribution	333

PowerLite® EB-L520U/EB-L530U/EB-L630U/EB-L630SU/EB-L635SU/EB-L730U/EB-L735U User's Guide

Welcome to the PowerLite EB-L520U/EB-L530U/EB-L630U/EB-L630SU/EB-L635SU/EB-L730U/EB-L735U *User's Guide*.

For a printable PDF copy of this guide, [click here](#).

Note: Availability of products in this guide varies by country.

Introduction to Your Projector

Refer to these sections to learn more about your projector and this manual.

[Projector Features](#)

[Warranty and Registration Information \(U.S. and Canada\)](#)

[Warranty and Registration Information \(Latin America\)](#)

[Notations Used in the Documentation](#)

[Where to Go for Additional Information](#)

[Projector Part Locations](#)

Projector Features

The PowerLite EB-L520U, EB-L530U, EB-L630U, EB-L630SU, EB-L635SU, EB-L730U, and EB-L735U projectors include these special features:

Bright, high-resolution projection system

- Up to 7000 lumens of brightness (white light output and color light output)

Note: Color brightness (color light output) and white brightness (white light output) will vary depending on usage conditions. Color light output measured in accordance with IDMS 15.4; white light output measured in accordance with ISO 21118.

- Native resolution of 1920 × 1200 pixels (WUXGA)

Flexible connectivity

- Wired and wireless (optional) network support for projection, monitoring, and control via remote network computer
- Projection from iOS or Android devices with free Epson iProjection app
- Two HDMI ports for multiple high-definition input devices
- Miracast screen mirroring for laptops and mobile devices
- Variety of connection methods to computer or video devices including HDMI and HDBaseT
- Ports for connecting an external monitor and external speakers

Easy-to-use setup and operation features

- Epson's quick-connect on-screen QR code feature for easy wireless setup

- Project images side by side from two separate input sources
- Epson's Instant Off and Direct Power On features for quick setup and shut down
- Support for Crestron Connected network monitoring systems
- Network message broadcast system to project timely messages to all networked projectors (Windows only)

Note: The PowerLite EB-L735U is shown in most illustrations in this manual, unless noted otherwise.

[Product Box Contents](#)

[Additional Components](#)

[Additional Projector Software and Manuals](#)

[Optional Equipment and Replacement Parts \(U.S. and Canada\)](#)

[Optional Equipment and Replacement Parts \(Latin America\)](#)

Parent topic: [Introduction to Your Projector](#)

Product Box Contents

Save all the packaging in case you need to ship the projector. Always use the original packaging (or equivalent) when shipping.

Make sure your projector box included all of these parts:

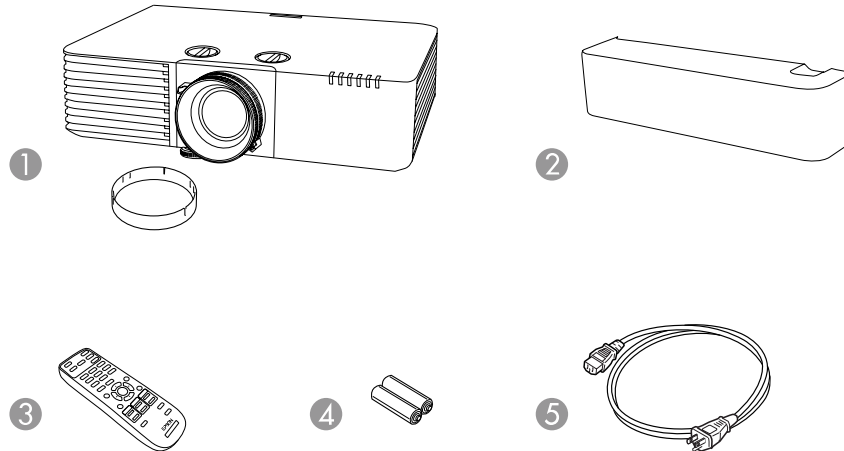

- 1 Projector with lens cap
- 2 Cable cover (PowerLite EB-L530U/EB-L630U/EB-L630SU/EB-L635SU/EB-L730U/EB-L735U)
- 3 Remote control
- 4 Remote control batteries (two AA alkaline)
- 5 Power cord

Parent topic: [Projector Features](#)

Additional Components

Depending on how you plan to use the projector, you may need to obtain additional components.

Note: To connect a Mac that does not include a compatible video output port, you need to obtain an adapter that allows you to connect to an input port on the projector. Contact Apple for compatible adapter options. To connect a smartphone or tablet, you may need to obtain an adapter that allows you to connect to the projector. This allows you to mirror your smartphone or tablet screens, watch movies, and more. Contact your device manufacturer for compatible adapter options.

Unless listed as available from Epson in this table, see your local computer or electronics dealer for purchase information.

Signal or connection type	Additional component necessary
Component video	D-sub, 15-pin, component-to-VGA video cable or adapter Available for purchase from Epson or an authorized Epson reseller.
HDMI	Compatible HDMI cable Available for purchase from Epson or an authorized Epson reseller. Note: Older Mac computers (2009 and earlier) may not support HDMI audio.
Audio from certain ports	Commercially available audio cable compatible with your device
VGA	To connect a computer through its VGA port to the projector's VGA video port, you need a VGA computer cable.
USB	Compatible USB cable

Signal or connection type	Additional component necessary
HDBaseT	Compatible 100Base-TX LAN cable

Parent topic: [Projector Features](#)

Additional Projector Software and Manuals

After connecting and setting up the projector, install the projector software as necessary. You may need to install it from a software CD, if included, or download the software and manuals as necessary.

You can install the projector software programs listed here and view their manuals for instructions on using them.

Note: If you still need help after checking this manual and the sources listed here, you can use the Epson PrivateLine Support service to get help fast (U.S. and Canada only). For details, see "Where to Get Help."

Projector software	Manual	Description
Epson Projector Management (Windows only)	<i>Epson Projector Management Operation Guide</i>	Lets you monitor and control your projector through the network. You can download the latest software and documentation from the Epson web site.
Epson iProjection (Windows/Mac)	<i>Epson iProjection Operation Guide (Windows/Mac)</i>	Lets you project the computer screens of users over a network. You can download the latest software and documentation from the Epson web site.
Epson iProjection app	Instructions are included with the app	Lets you project from an iOS device, Android device, or Chromebook if your projector is connected to a network that includes a wireless access point. Visit epson.com/support (U.S.), epson.ca/support (Canada), or latin.epson.com/support (Caribbean) for more information.

Projector software	Manual	Description
Epson Projector Professional Tool (Windows/Mac)	<i>Epson Projector Professional Tool Operation Guide</i>	Lets you manage multiple Epson projectors simultaneously You can download the latest software and documentation from the Epson web site.
—	<i>Open Source Software License</i>	You can download this document from the Epson web site.
Epson Projector Content Manager	<i>Epson Projector Content Manager Operation Guide</i>	You can download the latest software and documentation from the Epson web site. Go to epson.com/support (U.S.), epson.ca/support (Canada), or latin.epson.com/support (Caribbean) and select your projector.
Epson Creative Projection (iOS only)	Instructions are included with the app (instructions included with the app available only in English)	Lets you create custom content using built-in templates and stamps, and wirelessly transfer it to the projector if it is connected to a network that includes a wireless access point. You can download the latest software and documentation from the Apple App Store.

Note: Epson iProjection is not recommended for use with streaming video.

Parent topic: [Projector Features](#)

Related references

[Where to Get Help \(U.S. and Canada\)](#)

[Where to Get Help \(Latin America\)](#)

Optional Equipment and Replacement Parts (U.S. and Canada)

You can purchase screens, other optional accessories, and replacement parts from an Epson authorized reseller. To find the nearest reseller, call 800-GO-EPSON (800-463-7766) in the U.S. or 800-807-7766 in Canada. Or you can purchase online at epsonstore.com (U.S. sales) or epsonstore.ca (Canadian sales).

Epson offers the following optional accessories and replacement parts for your projector:

Option or part	Part number
Replacement air filter (ELPAF56)	V13H134A56

Option or part	Part number
Wireless LAN module (ELPAP11)	V12H731P02
HDBaseT transmitter (ELPHD01)	V12H547020
Safety wire (ELPWR01)	V12H003W01
External speakers (ELPSP02)	V12H467020
Epson DC-07 document camera (ELPDC07)	V12H759020
Epson DC-13 document camera (ELPDC13)	V12H757020
Epson DC-21 document camera (ELPDC21)	V12H758020
Universal mount (ELPMBPJG)	V12H808001
Custom Micro-Adjustable Projector Mount (ELPMBPRH)	V12H809001

In addition to the accessories listed above, 1-year and 2-year extended service plans are available.

Parent topic: [Projector Features](#)

Related references

[Where to Get Help \(U.S. and Canada\)](#)

Optional Equipment and Replacement Parts (Latin America)

You can purchase optional accessories and replacement parts from an Epson authorized reseller. To find the nearest reseller, go to latin.epson.com. Or you can contact your nearest sales office as described in "Where to Get Help".

Note: Availability of accessories varies by country.

Epson offers the following optional accessories and replacement parts for your projector:

Option or part	Part number
Replacement air filter (ELPAF56)	V13H134A56
Wireless LAN module (ELPAP11)	V12H731P02
HDBaseT transmitter (ELPHD01)	V12H547020
Safety wire (ELPWR01)	V12H003W01

Parent topic: [Projector Features](#)

Related references

[Where to Get Help \(Latin America\)](#)

Warranty and Registration Information (U.S. and Canada)

Your projector comes with a basic warranty that lets you project with confidence. For details, see the warranty brochure that came with your projector.

Register your product online at this site: epson.com/webreg

Registering also lets you receive special updates on new accessories, products, and services.

Parent topic: [Introduction to Your Projector](#)

Warranty and Registration Information (Latin America)

Your projector comes with a basic warranty that lets you project with confidence. For details, see the warranty that came with your projector.

Register your product online at latin.epson.com/support, search for your product, and select **Register**.

Registering also lets you receive special updates on new accessories, products, and services.

Parent topic: [Introduction to Your Projector](#)

Notations Used in the Documentation

Follow the guidelines in these notations as you read your documentation:

- **Warnings** must be followed carefully to avoid bodily injury.
- **Cautions** must be observed to avoid damage to your equipment.
- **Notes** contain important information about your projector.
- **Tips** contain additional projection information.

Parent topic: [Introduction to Your Projector](#)

Where to Go for Additional Information

Need quick help on using your projector? Here's where to look for help:

- epson.com/support (U.S.), epson.ca/support (Canada), or latin.epson.com/support (Caribbean)

View FAQs (frequently asked questions) and e-mail your questions to Epson technical support 24 hours a day.

- If you still need help after checking this manual and any other sources listed here, you can use the Epson PrivateLine Support service to get help fast. For details, see "Where to Get Help."

Parent topic: [Introduction to Your Projector](#)

Related references

[Where to Get Help \(U.S. and Canada\)](#)

[Where to Get Help \(Latin America\)](#)

Projector Part Locations

Check the projector part illustrations to learn about the parts on your projector.

Note: The PowerLite EB-L735U is shown in most illustrations in this manual, unless noted otherwise.

[Projector Parts - Front/Top](#)

[Projector Parts - Rear](#)

[Projector Parts - Interface Ports](#)

[Projector Parts - Base](#)

[Projector Parts - Control Panel](#)

[Projector Parts - Remote Control](#)

Parent topic: [Introduction to Your Projector](#)

Projector Parts - Front/Top

PowerLite EB-L530U/EB-L630U/EB-L630SU/EB-L635SU/EB-L730U/EB-L735U

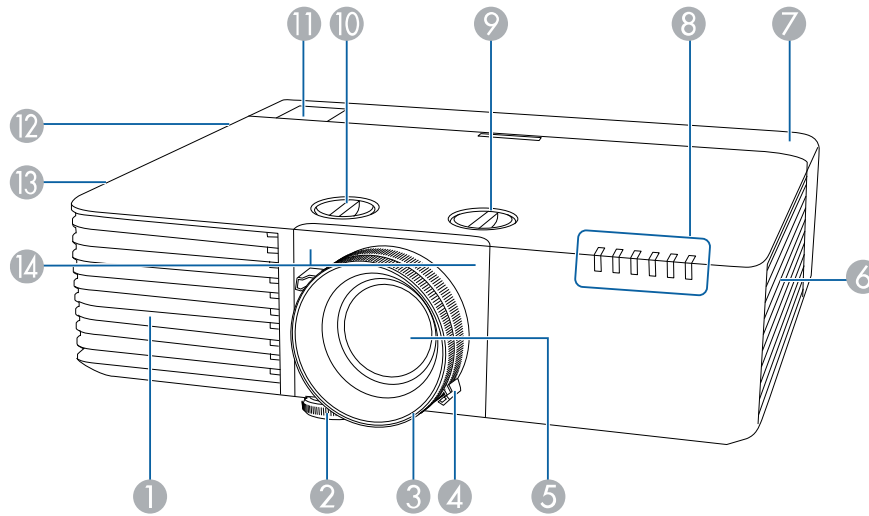

- 1 Air intake vent
- 2 Front adjustable foot
- 3 Focus ring
- 4 Zoom ring (PowerLite EB-L530U/EB-L630U/EB-L730U/EB-L735U only)
- 5 Projection lens
- 6 Air intake vent (air filter)
- 7 Cable cover
- 8 Status lights
- 9 Vertical lens shift dial
- 10 Horizontal lens shift dial
- 11 Remote receiver
- 12 Speaker

- 13 Air exhaust vent
- 14 Remote receiver

PowerLite EB-L520U

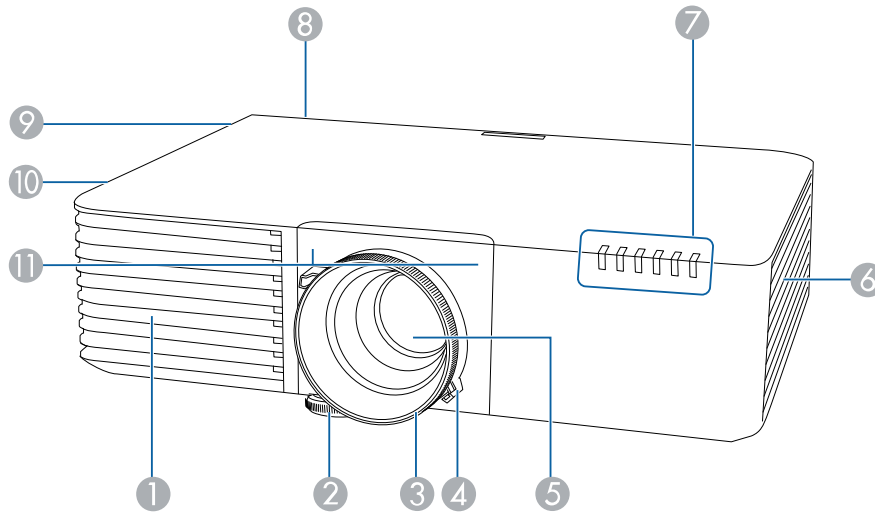

- 1 Air intake vent
- 2 Front adjustable foot
- 3 Focus ring
- 4 Zoom ring
- 5 Projection lens
- 6 Air intake vent (air filter)
- 7 Status lights
- 8 Remote receiver
- 9 Speaker
- 10 Air exhaust vent
- 11 Remote receiver

Parent topic: [Projector Part Locations](#)

Related references

[Projector Light Status](#)

Projector Parts - Rear

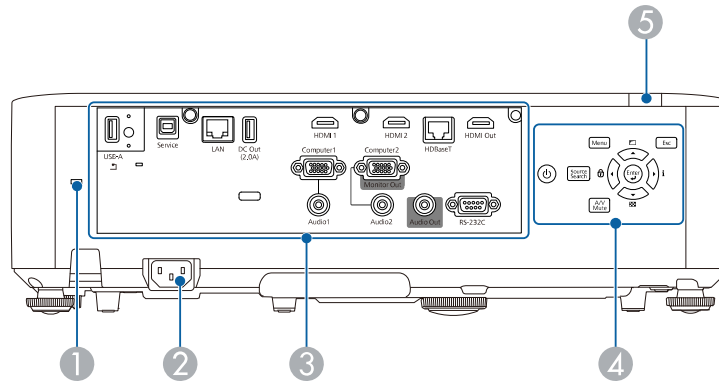

- 1 Kensington security slot
- 2 AC inlet
- 3 Interface ports
- 4 Control panel
- 5 Remote receiver

Parent topic: [Projector Part Locations](#)

Projector Parts - Interface Ports

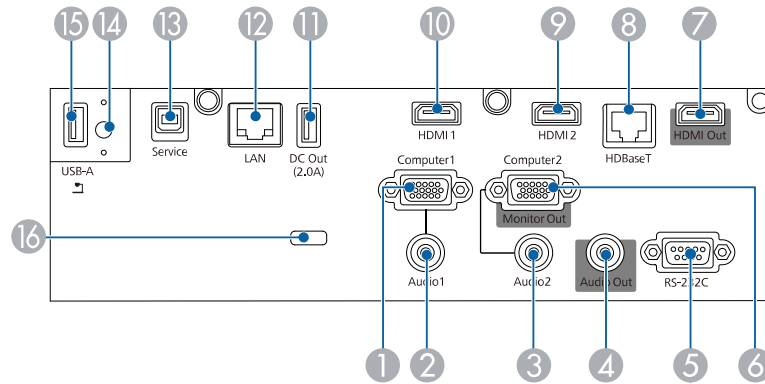

- 1 **Computer1** port
- 2 **Audio1** port
- 3 **Audio2** port
- 4 **Audio Out** port
- 5 **RS-232C** port
- 6 **Computer2/Monitor Out** port
- 7 **HDMI Out** port*
- 8 **HDBaseT** port
- 9 **HDMI2** port
- 10 **HDMI1** port
- 11 **DC Out (2.0A)** port*
- 12 Network **LAN** port
- 13 **Service** port
- 14 Wireless LAN module cover screw
- 15 **USB-A** port
- 16 Cable holder

* Not available on the PowerLite EB-L520U

Parent topic: [Projector Part Locations](#)

Projector Parts - Base

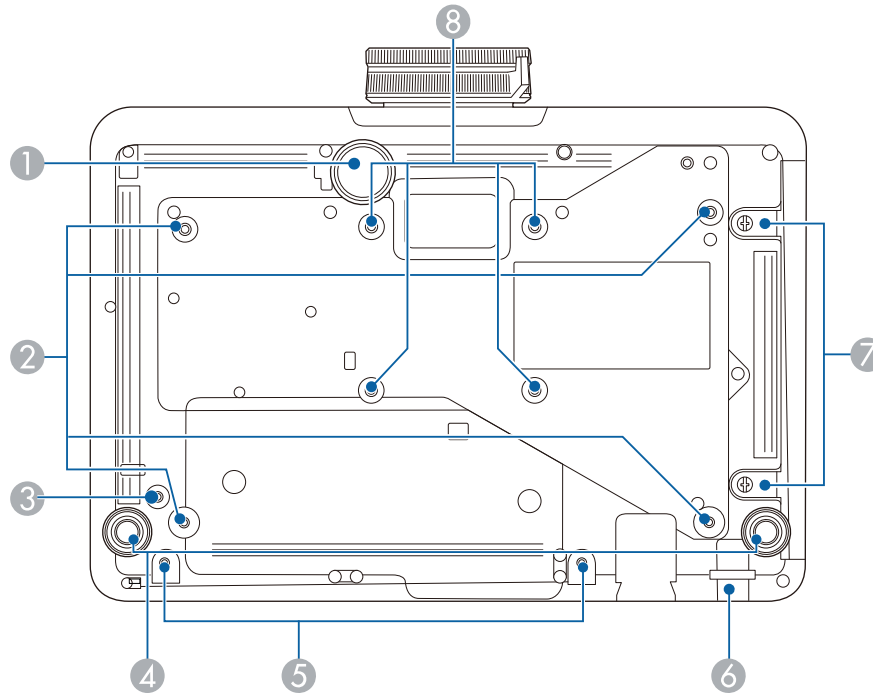

- 1 Front adjustable foot
- 2 Ceiling mount attachment points (4)
- 3 Safety wire carabiner attachment point
- 4 Rear feet
- 5 Cable cover screw holes (2) (Not available for the PowerLite EB-L520U)
- 6 Security cable attachment point

Note: Do not attach the optional safety wire to this point.

- 7 Air filter cover screws (2)
- 8 VESA-compliant mount attachment points (4)

Parent topic: [Projector Part Locations](#)

Projector Parts - Control Panel

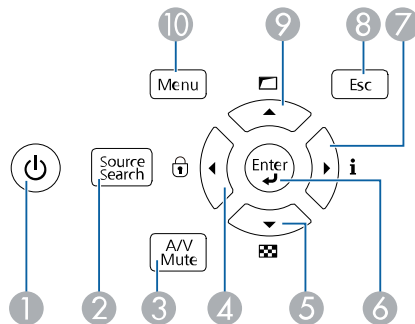

- 1 Power button (turns on the projector)
- 2 **Source Search** button (searches for connected sources)
- 3 **A/V Mute** button (turns the video and audio on or off)
- 4 Left arrow button and displays the Control Panel Lock screen
- 5 Down arrow button and displays a test pattern
- 6 **Enter** button (selects options)
- 7 Right arrow button and displays the Info menu
- 8 **Esc** button (cancels/exits functions)
- 9 Up arrow button and displays screen adjustment options
- 10 **Menu** button (accesses projector menu system)

Parent topic: [Projector Part Locations](#)

Projector Parts - Remote Control

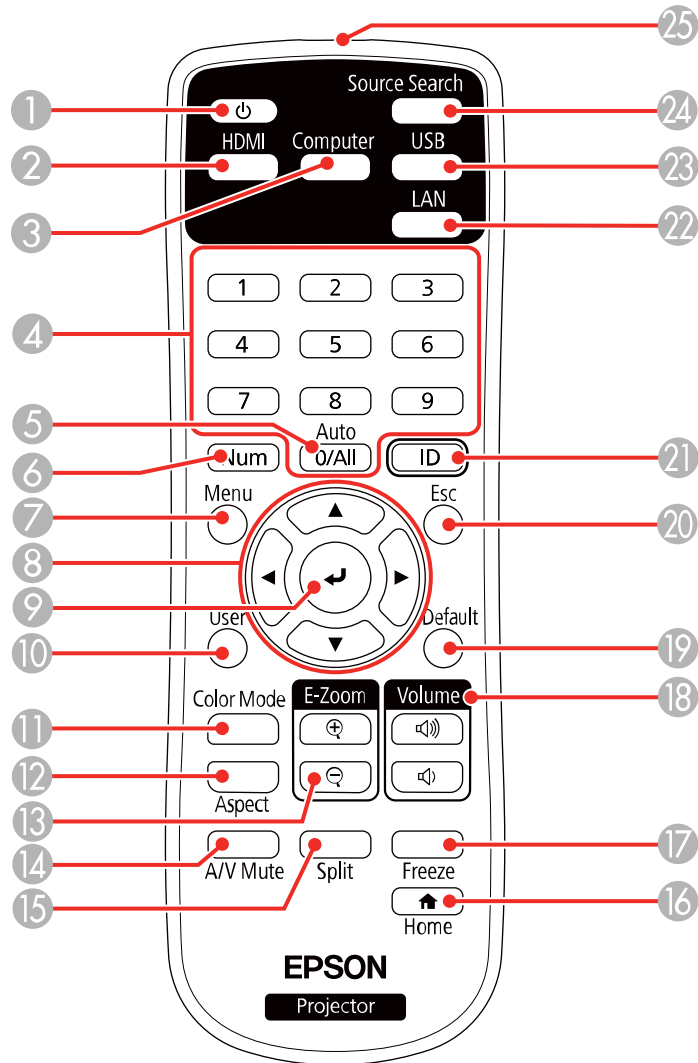

- 1 Power button
- 2 **HDMI** button (cycles through connected HDMI sources)

- 3 **Computer** button
- 4 Numeric buttons
- 5 **Auto** button (automatically adjusts position, tracking, and sync settings)
- 6 **Num** button (when held down, switches numeric buttons to number function)
- 7 **Menu** button (accesses projector menu system)
- 8 Arrow buttons (move through on-screen options)
- 9 ↵ Enter button (selects options)
- 10 **User** button (customizable for different functions)
- 11 **Color Mode** button (selects display modes)
- 12 **Aspect** button (selects the image aspect ratio)
- 13 **E-Zoom +/-** buttons (zoom into and out of the image)
- 14 **A/V Mute** button (turns off picture and sound)
- 15 **Split** button (splits the screen between two image sources)
- 16 🏠 **Home** button (accesses projector Home screen)
- 17 **Freeze** button (stops video action)
- 18 **Volume** up/down buttons (adjust speaker volume)
- 19 **Default** button (resets the selected setting to its default value)
- 20 **Esc** button (cancels/exits functions and controls wireless mouse functions)
- 21 **ID** button (selects a projector to use with the remote control)
- 22 **LAN** button (connects to a network source)
- 23 **USB** button (cycles through connected USB sources)
- 24 **Source Search** button (searches for connected sources)
- 25 Remote control emitter

Parent topic: [Projector Part Locations](#)

Setting Up the Projector

Follow the instructions in these sections to set up your projector for use.

[Projector Placement](#)

[Projector Connections](#)

[Attaching and Removing the Cable Cover](#)

[Installing Batteries in the Remote Control](#)

Projector Placement

You can place the projector on almost any flat surface to project an image.

You can also install the projector in a ceiling mount if you want to use it in a fixed location.

There is no vertical or horizontal limit to how the projector can be installed.

Keep these considerations in mind as you select a projector location:

- Place the projector on a sturdy, level surface or install it using a compatible mount.
- Place the projector parallel to the screen.
- Leave plenty of space around and under the projector for ventilation, and do not place it on top of or next to anything that could block the vents.
- Position the projector within reach of a grounded electrical outlet or extension cord.

[Projector Setup and Installation Options](#)

[Projection Distance](#)

Parent topic: [Setting Up the Projector](#)

Related references

[Important Safety Instructions](#)

Projector Setup and Installation Options

You can set up or install your projector in the following ways:

Front

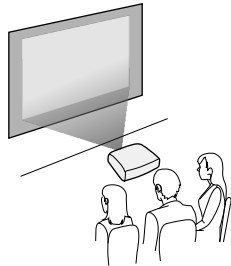

Rear

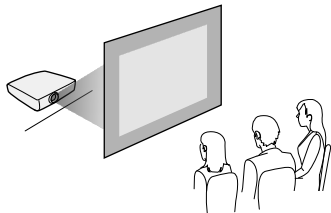

Front ceiling

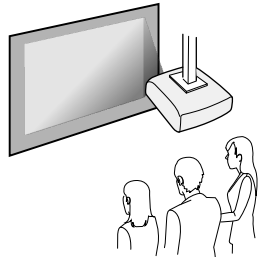

Rear ceiling

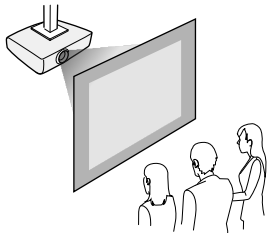

Note: Be sure to leave the following amount of space around the projector to avoid blocking the air exhaust and intake vents.

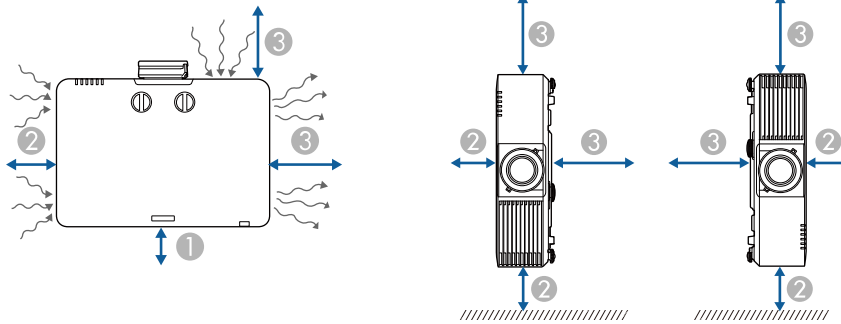

- 1 3.94 inches (10 cm)
- 2 7.87 inches (20 cm)
- 3 15.75 inches (40 cm)

Note: When setting up multiple projectors, be sure to leave the following amount of space between the projectors.

Without a partition

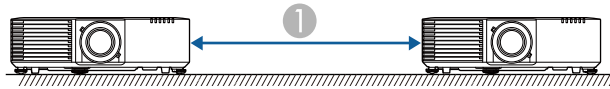

1 59.05 inches (150 cm)

With a partition

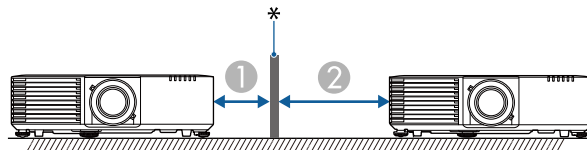

* Partition

1 7.87 inches (20 cm)

2 15.75 inches (40 cm)

If you project from the ceiling or from the rear, be sure to select the correct **Projection** setting in the Installation menu. If necessary, enable the **Inv Direction Button** setting in the Operation menu and adjust the **Menu Rotation** setting in the Display menu.

Parent topic: [Projector Placement](#)

Related references

[Feature Settings - Operation Menu](#)

[Display Settings - Display Menu](#)

[Installation Settings - Installation Menu](#)

[Important Safety Instructions](#)

Projection Distance

The distance at which you place the projector from the screen determines the approximate size of the image. The image size increases the farther the projector is from the screen, but can vary depending on the zoom factor, aspect ratio, and other settings.

Use the tables here to determine approximately how far to place the projector from the screen based on the size of the projected image. (Conversion figures may have been rounded up or down.) You can also use the Projection Distance Calculator [here](#) (U.S.), [here](#) (Canada), or [here](#) (Caribbean).

PowerLite EB-L530U/EB-L630U/EB-L730U/EB-L735U

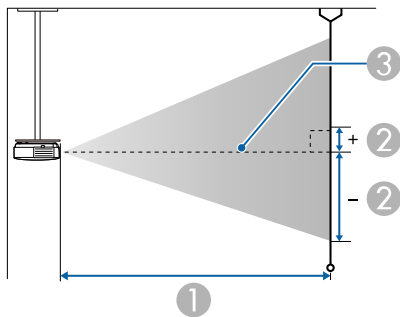
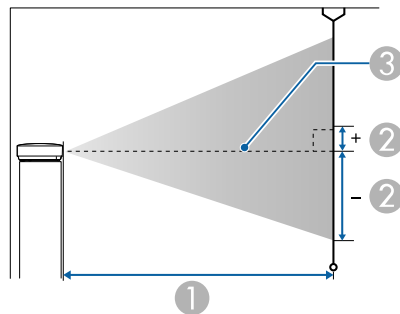

- 1 Projection distance
- 2 Distance from the center of the lens to the base of the screen (this varies depending on vertical lens shift setting)
- 3 Center of lens

16:10 Aspect Ratio Image or Screen		
Screen or image size	Projection distance (1) Wide to Tele	Distance from center of lens to base of screen (2)
50 inches	57 to 93 inches (144 to 235 cm)	-26.5 to 0 inches (-67 to 0 cm)
60 inches	68 to 111 inches (174 to 283 cm)	-31.8 to 0 inches (-81 to 0 cm)
70 inches	80 to 130 inches (204 to 331 cm)	-37.1 to 0 inches (-94 to 0 cm)
80 inches	92 to 149 inches (233 to 378 cm)	-42.4 to 0 inches (-108 to 0 cm)
100 inches	115 to 187 inches (292 to 474 cm)	-53 to 0 inches (-135 to 0 cm)
120 inches	138 to 224 inches (351 to 569 cm)	-63.6 to 0 inches (-162 to 0 cm)
150 inches	173 to 281 inches (440 to 713 cm)	-79.5 to 0 inches (-202 to 0 cm)
200 inches	232 to 375 inches (588 to 951 cm)	-106 to 0 inches (-269 to 0 cm)
300 inches	348 to 563 inches (884 to 1429 cm)	-159 to 0 inches (-404 to 0 cm)
500 inches	581 to 938 inches (1476 to 2384 cm)	-265 to 0 inches (-673 to 0 cm)

4:3 Aspect Ratio Image or Screen		
Screen or image size	Projection distance (1) Wide to Tele	Distance from center of lens to base of screen (2)
45 inches	58 to 94 inches (147 to 240 cm)	-27 to 0 inches (-69 to 0 cm)
50 inches	65 to 105 inches (164 to 267 cm)	-30 to 0 inches (-76 to 0 cm)
60 inches	78 to 126 inches (197 to 321 cm)	-36 to 0 inches (-91 to 0 cm)
70 inches	91 to 148 inches (231 to 375 cm)	-42 to 0 inches (-107 to 0 cm)
80 inches	104 to 169 inches (264 to 429 cm)	-48 to 0 inches (-122 to 0 cm)
100 inches	130 to 211 inches (331 to 537 cm)	-60 to 0 inches (-152 to 0 cm)
120 inches	157 to 254 inches (398 to 645 cm)	-72 to 0 inches (-183 to 0 cm)
150 inches	196 to 318 inches (499 to 807 cm)	-90 to 0 inches (-229 to 0 cm)
200 inches	262 to 424 inches (666 to 1077 cm)	-120 to 0 inches (-305 to 0 cm)
300 inches	394 to 637 inches (1001 to 1618 cm)	-180 to 0 inches (-457 to 0 cm)
440 inches	579 to 935 inches (1470 to 2375 cm)	-264 to 0 inches (-671 to 0 cm)

16:9 Aspect Ratio Image or Screen		
Screen or image size	Projection distance (1) Wide to Tele	Distance from center of lens to base of screen (2)
49 inches	57 to 93 inches (145 to 237 cm)	-25.4 to 1.3 inches (-64 to 3 cm)
50 inches	58 to 95 inches (148 to 242 cm)	-25.9 to 1.4 inches (-66 to 3 cm)
60 inches	70 to 115 inches (179 to 291 cm)	-31 to 1.6 inches (-79 to 4 cm)
70 inches	82 to 134 inches (209 to 340 cm)	-36.2 to 1.9 inches (-92 to 5 cm)
80 inches	94 to 153 inches (240 to 389 cm)	-41.4 to 2.2 inches (-105 to 6 cm)
100 inches	118 to 192 inches (301 to 487 cm)	-51.7 to 2.7 inches (-131 to 7 cm)
120 inches	142 to 230 inches (361 to 585 cm)	-62.1 to 3.3 inches (-158 to 8 cm)
150 inches	178 to 288 inches (453 to 733 cm)	-77.6 to 4.1 inches (-197 to 10 cm)
200 inches	238 to 385 inches (605 to 978 cm)	-103.5 to 5.4 inches (-263 to 14 cm)
300 inches	385 to 578 inches (909 to 1496 cm)	-155.2 to 8.2 inches (-394 to 21 cm)
486 inches	580 to 938 inches (1474 to 2381 cm)	-251.5 to 13.2 inches (-639 to 34 cm)

16:6 Aspect Ratio Image or Screen		
Screen or image size	Projection distance (1) Wide to Tele	Distance from center of lens to base of screen (2)
46 inches	58 to 94 inches (147 to 239 cm)	-21.5 to 5.4 inches (-55 to 14 cm)
50 inches	63 to 102 inches (160 to 260 cm)	-23.4 to 5.9 inches (-59 to 15 cm)
60 inches	76 to 123 inches (192 to 313 cm)	-28.1 to 7 inches (-71 to 18 cm)
70 inches	89 to 144 inches (225 to 366 cm)	-32.8 to 8.2 inches (-83 to 21 cm)
80 inches	101 to 165 inches (258 to 418 cm)	-37.5 to 9.4 inches (-95 to 24 cm)
100 inches	127 to 206 inches (323 to 524 cm)	-46.8 to 11.7 inches (-119 to 30 cm)
120 inches	153 to 248 inches (388 to 629 cm)	-56.2 to 14 inches (-143 to 36 cm)
150 inches	192 to 310 inches (486 to 787 cm)	-70.2 to 17.6 inches (-178 to 45 cm)
200 inches	256 to 414 inches (650 to 1051 cm)	-93.6 to 23.4 inches (-238 to 59 cm)
300 inches	384 to 621 inches (976 to 1578 cm)	-140.4 to 35.1 inches (-357 to 89 cm)
452 inches	580 to 937 inches (1473 to 2379 cm)	-211.6 to 52.9 inches (-537 to 134 cm)

PowerLite EB-L630SU/EB-L635SU

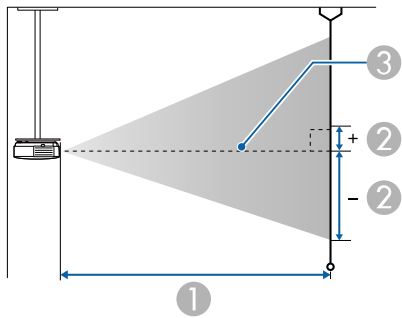
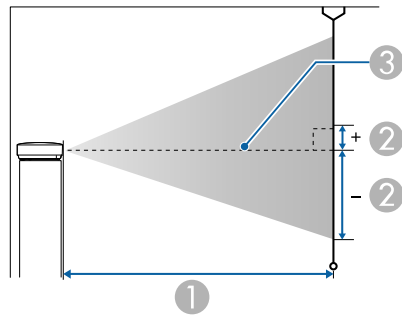

- 1 Projection distance
- 2 Distance from the center of the lens to the base of the screen (this varies depending on vertical lens shift setting)
- 3 Center of lens

Note: Screen sizes with an asterisk (*) may not focus properly.

16:10 Aspect Ratio Image or Screen		
Screen or image size	Projection distance (1) Wide to Tele	Distance from center of lens to base of screen (2)
37 inches	24* to 33 inches (62* to 84 cm)	-19.6 to 0 inches (-50 to 0 cm)
50 inches	33 to 45 inches (85 to 115 cm)	-26.5 to 0 inches (-67 to 0 cm)
60 inches	40 to 55 inches (103 to 139 cm)	-31.8 to 0 inches (-81 to 0 cm)
80 inches	54 to 73 inches (138 to 186 cm)	-42.4 to 0 inches (-108 to 0 cm)
90 inches	61 to 83 inches (156 to 210 cm)	-47.7 to 0 inches (-121 to 0 cm)
100 inches	68 to 92 inches (173 to 234 cm)	-53 to 0 inches (-135 to 0 cm)
148 inches	101 to 137 inches (258 to 348 cm)	-78.4 to 0 inches (-199 to 0 cm)
150 inches	103 to 139* inches (261 to 353* cm)	-79.5 to 0 inches (-202 to 0 cm)
180 inches	124 to 167* inches (314 to 424* cm)	-95.4 to 0 inches (-242 to 0 cm)
200 inches	138 to 186* inches (349 to 472* cm)	-106 to 0 inches (-269 to 0 cm)

4:3 Aspect Ratio Image or Screen		
Screen or image size	Projection distance (1) Wide to Tele	Distance from center of lens to base of screen (2)
33 inches	25* to 33 inches (63* to 85 cm)	-19.8 to 0 inches (-50 to 0 cm)
45 inches	34 to 46 inches (87 to 117 cm)	-27 to 0 inches (-69 to 0 cm)
50 inches	38 to 51 inches (97 to 131 cm)	-30 to 0 inches (-76 to 0 cm)
60 inches	46 to 62 inches (117 to 157 cm)	-36 to 0 inches (-91 to 0 cm)
80 inches	62 to 83 inches (157 to 211 cm)	-48 to 0 inches (-122 to 0 cm)
90 inches	69 to 94 inches (176 to 238 cm)	-54 to 0 inches (-137 to 0 cm)
100 inches	77 to 104 inches (196 to 265 cm)	-60 to 0 inches (-152 to 0 cm)
120 inches	93 to 126 inches (236 to 319 cm)	-72 to 0 inches (-183 to 0 cm)
130 inches	101 to 136 inches (256 to 346 cm)	-78 to 0 inches (-198 to 0 cm)
150 inches	117 to 157* inches (296 to 400* cm)	-90 to 0 inches (-229 to 0 cm)
176 inches	137 to 185* inches (348 to 470* cm)	-105.6 to 0 inches (-268 to 0 cm)

16:9 Aspect Ratio Image or Screen		
Screen or image size	Projection distance (1) Wide to Tele	Distance from center of lens to base of screen (2)
36 inches	24* to 33 inches (62* to 84 cm)	-18.6 to 1.0 inches (-47 to 2 cm)
49 inches	34 to 46 inches (86 to 116 cm)	-25.4 to 1.3 inches (-64 to 3 cm)
50 inches	34 to 47 inches (88 to 118 cm)	-25.9 to 1.4 inches (-66 to 3 cm)
60 inches	42 to 56 inches (106 to 143 cm)	-31 to 1.6 inches (-79 to 4 cm)
80 inches	56 to 75 inches (142 to 191 cm)	-41.4 to 2.2 inches (-105 to 6 cm)
100 inches	70 to 95 inches (178 to 240 cm)	-51.7 to 2.7 inches (-131 to 7 cm)
120 inches	84 to 114 inches (214 to 289 cm)	-62.1 to 3.3 inches (-158 to 8 cm)
144 inches	101 to 137 inches (258 to 348 cm)	-74.5 to 3.9 inches (-189 to 10 cm)
150 inches	106 to 143* inches (269 to 363* cm)	-77.6 to 4.1 inches (-197 to 10 cm)
180 inches	127 to 172* inches (323 to 436* cm)	-93.1 to 4.9 inches (-237 to 12 cm)
194 inches	137 to 185* inches (348 to 470* cm)	-100.4 to 5.3 inches (-255 to 13 cm)

16:6 Aspect Ratio Image or Screen		
Screen or image size	Projection distance (1) Wide to Tele	Distance from center of lens to base of screen (2)
34 inches	25* to 34 inches (63* to 85 cm)	-15.9 to 4 inches (-40 to 10 cm)
46 inches	34 to 46 inches (86 to 117 cm)	-21.5 to 5.4 inches (-55 to 14 cm)
50 inches	37 to 50 inches (94 to 127 cm)	-23.4 to 5.9 inches (-59 to 15 cm)
60 inches	45 to 60 inches (114 to 153 cm)	-28.1 to 7 inches (-71 to 18 cm)
80 inches	60 to 81 inches (153 to 206 cm)	-37.5 to 9.4 inches (-95 to 24 cm)
100 inches	75 to 102 inches (191 to 259 cm)	-46.8 to 11.7 inches (-119 to 30 cm)
120 inches	91 to 122 inches (230 to 311 cm)	-56.2 to 14 inches (-143 to 36 cm))
134 inches	101 to 137 inches (258 to 348 cm)	-62.7 to 15.7 inches (-159 to 40 cm)
150 inches	114 to 153* inches (289 to 390* cm)	-70.2 to 17.6 inches (-178 to 45 cm)
180 inches	137 to 184* inches (347 to 469* cm)	-84.3 to 21.1 inches (-214 to 54 cm)
181 inches	137 to 186* inches (349 to 471* cm)	-84.7 to 21.2 inches (-215 to 54 cm)

PowerLite EB-L520U

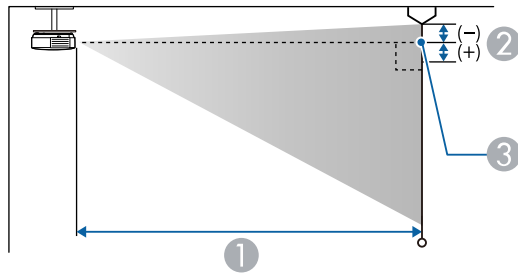
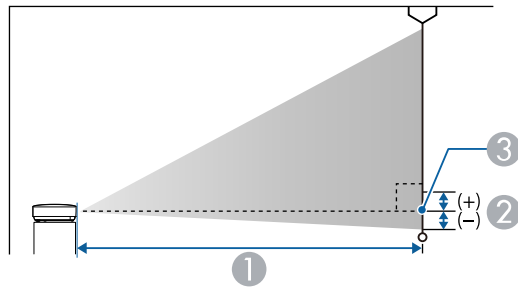

- 1 Projection distance
- 2 Distance from the center of the lens to the base of the screen
- 3 Center of lens

16:10 Aspect Ratio Image or Screen		
Screen or image size	Projection distance (1) Wide to Tele	Distance from center of lens to base of screen (2)
50 inches	57 to 93 inches (144 to 235 cm)	-1 to 25.5 inches (-2 to 65 cm)
60 inches	68 to 111 inches (174 to 283 cm)	-1.1 to 30.7 inches (-3 to 78 cm)

16:10 Aspect Ratio Image or Screen		
Screen or image size	Projection distance (1) Wide to Tele	Distance from center of lens to base of screen (2)
70 inches	80 to 130 inches (204 to 331 cm)	-1.3 to 35.8 inches (-3 to 91 cm)
80 inches	92 to 149 inches (233 to 378 cm)	-1.5 to 40.9 inches (-4 to 104 cm)
100 inches	115 to 187 inches (292 to 474 cm)	-1.9 to 51.1 inches (-5 to 130 cm)
120 inches	138 to 224 inches (351 to 569 cm)	-2.3 to 61.3 inches (-6 to 156 cm)
150 inches	173 to 281 inches (440 to 713 cm)	-2.9 to 76.6 inches (-7 to 195 cm)
200 inches	232 to 375 inches (588 to 951 cm)	-3.8 to 102.2 inches (-10 to 260 cm)
300 inches	348 to 563 inches (884 to 1429 cm)	-5.7 to 153.3 inches (-14 to 389 cm)
500 inches	581 to 938 inches (1476 to 2384 cm)	-9.5 to 255.5 inches (-24 to 649 cm)

4:3 Aspect Ratio Image or Screen		
Screen or image size	Projection distance (1) Wide to Tele	Distance from center of lens to base of screen (2)
45 inches	58 to 94 inches (147 to 240 cm)	-1 to 26 inches (-2 to 66 cm)
50 inches	65 to 105 inches (164 to 267 cm)	-1.1 to 28.9 inches (-3 to 73 cm)

4:3 Aspect Ratio Image or Screen		
Screen or image size	Projection distance (1) Wide to Tele	Distance from center of lens to base of screen (2)
60 inches	78 to 126 inches (197 to 321 cm)	-1.3 to 34.7 inches (-3 to 88 cm)
70 inches	91 to 148 inches (231 to 375 cm)	-1.5 to 40.5 inches (-4 to 103 cm)
80 inches	104 to 169 inches (264 to 429 cm)	-1.7 to 46.3 inches (-4 to 118 cm)
100 inches	130 to 211 inches (331 to 537 cm)	-2.2 to 57.8 inches (-5 to 147 cm)
120 inches	157 to 254 inches (398 to 645 cm)	-2.6 to 69.4 inches (-7 to 176 cm)
150 inches	196 to 318 inches (499 to 807 cm)	-3.2 to 86.8 inches (-8 to 220 cm)
200 inches	262 to 424 inches (666 to 1077 cm)	-4.3 to 115.7 inches (-11 to 294 cm)
300 inches	394 to 637 inches (1001 to 1618 cm)	-6.5 to 173.5 inches (-16 to 441 cm)
440 inches	579 to 935 inches (1470 to 2375 cm)	-9.5 to 254.5 inches (-24 to 646 cm)

16:9 Aspect Ratio Image or Screen		
Screen or image size	Projection distance (1) Wide to Tele	Distance from center of lens to base of screen (2)
49 inches	57 to 93 inches (145 to 237 cm)	-0.4 to 24.4 inches (-1 to 62 cm)

16:9 Aspect Ratio Image or Screen		
Screen or image size	Projection distance (1) Wide to Tele	Distance from center of lens to base of screen (2)
50 inches	58 to 95 inches (148 to 242 cm)	-0.4 to 24.9 inches (-1 to 63 cm)
60 inches	70 to 115 inches (179 to 291 cm)	-0.5 to 29.9 inches (-1 to 76 cm)
70 inches	82 to 134 inches (209 to 340 cm)	-0.5 to 34.9 inches (-1 to 89 cm)
80 inches	94 to 153 inches (240 to 389 cm)	-0.6 to 39.8 inches (-2 to 101 cm)
100 inches	118 to 192 inches (301 to 487 cm)	-0.8 to 49.8 inches (-2 to 126 cm)
120 inches	142 to 230 inches (361 to 585 cm)	-0.9 to 59.8 inches (-2 to 152 cm)
150 inches	178 to 288 inches (453 to 733 cm)	-1.2 to 74.7 inches (-3 to 190 cm)
200 inches	238 to 385 inches (605 to 978 cm)	-1.5 to 99.6 inches (-4 to 253 cm)
300 inches	385 to 578 inches (909 to 1496 cm)	-2.3 to 149.4 inches (-6 to 379 cm)
486 inches	580 to 938 inches (1474 to 2381 cm)	-3.7 to 242 inches (-9 to 615 cm)

16:6 Aspect Ratio Image or Screen		
Screen or image size	Projection distance (1) Wide to Tele	Distance from center of lens to base of screen (2)
46 inches	58 to 94 inches (147 to 239 cm)	-4.4 to 20.6 inches (-11 to 52 cm)
50 inches	63 to 102 inches (160 to 260 cm)	-4.8 to 22.4 inches (-12 to 57 cm)
60 inches	76 to 123 inches (192 to 313 cm)	-5.8 to 26.8 inches (-15 to 68 cm)
70 inches	89 to 144 inches (225 to 366 cm)	-6.7 to 31.3 inches (-17 to 80 cm)
80 inches	101 to 165 inches (258 to 418 cm)	-7.7 to 35.8 inches (-20 to 91 cm)
100 inches	127 to 206 inches (323 to 524 cm)	-9.6 to 44.7 inches (-24 to 114 cm)
120 inches	153 to 248 inches (388 to 629 cm)	-11.5 to 53.7 inches (-29 to 136 cm)
150 inches	192 to 310 inches (486 to 787 cm)	-14.4 to 67.1 inches (-37 to 170 cm)
200 inches	256 to 414 inches (650 to 1051 cm)	-18.2 to 89.4 inches (-49 to 227 cm)
300 inches	384 to 621 inches (976 to 1578 cm)	-28.8 to 134.1 inches (-73 to 341 cm)
452 inches	580 to 937 inches (1473 to 2379 cm)	-43.4 to 202.1 inches (-110 to 513 cm)

Parent topic: [Projector Placement](#)

Projector Connections

See these sections to connect the projector to a variety of projection sources.

Caution: If you will use the projector at altitudes above 4921 feet (1500 m), turn on **High Altitude Mode** to ensure the projector's internal temperature is regulated properly.

Caution: Check the shape and orientation of the connectors on any cable you plan to connect. Do not force a connector into a port if it does not fit. The device or your projector could be damaged or could malfunction.

[Connecting to Computer Sources](#)

[Connecting to Video Sources](#)

[Connecting to a USB Device](#)

[Connecting to a Streaming Media Player](#)

[Connecting to a Document Camera](#)

[Connecting to an HDBaseT Transmitter](#)

[Connecting to an External Computer Monitor](#)

[Connecting to External Speakers](#)

[Connecting Multiple Projectors of the Same Model](#)

Parent topic: [Setting Up the Projector](#)

Related references

[Installation Settings - Installation Menu](#)

Connecting to Computer Sources

Follow the instructions in these sections to connect a computer to the projector.

[Connecting to a Computer for VGA Video and Audio](#)

[Connecting to a Computer for HDMI Video and Audio](#)

Parent topic: [Projector Connections](#)

Connecting to a Computer for VGA Video and Audio

You can connect the projector to your computer using a VGA computer cable. You can play sound through the projector's speaker system by connecting a commercially available 3.5 mm stereo mini-jack audio cable.

Note: To connect a Mac that includes only a Mini DisplayPort, Thunderbolt port, or Mini-DVI port for video output, you need to obtain an adapter that allows you to connect to the projector's VGA video port. Contact Apple for compatible adapter options.

Note: To project an image source connected to the **Computer2/Monitor Out** port, set **Monitor Out Port to Computer2** in the projector's Signal I/O menu. You can also set the port to input audio when projecting the computer source as the **Audio Output** setting in the projector's Signal I/O menu. Make sure the audio cable is labeled "No resistance."

1. If necessary, disconnect your computer's monitor cable.
2. Connect the VGA computer cable to your computer's monitor port.
3. Connect the other end to a **Computer** port on the projector.

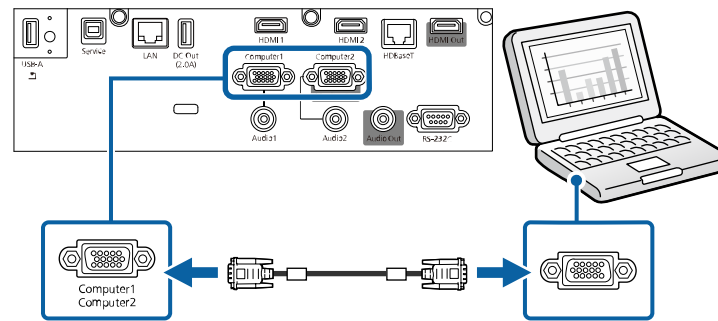

4. Tighten the screws on the VGA connector.
5. Connect an audio cable to your laptop's headphone or audio out jack, or your desktop's speaker or audio out port.

6. Connect the other end to the **Audio** port that corresponds to the **Computer** port you are using.

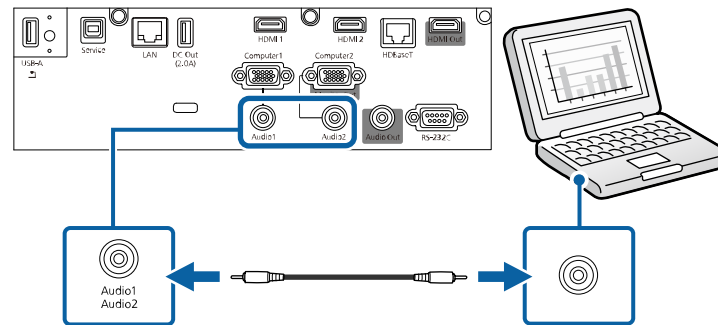

Parent topic: [Connecting to Computer Sources](#)

Related references

[Input Signal Settings - Signal I/O Menu](#)

Connecting to a Computer for HDMI Video and Audio

If your computer has an HDMI port, you can connect it to the projector using an optional HDMI cable.

Note: To connect a Mac that includes only a Mini DisplayPort, Thunderbolt port, or Mini-DVI port for video output, you need to obtain an adapter that allows you to connect to the projector's **HDMI** port. Contact Apple for compatible adapter options. Older Mac computers (2009 and earlier) may not support audio through the **HDMI** port.

1. Connect the HDMI cable to your computer's HDMI output port.
2. Connect the other end to one of the projector's HDMI ports.

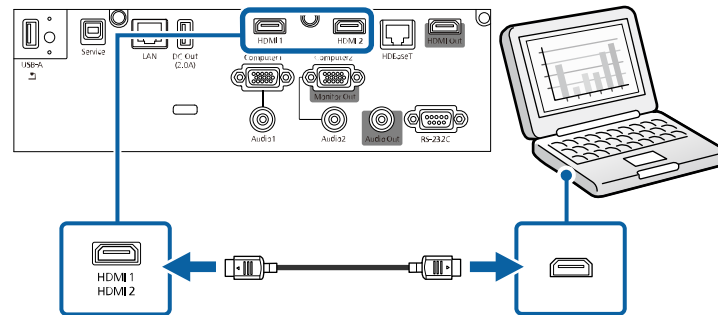

Note: If you have problems hearing audio through the HDMI connection, connect one end of an optional 3.5 mm stereo mini-jack audio cable to the projector's **Audio** port and the other end to your computer's audio out port. Then select the audio port you connected to as the **HDMI Audio Output** setting in the Signal I/O menu.

Parent topic: [Connecting to Computer Sources](#)

Related references

[Input Signal Settings - Signal I/O Menu](#)

Connecting to Video Sources

Follow the instructions in these sections to connect video devices to the projector.

[Connecting to an HDMI Video Source](#)

Parent topic: [Projector Connections](#)

Connecting to an HDMI Video Source

If your video source has an HDMI port, you can connect it to the projector using an optional HDMI cable. The HDMI connection provides the best image quality.

Caution: Do not turn on the video source before connecting it to the projector. Doing so could damage the projector.

1. Connect the HDMI cable to your video source's HDMI output port.
2. Connect the other end to one of the projector's **HDMI** ports.

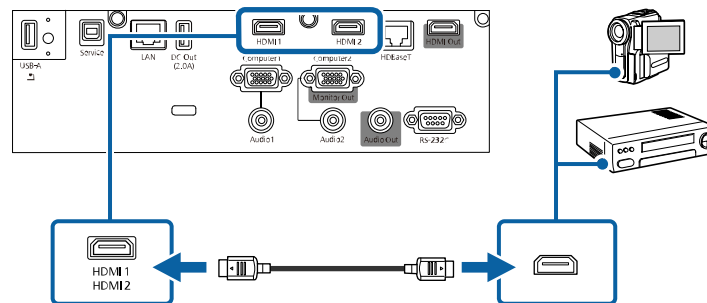

Note: If you have problems hearing audio through the HDMI connection, you can use one of the projector's audio ports instead to play sound. Connect one end of an optional 3.5 mm stereo mini-jack

audio cable to one of the projector's audio ports and the other end to your computer's audio out port. Then select the audio port you connected to as the **HDMI Audio Output** setting in the Signal I/O menu.

Parent topic: [Connecting to Video Sources](#)

Related references

[Input Signal Settings - Signal I/O Menu](#)

Connecting to a USB Device

You can connect a USB device or cable to the projector's USB-A port to project images from the device. Use the USB cable supplied with the device.

Note: Do not connect a USB hub or a USB cable longer than 9.8 feet (3 m), or the device may not operate correctly.

Make sure the USB device meets the following requirements:

- The device must be a USB flash drive, USB hard drive, or a digital camera or smartphone
 - Digital cameras and smartphones must be USB-mounted devices (not TWAIN-compliant) and must be USB Mass Storage Class compliant.
 - USB hard drives must be USB Mass Storage Class compliant (not all compliant devices are supported); formatted in FAT16/32; self-powered by their own AC power supplies (bus powered drives are not recommended); and should not have multiple partitions.
1. If your USB device came with an AC adapter, plug the device into an electrical outlet.
 2. Connect the USB device or cable to the projector's **USB-A** port.

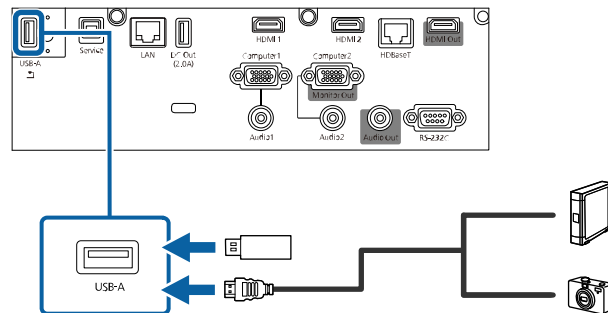

3. If you connected a USB cable, connect the other end to the USB device as necessary.

The projector displays images stored on the USB device.

If you turned on the **Content Playback** setting in the Operation menu, you can only view images that have been added to a playlist created in Epson Projector Content Manager.

Parent topic: [Projector Connections](#)

Related references

[Feature Settings - Operation Menu](#)

Related tasks

[Starting a PC Free Slideshow](#)

[Starting a PC Free Movie Presentation](#)

Connecting to a Streaming Media Player

You can connect a streaming media player to the projector's HDMI port. By connecting the streaming media player's power supply USB cable, you can power the streaming media player from the projector.

Note: The **DC Out (2.0A)** port is not available on the PowerLite EB-L520U. You will have to power the streaming media player from another source.

1. Connect the streaming media player to an **HDMI** port.

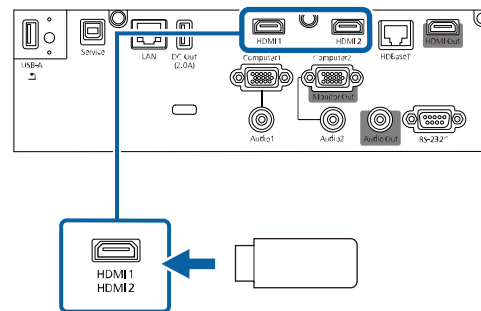

2. If necessary, connect the streaming media player's USB power supply cable to the **DC Out (2.0A)** port. Connect the other end of the cable to the USB port on the streaming media player.

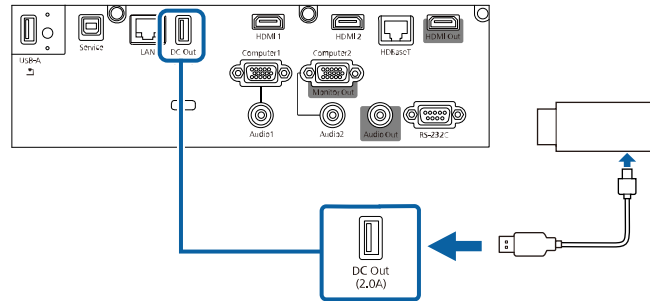

Note: To keep supplying power to the optional streaming media player when the projector is not projecting images, select **Always On** as the **USB Power** setting in the projector's Operation menu.

Parent topic: [Projector Connections](#)

Related references

[Feature Settings - Operation Menu](#)

Connecting to a Document Camera

You can connect a document camera to your projector to project images from the camera.

Note: The connection method varies depending on your document camera model. For additional features supported by software, connect your document camera to your computer using the camera's USB port instead of connecting the camera to the projector. See the document camera manual for details.

Parent topic: [Projector Connections](#)

Related references

[Optional Equipment and Replacement Parts \(U.S. and Canada\)](#)

[Optional Equipment and Replacement Parts \(Latin America\)](#)

Connecting to an HDBaseT Transmitter

To send an HDMI or RS-232C signal over a long distance, you can connect the projector to an optional HDBaseT transmitter using a 100Base-TX network cable. This is useful when you want to send a signal

to or control the projector from a remote location, such as in a hall or event site, since you can use a network cable up to 328 feet (100 m) in length. To ensure proper data transmission, use a Category 5e STP cable or better.

Note: Set the **A/V Output** setting to **Always On** in the Signal I/O menu to control the projector when it is not projecting any images.

1. Turn off the projector and HDBaseT transmitter.

Note: Make sure the projector and HDBaseT transmitter are turned off when connecting or disconnecting a network cable between the two devices.

2. Connect one end of the network cable to the **HDBaseT** port on the transmitter.
3. Connect the other end to the projector's **HDBaseT** port.

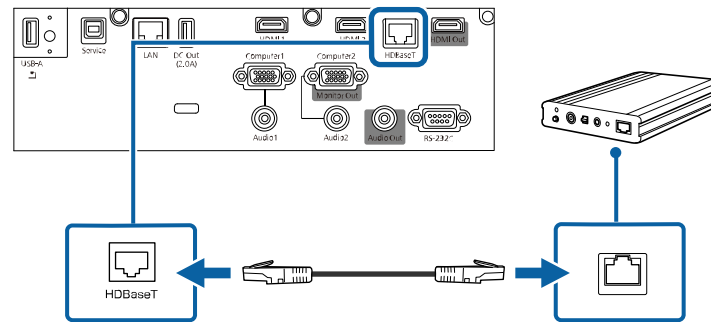

Note: See the documentation that came with the HDBaseT transmitter for instructions on connecting it to your video device or computer.

4. Turn on the projector and HDBaseT transmitter.

Note: To enable communication from the Ethernet and serial ports on the transmitter, enable **Control Communications** in the HDBaseT settings of the projector's Signal I/O menu. Turning on this setting disables the projector's **LAN** and **RS-232C** ports. If you connected an Extron XTP transmitter or switcher to the projector's **HDBaseT** port, select **On** as the **Extron XTP** setting in the projector's Signal I/O menu.

Parent topic: [Projector Connections](#)

Related references

[Input Signal Settings - Signal I/O Menu](#)

Connecting to an External Computer Monitor

If you connected a computer to the projector's **Computer** port, you can also connect an external monitor to the projector. This lets you see your presentation on the external monitor even when the projected image is not visible.

If you want to output images to an external monitor when the projector is turned off, you need to select **Always On** as the **A/V Output** setting in the projector's Signal I/O menu.

Note: Monitors that use a refresh rate less than 60 Hz may not be able to display images correctly.

1. Make sure your computer is connected to the projector's **Computer1** port. If there are two computer ports, make sure you use the **Computer1** port.
2. Connect the external monitor's cable to your projector's **Monitor Out** port.

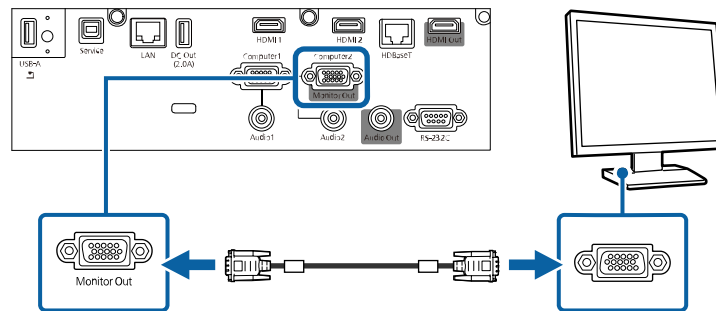

Note: You can only output analog RGB signals from the Computer1 port to an external monitor. You cannot output signals from other ports.

Parent topic: [Projector Connections](#)

Related references

[Feature Settings - Operation Menu](#)

Connecting to External Speakers

You can connect the projector to external self-powered speakers and control the volume using the projector's remote control.

You can also connect the projector to an amplifier with speakers.

Set the **Audio Out Device** setting to **AV System** in the projector's Signal I/O > **HDMI Link** menu. When an audio/video system is not connected to the projector, audio is output from the external speakers even if **Audio Out Device** is set to **AV System**.

If you want to output audio from the external speakers when the projector is turned off, you need to select **Always On** as the **AV Output** setting in the projector's Signal I/O menu.

Note: The projector's built-in speaker system is disabled when you connect external speakers.

1. Make sure your computer or video source is connected to the projector with both audio and video cables as necessary.
2. Locate the appropriate cable to connect your external speakers, such as a stereo mini-jack-to-pin-jack cable, or another type of cable or adapter.
3. Connect one end of the cable to your external speakers as necessary.
4. Connect the stereo mini-jack end of the cable to your projector's **Audio Out** port.

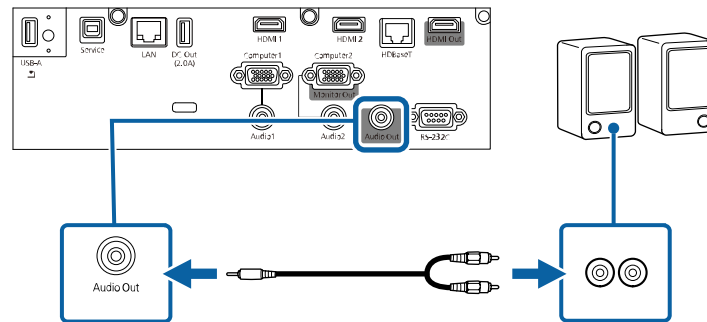

Parent topic: [Projector Connections](#)

Related references

[Input Signal Settings - Signal I/O Menu](#)

Connecting Multiple Projectors of the Same Model

You can connect up to four projectors of the same model in the same room to project a single unified image (not available on the PowerLite EB-L520U). If you are creating one large image vertically or connecting five or more projectors, use the **Tiling** setting in the projector's **Multi-Projection** menu.

1. Connect the computer and the projectors using HDMI cables as shown. If you are connecting the HDBaseT transmitter instead of a computer, use a network cable to connect it to the HDBaseT port.

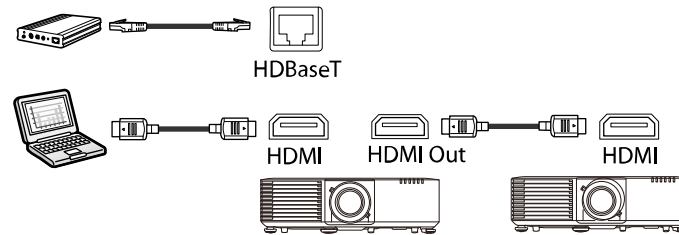

Note: If you are connecting three or more projectors, connect the projectors in a chain as shown.

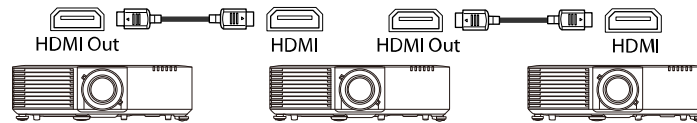

2. After making the appropriate connections, you need to adjust the necessary projector menu settings accordingly. Click the link below.

[Multiple Projector Connection Menu Settings](#)

Parent topic: [Projector Connections](#)

Related references

[Multiple Projector Operation Settings - Multi-Projection Menu](#)

Related tasks

[Configuring Tiling Manually](#)

Multiple Projector Connection Menu Settings

After connecting multiple projectors to project a unified image, see the tables below to select the correct projector menu settings. Make sure your computer is connected to Projector 1 (the left-most projector in your setup).

Note: You may need to restart the projector during the process. Follow any on-screen instructions.

Setup (2-4 Projectors)

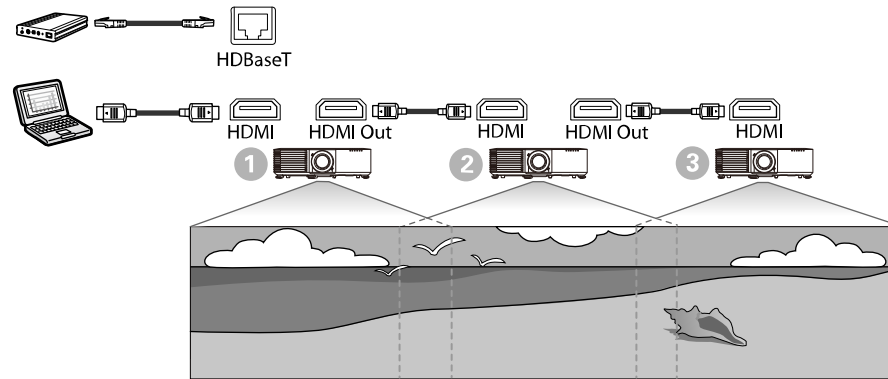

Setting	Projector 1	Projectors 2-4
Image Menu		
Color Mode	Multi-Projection	Multi-Projection
Multi-Projection Menu		
HDMI Out Setting	Pass Through	Pass Through
Number of Projectors	Specify the number of projectors connected in a series	
Order	Specify the position of the projectors in number order from left to right	

Parent topic: [Connecting Multiple Projectors of the Same Model](#)

Related references

[Multiple Projector Operation Settings - Multi-Projection Menu](#)

Related tasks

[Configuring Tiling Manually](#)

Attaching and Removing the Cable Cover

You can attach the cable cover that came with your projector to hide the attached cables from view (not available on the PowerLite EB-L520U).

1. Bundle the cables together using a band or other fastener (not provided).

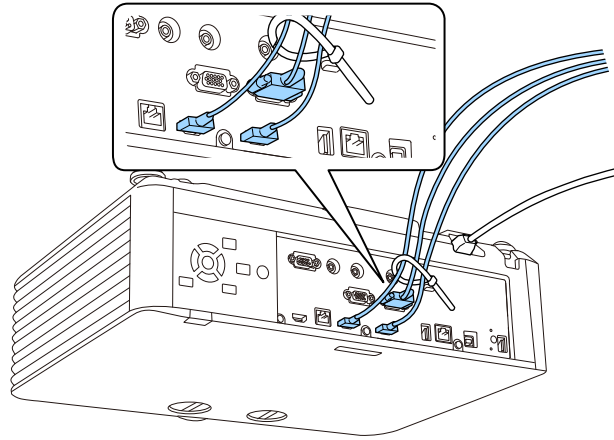

Caution: Do not bundle the power cord to the other cables. Otherwise, a fire may occur.

2. Place the cable cover on the projector as shown, guiding the cables through the notch on the base of the cable cover.

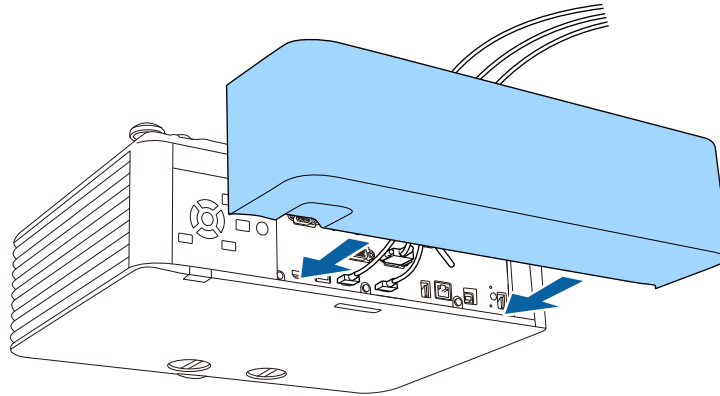

3. Tighten both cable cover screws.

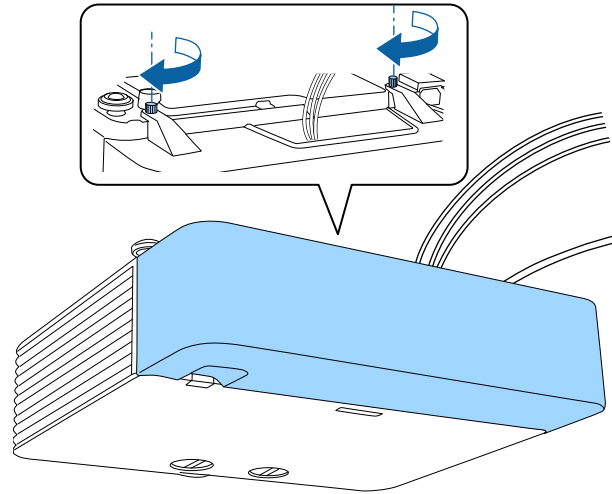

To remove the cover, loosen both screws and pull the cover off of the projector.

Parent topic: [Setting Up the Projector](#)

Installing Batteries in the Remote Control

The remote control uses the two AA batteries that came with the projector.

Caution: Use only the type of batteries specified in this manual. Do not install batteries of different types, or mix new and old batteries.

1. Remove the battery cover.

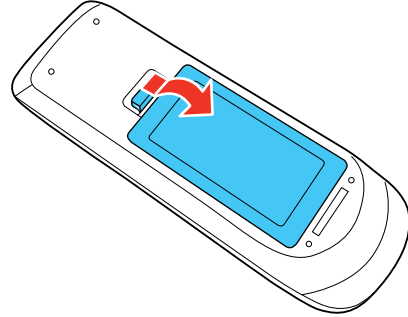

2. Insert the batteries with the + and – ends facing as shown.

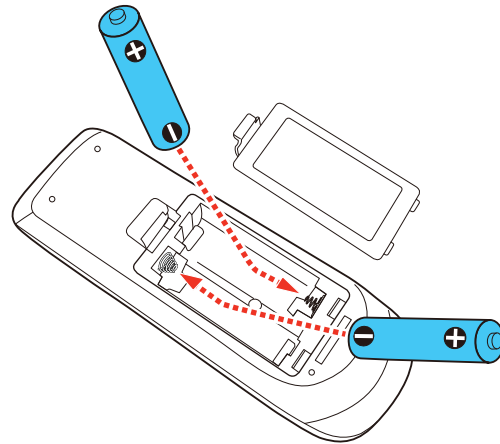

Warning: Make sure the batteries are inserted in the correct positions. If the batteries are not inserted correctly, they could explode or leak, causing a fire, injury, or damage to the product.

3. Replace the battery cover and press it down until it clicks into place.

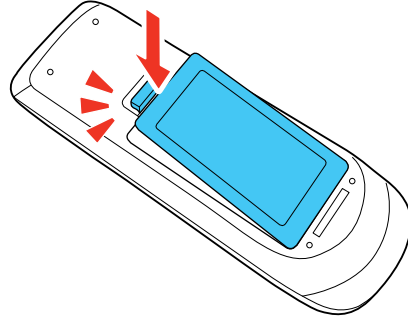

Warning: Dispose of used batteries according to local regulations. Do not expose batteries to heat or flame. Keep batteries out of the reach of children; they are choking hazards and are very dangerous if swallowed.

Parent topic: [Setting Up the Projector](#)

Using the Projector on a Network

Follow the instructions in these sections to set up your projector for use on a network.

Note: Epson iProjection is not recommended for use with streaming video.

[Wired Network Projection](#)

[Wireless Network Projection](#)

[Screen Sharing](#)

[Setting Up Projector Network E-Mail Alerts](#)

[Setting Up Monitoring Using SNMP](#)

[Controlling a Networked Projector Using a Web Browser](#)

[Controlling a Networked Projector in Content Playback Mode](#)

[Using Crestron Connected](#)

[Setting Up Web API](#)

[Secure HTTP](#)

[Registering a Digital Certificate on the Projector](#)

Wired Network Projection

You can project through a wired network. To do this, you connect the projector to your network with an Ethernet cable, and then set up your projector and computer for network projection.

You can use Epson iProjection to project static images and presentations over a wired network.

Note: Epson iProjection is not recommended for use with streaming video.

After connecting and setting up the projector, install the projector software. You may need to install it from a software CD, if included, or download the software and manuals as necessary.

Note: If your projector is connected via a LAN (Ethernet) cable to a network that includes a wireless access point, you can connect to the projector wirelessly through the access point using the Epson network software.

[Connecting to a Wired Network](#)

[Selecting Wired Network Settings](#)

Parent topic: [Using the Projector on a Network](#)

Connecting to a Wired Network

To connect the projector to a wired local area network (LAN), use a 100Base-TX or 10Base-T network cable. To ensure proper data transmission, use a Category 5 shielded cable or higher.

1. Connect one end of the network cable to your network hub, switch, or router.
2. Connect the other end of the cable to the projector's **LAN** port.

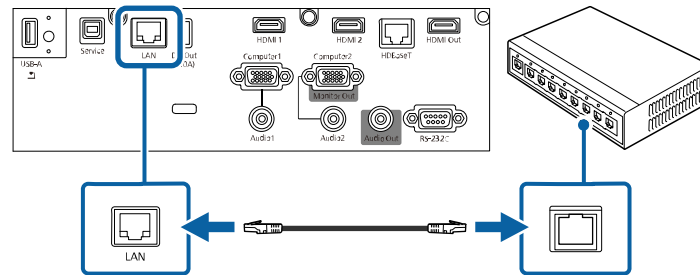

Parent topic: [Wired Network Projection](#)

Selecting Wired Network Settings

Before you can project from computers on your network, you must select the network settings for the projector using its menu system.

Note: Make sure you already connected the projector to your wired network using the **LAN** port.

1. Turn on the projector.
2. Press the **Menu** button.

3. Select the **Network** menu and press **↵ Enter**.

Frequently Used Items	Network	
Image	Wireless LAN Info.	
Signal I/O	Wired LAN Info.	
Installation	Network Settings	
Display	Transmitter Settings	
Operation	Reset Network Settings	
Management	Multi-Projection	
Network	Projector ID	Off
Multi-Projection	HDMI Out Setting	Off
Memory	Tiling	
Initial/All Settings	Geometry Correction	Point Correction
	Edge Blending	
	Scale	
	Color Uniformity	
	Light Source Mode	Normal
	Color Matching	
	RGBCMY	
	Reset Multi-Projection Settings	

4. Select **Network Settings** and press **↵ Enter**.
5. Select **Projector Name** and enter a name up to 16 alphanumeric characters long to identify the projector on a network.
6. Set the **Priority Control Interface** setting to **Wired LAN**.
7. Select the **Wired LAN** menu and press **↵ Enter**.
8. Select **IP Settings** and press **↵ Enter**.
9. Select your IP settings as necessary:
 - If your network assigns addresses automatically, turn on the **DHCP** setting.
 - If you must set addresses manually, turn off **DHCP** and enter the projector's **IP Address**, **Subnet Mask**, and **Gateway Address** as needed.

Note: To highlight the numbers you want from the displayed keyboard, press the arrow buttons on the remote control. To select a highlighted number, press **↵ Enter**. Alternatively, press and hold the **Num** button on the remote control while entering the desired numbers.

10. To prevent display of the IP address on the standby screen, turn off **IP Address Display** in the Wired LAN menu.
11. Select **Return** and press **↩ Enter** to return to the Network Settings menu.
12. Select **Network Projection** and press **↩ Enter**.

You see a screen like this:

[Network Projection]		Return
Projector Keyword	Off	
Epson iProjection	On	^
SSID Display	On	
Display LAN Info.	Text & QR Code	
Moderator Password		
Keyword Interrupt Display	Off	
Screen Mirroring	On	^
Interrupt Connection	On	
Adjust Image Quality	1 (Fine)	
HDMI Out Image Output	Off	
Screen Mirroring Info.	On	
Message Broadcasting	Off	
Screen Sharing	On	^
Connection Mode	Keyword On	

13. Set the **Epson iProjection** setting to **On**.
14. Select the following options as necessary:
 - **SSID Display** lets you display the SSID on the network information screen and home screen.
 - **Display LAN Info** lets you select how the projector displays network information. You can select an option to display a QR code that lets you quickly connect your iOS or Android devices using the Epson iProjection app.

- **Moderator Password** lets you enter a password up to 4 numbers long for accessing the projector as a moderator with the Epson iProjection (Windows/Mac) software or the Epson iProjection app. (No default password.)
- **Keyword Interrupt Display** lets you select whether to display a projector keyword on the projected image when accessing the projector using Epson iProjection.

Note: Use the displayed keyboard to enter the password and keyword. Press the arrow buttons on the remote control to highlight characters and press **↵ Enter** to select them.

15. When you finish selecting settings, select **Return** and press **↵ Enter** to return the **Network Settings** menu.
16. Select **Set**, and follow the on-screen instructions to save your settings and exit the menus.

Parent topic: [Wired Network Projection](#)

Related references

[Network Settings - Network Menu](#)

Wireless Network Projection

You can project over a wireless network. To do this, you must set up your projector and computer for wireless projection.

Note: The Epson 802.11b/g/n wireless LAN module is not included with the PowerLite EB-L520U. The wireless module is built-in for the PowerLite EB-L530U/EB-L630U/EB-L630SU/EB-L635SU/EB-L730U/EB-L735U.

There are two ways to connect to your projector wirelessly:

- Creating a Quick Wireless Connection USB Key (Windows only) using the Epson iProjection software
- Configuring the connection manually using the projector's Network menus

After connecting and setting up the projector, install the projector software. You may need to install it from a software CD, if included, or download the software and manuals as necessary.

You can use Epson iProjection to project static images and presentations over a wireless network.

Note: Epson iProjection is not recommended for use with streaming video.

[Installing the Wireless LAN Module](#)
[Using Quick Wireless Connection \(Windows\)](#)

[Selecting Wireless Network Settings Manually](#)
[Selecting Wireless Network Settings in Windows](#)
[Selecting Wireless Network Settings on Mac](#)
[Setting Up Wireless Network Security](#)
[Using a QR Code to Connect a Mobile Device](#)
[Wireless Network Projection from a Mobile Device or Windows Computer \(Screen Mirroring\)](#)

Parent topic: [Using the Projector on a Network](#)

Related references

[Additional Projector Software and Manuals](#)
[Network Settings - Network Menu](#)

Installing the Wireless LAN Module

To use additional wireless connections (PowerLite EB-L530U/EB-L630U/EB-L630SU/EB-L635SU/EB-L730U/EB-L735U) and to use the projector over a wireless network (PowerLite EB-L520U), install the optional Epson wireless LAN module. Do not install any other type of wireless LAN module.

Caution: Never remove the module while its indicator light is blue or flashing, or while you are projecting wirelessly. You may damage the module or lose data.

Note: The indicator on the wireless LAN module does not operate. See the wireless LAN indicator on the projector to check the wireless LAN status.

1. Turn off the projector and unplug the power cord.
2. Use a Phillips-head screwdriver to remove the screw securing the wireless LAN module cover, then remove the cover.

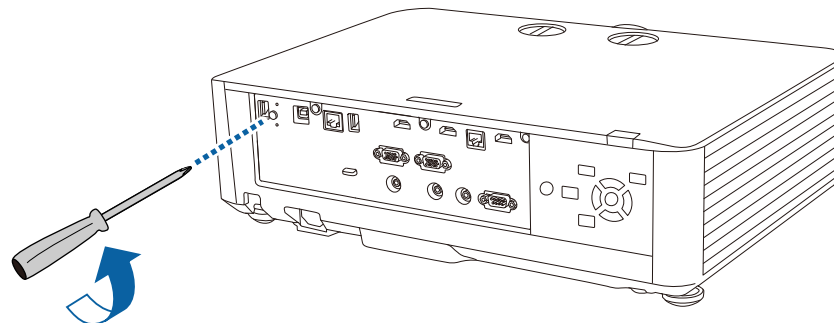

3. Insert the wireless LAN module into the **USB-A** port.

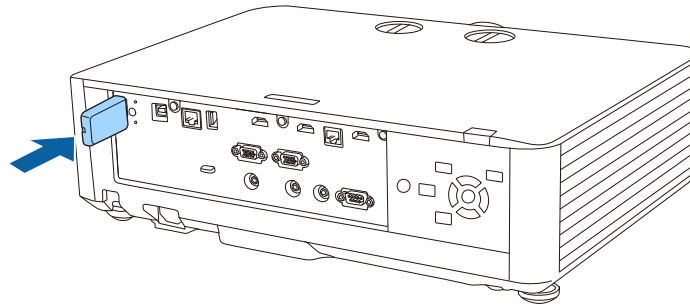

4. Replace the wireless LAN module cover and secure it using the screw you removed.

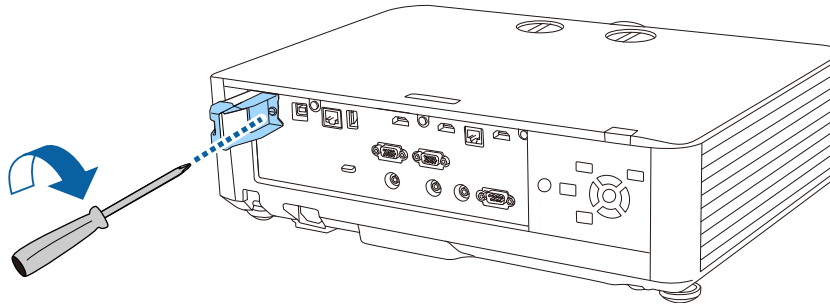

5. Plug in and turn on the projector.

Parent topic: [Wireless Network Projection](#)

Related references

[Projector Light Status](#)

Related tasks

[Turning Off the Projector](#)

[Selecting Wireless Network Settings Manually](#)

Using Quick Wireless Connection (Windows)

You can create a Quick Wireless Connection USB Key to quickly connect the projector to a Windows computer wirelessly. Then you can project your presentation and remove the key when you are done.

Note: A USB flash drive is not included with your projector.

1. Create a Quick Wireless Connection USB Key with a USB flash drive and the Epson iProjection (Windows/Mac) software.

Note: See the *Epson iProjection Operation Guide (Windows/Mac)* for instructions.

2. Turn on the projector.
3. Press the **LAN** button on the remote control.
You see the LAN standby screen.
4. Verify that an SSID and IP address are displayed.
5. Remove the wireless LAN module from the projector's **USB-A** port (if installed) and insert the USB key into the same port.

You see a projected message that the network information update is complete.

6. Remove the USB key.
7. Reinsert the wireless LAN module into the projector, if necessary
8. Insert the USB key into a USB port on your computer.

Note: In Windows Vista, if you see the AutoPlay window, select **Run MPPLaunch.exe**, and select **Allow** on the next screen.

9. Follow the on-screen instructions to install the Epson iProjection (Windows/Mac) software.

Note: If you see a Windows Firewall message, click **Yes** to disable the firewall. You need administrator authority to install the software. If it is not installed automatically, double-click **MPPLaunch.exe** in the USB key.

After a few minutes, your computer image is displayed by the projector. If it does not appear, press the **LAN** or **Source Search** button on your remote control or restart your computer.

10. Run your presentation as necessary.
11. When you finish projecting wirelessly, select the **Safely Remove Hardware** option in the Windows taskbar, then remove the USB key from your computer.

Note: You can share the USB key with other computers without disconnecting your computer. You may need to restart your computer to reactivate your wireless LAN connection.

Parent topic: [Wireless Network Projection](#)

Selecting Wireless Network Settings Manually

Before you can project from your wireless network, you must select the network settings for the projector using its menu system.

1. Turn on the projector.
2. Press the **Menu** button.
3. Select the **Management** menu and press **↵ Enter**.

Frequently Used Items	Management	
Image	User Button	Light Source Mode
Signal I/O	User's Logo	
Installation	Control Panel Lock	Off
Display	Color Uniformity	
Operation	Refresh Mode	
Management	Light Source Calibration	
Network	Date & Time	
Multi-Projection	Schedule Settings	
Memory	Wireless LAN Power	
Initial/All Settings	Wireless LAN Diagnosis	1
	Log Save Destination	USB and Internal Memory
	Batch Setup Range	
	Language 	English
	Information	
	Display Logs	
	Reset Management Settings	
	Network	

4. Select **On** as the **Wireless LAN Power** setting.

5. Select the **Network** menu and press **↵ Enter**.

Frequently Used Items	Network	
Image	Wireless LAN Info.	
Signal I/O	Wired LAN Info.	
Installation	Network Settings	
Display	Transmitter Settings	
Operation	Reset Network Settings	
Management	Multi-Projection	
Network	Projector ID	Off
Multi-Projection	HDMI Out Setting	Off ▼
Memory	Tiling	
Initial/All Settings	Geometry Correction	Point Correction
	Edge Blending	
	Scale	
	Color Uniformity	
	Light Source Mode	Normal
	Color Matching	
	RGBCMY	
	Reset Multi-Projection Settings	

6. Select **Network Settings** and press **↵ Enter**.
7. Select **Projector Name** and enter a name up to 16 alphanumeric characters long to identify the projector on the network.
8. Set the **Priority Control Interface** setting to **Wireless LAN**.
9. Select the connection method:
 - To connect directly to a wireless device (Simple AP mode), set the **Simple AP** setting to **On** and go to step 17.
 - To connect to a device via a wireless network router (infrastructure mode), set the **Simple AP** setting to **Off** and go to the next step.
 - If you installed the optional wireless LAN module and want to use both connection methods, set the **Simple AP** setting to **On** and go to the next step.

10. Select the **Wireless LAN** menu and press **↵ Enter**.

[Wireless LAN]	Return
Search Access Point	
SSID	
Security	Open
IP Settings	
DNS Server 1	0.0.0.0
DNS Server 2	0.0.0.0
IPv6	Off ▼
IP Address Display	On

11. Select **Search Access Point** and press **↵ Enter**.

The projector searches for wireless networks.

12. Select the network you want to connect to and enter the password, if necessary.

Note: If you need to assign the SSID manually, select **SSID** to enter the SSID. The SSID and password are case-sensitive. Make sure you enter them in the correct case.

13. Select **IP Settings** and press **↵ Enter**.

14. Select your IP settings as necessary:

- If your network assigns addresses automatically, turn on the **DHCP** setting.
- If you must set addresses manually, turn off **DHCP** and enter the projector's **IP Address**, **Subnet Mask**, and **Gateway Address** as needed.

Note: Do not use these addresses: 0.0.0.0, 127.x.x.x, 192.0.2.x or 224.0.0.0 through 255.255.255.255 (where x is a number from 0 to 255) for **IP Address**, 255.255.255.255 or 0.0.0.0 through 254.255.255.255 for **Subnet Mask**, and 0.0.0.0, 127.x.x.x or 224.0.0.0 through 255.255.255.255 for **Gateway Address**. For DNS Server addresses, do not use the following IP

addresses: 127.x.x.x (where x is a number from 0 to 255). When these settings are not set, DNS server information is acquired using DHCP.

Note: To highlight the numbers you want from the displayed keyboard, press the arrow buttons on the remote control. To select a highlighted number, press **↵ Enter**.

15. To prevent display of the IP address on the network information screen, turn off **IP Address Display**.
16. Select **Return** and press **↵ Enter** to return to the Network Settings menu.
17. Select the **Network Projection** menu and press **↵ Enter**.

[Network Projection]		Return
Projector Keyword	Off	
Epson iProjection	On	^
SSID Display	On	
Display LAN Info.	Text & QR Code	
Moderator Password		
Keyword Interrupt Display	Off	
Screen Mirroring	On	^
Interrupt Connection	On	
Adjust Image Quality	1 (Fine)	
HDMI Out Image Output	Off	
Screen Mirroring Info.	On	
Message Broadcasting	Off	
Screen Sharing	On	^
Connection Mode	Keyword On	

18. Turn on the **Projector Keyword** setting if you want to prevent access to the projector by anyone not in the room with it.

Note: The projector displays a random keyword that you must enter from a computer using the Epson iProjection (Windows/Mac) software to access the projector.

19. Set the **Epson iProjection** setting to **On**.
20. Select the following options as necessary:
 - **SSID Display** lets you select whether to display the projector's SSID on the standby screen and Home screen.
 - **Display LAN Info** lets you select how the projector displays network information. You can select an option to display a QR code that lets you quickly connect your iOS or Android devices with the Epson iProjection app.
 - **Moderator Password** lets you enter a password up to 4 numbers long for accessing the projector as a moderator with the Epson iProjection (Windows/Mac) software or the Epson iProjection app.
 - **Keyword Interrupt Display** lets you select whether to display a projector keyword on the projected image when accessing the projector using Epson iProjection.

Note: Use the displayed keyboard to enter the password and keyword. Press the arrow buttons on the remote control to highlight characters and press **↵ Enter** to select them.

21. When you finish selecting settings, select **Return** to return to the **Network Settings** menu.
22. Select **Set** and follow the on-screen instructions to save your settings and exit the menus.

After you complete the wireless settings for your projector, you need to select the wireless network on your computer, or iOS or Android device.

Note: You can press the **LAN** button on the remote control to check your network security settings after completing the wireless settings.

[Wireless LAN Menu Settings](#)

Parent topic: [Wireless Network Projection](#)

Related references

[Network Settings - Network Menu](#)

Wireless LAN Menu Settings

Setting	Options	Description
Search Access Point	To Search View	Search for available wireless network access points in Advanced connection mode

Setting	Options	Description
SSID	Up 32 alphanumeric characters	Manually set the SSID (network name) of the wireless LAN system the projector is connecting to
Security	WPA2/WPA3-PSK WPA2/WPA3-EAP WPA3-PSK WPA3-EAP Open	Selects the type of security used on the wireless network WPA2/WPA3-PSK: uses WPA2/WPA3 personal mode; encryption is dependent on the access point settings; Passphrase must be the same as the access point WPA2/WPA3-EAP: uses WPA2/WPA3 enterprise mode; encryption is dependent on the access point settings WPA3-PSK: uses WPA3 security with AES for encryption. Use the Passphrase value to establish a connection from a computer WPA3-EAP: uses WPA3 enterprise mode; encryption is dependent on the access point settings
Passphrase	Various passphrases from 8 to 63 characters	Selects the pre-shared key used on the network; passphrases are case-sensitive. If the network settings are reset after the passphrase has been changed more than once, the first passphrase is restored. This setting is only displayed when Security is set to WPA3-PSK or WPA2/WPA3-PSK .

Setting	Options	Description
EAP Method	EAP Type User name Password Client Certificate Verify Server Certificate CA certificate RADIUS Server Name	Sets the EAP settings for WPA3-EAP and WPA2/WPA3-EAP security
IP Settings	DHCP (On or Off) IP Address Subnet Mask Gateway Address	Selects DHCP if your network assigns IP addresses automatically, or turns off DHCP so you can enter the network's IP address, subnet mask, and gateway address as needed
DNS Server 1/ DNS Server 2	Various IP addresses	Sets the IP address for the DNS server using 0 to 255 for each address field. The DNS server resolves the host name
IPv6	On Off	Enables IPv6 to allow monitoring and control of the projector over a network using Epson Web Control and PjLink
Auto Configuration	On Off	Selects whether to automatically assign addresses according to the Router Advertisement
Use Temporary Address	On Off	Enables use of a temporary IPv6 address
IP Address Display	On Off	Selects whether to display the IP address on the network standby screen and Home screen

Parent topic: [Selecting Wireless Network Settings Manually](#)

Selecting Wireless Network Settings in Windows

Before connecting to the projector, select the correct wireless network on your computer.

1. To access your wireless utility software, access the Desktop and double-click the network icon on the Windows taskbar.
2. Do one of the following:
 - If your projector is set up on an existing network, select the network name (SSID).
 - If your projector is configured for a direct wireless connection (Simple AP mode), select the projector's SSID.
3. Click **Connect**.

Parent topic: [Wireless Network Projection](#)

Selecting Wireless Network Settings on Mac

Before connecting to the projector, select the correct wireless network on your Mac.

1. Click the AirPort icon on the menu bar at the top of the screen.
2. Make sure AirPort is turned on, then do one of the following:
 - If your projector is set up on an existing network, select the network name (SSID).
 - If your projector is configured for a direct wireless connection (Simple AP mode), select the projector's SSID.

Parent topic: [Wireless Network Projection](#)

Setting Up Wireless Network Security

You can set up security for your projector to use on a wireless network. Set up one of the following security options to match the settings used on your network:

- WPA2-PSK (Simple AP mode only)
- WPA3-PSK
- WPA2/WPA3-PSK
- WPA3-EAP
- WPA2/WPA3-EAP

Note: To set up WPA3-EAP or WAP2/WAP3-EAP security, register your digital certificate file and place it on a USB storage device for connection to your projector.

1. Press the **Menu** button.
2. Select the **Network** menu and press **↵ Enter**.

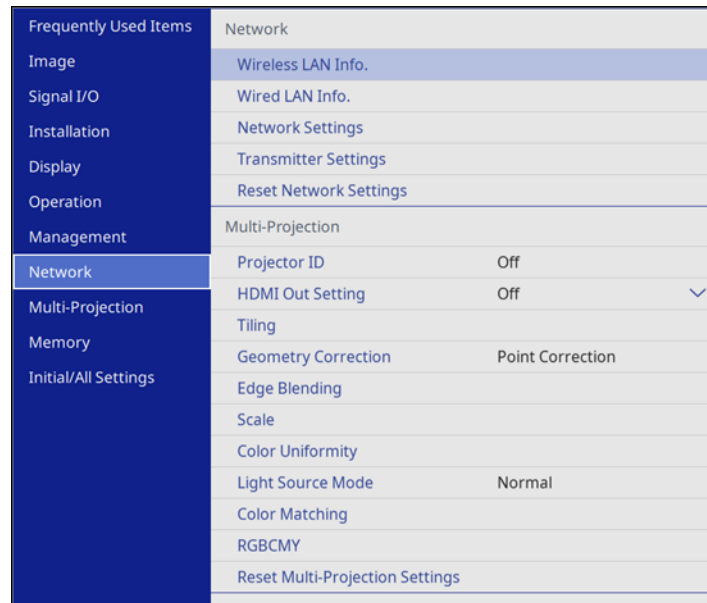

3. Select **Network Settings** and press **↵ Enter**.
4. Do one of the following:
 - To connect directly to a wireless device (Simple AP mode), select **Passphrase**, press **↵ Enter**, and enter a passphrase from 8 to 63 characters long. When you are done, return to the **Network Settings** screen, select **Set**, and follow the on-screen instructions to save your settings and exit the menus. Skip the rest of these steps.
 - To connect to a device via a wireless network router (infrastructure mode), select the **Wireless LAN** menu and press **↵ Enter**. Continue with the next step.
5. Select the **Security** setting and press **↵ Enter**.
6. Select the security settings for your network.
7. Do one of the following according to the security you selected:
 - **WPA3-PSK** or **WPA2/WPA3-PSK**: Select **Passphrase**, press **Enter**, and enter a passphrase from 8 to 63 characters long. Then continue with step 9.

- **WPA3-EAP** or **WPA2/WPA3-EAP**: Select **EAP Type** and press **Enter**.
8. Select the protocol for authentication as the **EAP Type** setting.
 9. To import your certificate, select the certificate type and press **↵ Enter**.
 - **Client Certificate** for **PEAP-TLS** or **EAP-TLS**
 - **CA Certificate** for all EAP types
 10. Select **Save** and press **↵ Enter**.
 11. Follow the on-screen instructions to connect a USB storage device to the projector's **USB-A** port.
 12. Press **↵ Enter** to display the certificate list.
 13. Select the certificate to import.
 14. Enter a password for the certificate and press **↵ Enter**.

The certificate is imported and a completion message appears.
 15. Select your EAP settings as necessary.
 - **User Name** lets you enter a user name using up to 64 alphanumeric characters. When importing a client certificate, this is automatically set based on the certificate information.
 - **Password** lets you enter a password using up to 64 alphanumeric characters for authentication when using the PEAP or EAP-FAST type.
 - **Verify Server Certificate** lets you select whether or not to verify the server certificate when a CA certificate has been set.
 - **RADIUS Server Name** lets you enter the server name to be verified.
 16. When you are finished, select **Return** and press **↵ Enter** to return to the **Network Settings** menu.
 17. Select **Set**, and follow the on-screen instructions to save your settings and exit the menus.

Parent topic: [Wireless Network Projection](#)

Related tasks

[Registering Digital Certificates from a Web Browser](#)

Using a QR Code to Connect a Mobile Device

After you select the wireless network settings for your projector, you can display a QR code on the screen and use it to connect a mobile device using the Epson iProjection app.

Note: Make sure you have installed the latest version of Epson iProjection on your device. Visit epson.com/iprojection (U.S.), epson.ca/iprojection (Canada), or latin.epson.com/iprojection (Caribbean) for more information.

If you are using Epson iProjection in Quick connection mode, it is recommended that you enable wireless security, such as a moderator password.

In order to use the QR code feature, the **Connection Guide Display** setting in the **Network > Transmitter Settings** menu must be disabled.

1. Press the **LAN** button on the remote control.
Your projector displays the QR code on the projection surface.

Note: If you do not see the QR code after pressing the **LAN** button, press **Enter** to display it.

2. Start Epson iProjection on your mobile device.
3. Use the QR code reader feature to read the QR code and connect your device to the projector. Visit epson.com/iprojection (U.S.), epson.ca/iprojection (Canada), or latin.epson.com/iprojection (Caribbean) for instructions.

If you do not see the QR code, press the **Menu** button on the remote control and select the **Network > Network Settings > Network Projection > Epson iProjection** menu. Set the **Display LAN Info.** setting to **Text & QR Code.**

Parent topic: [Wireless Network Projection](#)

Related references

[Network Settings - Network Menu](#)

Wireless Network Projection from a Mobile Device or Windows Computer (Screen Mirroring)

You can send images to your projector from mobile devices such as laptops, smartphones, and tablets using Miracast technology or from a Windows computer. If your device supports Miracast, you do not need to install any additional software. When using a Windows computer, make sure the necessary adapter for the Miracast connection is available.

You can connect two devices simultaneously using Miracast. The projector detects the input sources as Screen Mirroring1 and Screen Mirroring2. Set **Interrupt Connection** to **Off**.

[Screen Mirroring Restrictions](#)

[Selecting Screen Mirroring Settings](#)

[Connecting for Screen Mirroring with Miracast](#)

[Connecting for Screen Mirroring with a Windows 8.x/Windows 10 Computer](#)

Parent topic: [Wireless Network Projection](#)

Screen Mirroring Restrictions

Note the following when using Screen Mirroring features:

- You cannot project an interlaced image.
- You cannot play audio with more than 3 channels.
- You may not be able to project images depending on the resolution and frame rate.
- You cannot project 3D video.
- You cannot use extended Miracast features on Windows 8.1.
- You may not be able to view contents with copyright protection using a Miracast connection.
- Do not change the projector's Screen Mirroring settings during Screen Mirroring projection. Doing so may cause the projector to disconnect and delay reconnection.
- Do not turn off the electrical supply to the projector during Screen Mirroring projection.

Parent topic: [Wireless Network Projection from a Mobile Device or Windows Computer \(Screen Mirroring\)](#)

Selecting Screen Mirroring Settings

You can select Screen Mirroring settings for your projector and then project images from your mobile device.

1. Press the **Menu** button.

2. Select the **Management** menu and press **↵ Enter**.

Frequently Used Items	Management	
Image	User Button	Light Source Mode
Signal I/O	User's Logo	
Installation	Control Panel Lock	Off
Display	Color Uniformity	
Operation	Refresh Mode	
Management	Light Source Calibration	
Network	Date & Time	
Multi-Projection	Schedule Settings	
Memory	Wireless LAN Power	
Initial/All Settings	Wireless LAN Diagnosis	1
	Log Save Destination	USB and Internal Memory
	Batch Setup Range	
	Language 🌐	English
	Information	
	Display Logs	
	Reset Management Settings	
	Network	

3. Set the **Wireless LAN Power** setting to **On**.

4. Select the **Network** menu and press **↵ Enter**.

Frequently Used Items	Network	
Image	Wireless LAN Info.	
Signal I/O	Wired LAN Info.	
Installation	Network Settings	
Display	Transmitter Settings	
Operation	Reset Network Settings	
Management	Multi-Projection	
Network	Projector ID	Off
Multi-Projection	HDMI Out Setting	Off ▼
Memory	Tiling	
Initial/All Settings	Geometry Correction	Point Correction
	Edge Blending	
	Scale	
	Color Uniformity	
	Light Source Mode	Normal
	Color Matching	
	RGBCMY	
	Reset Multi-Projection Settings	

5. Select **Network Settings** and press **↵ Enter**.
6. Select **Priority Control Interface** and press **↵ Enter**.
7. Choose one of the following options:
 - If you are casting images over a wired LAN, select **Wired LAN**.
 - If you are casting images wirelessly directly or via a wireless network router, select **Wireless LAN**.
8. Set the **Simple AP** setting to **On**.
9. Select **Network Projection** and press **↵ Enter**.
10. Set the **Screen Mirroring** setting to **On**.
11. Select these settings as necessary:
 - **Interrupt Connection** lets you connect another mobile device while projecting using Screen Mirroring or to exclusively connect to one device. If you want to use two Screen Mirroring sources, turn this setting off.

- **Adjust Image Quality** lets you adjust the screen mirroring speed and quality. Select a small number to improve the quality or a large number to increase the speed.
 - **HDMI Out Image Output** lets you output the Screen Mirroring image to the **HDMI Out** port (not available on the PowerLite EB-L520U). HDCP and H.265 features are disabled and you may not be able to project protected content. If you want to project content with HDCP and H.265 features, select **Off**.
 - **Screen Mirroring Info** displays connection information when projecting from a Screen Mirroring source.
12. When you finish selecting settings, select **Return** and press **↩ Enter** to return to the **Network Settings** screen.
 13. Select **Set**, and follow the on-screen instructions to save your settings and exit the menus.

Parent topic: [Wireless Network Projection from a Mobile Device or Windows Computer \(Screen Mirroring\)](#)

Related references

[Administration Settings - Management Menu](#)

[Network Settings - Network Menu](#)

Connecting for Screen Mirroring with Miracast

If your mobile device supports Miracast, you can connect it to the projector wirelessly and project images and sound.

1. Select the Screen Mirroring settings on your projector as necessary.
2. Press the **LAN** button on the remote control to switch to the Screen Mirroring source.
You see the Screen Mirroring standby screen.
3. On your mobile device, use the Miracast function to search for the projector.

Note: See your mobile device's documentation for information on accessing the Miracast function.

You see a list of available devices.

4. Select your projector from the list.
5. If you see the PIN entry screen on your mobile device, enter the PIN code displayed on the Screen Mirroring standby screen or at the bottom right of the projected image.

The projector displays the image from your mobile device.

Caution: It may take some time to establish the connection. Do not disconnect the projector's power cord while it is connecting to your device. Doing so may cause your device to freeze or malfunction.

Note: Depending on the mobile device, you may need to delete a device when connecting. Follow the on-screen instructions on your device.

Parent topic: [Wireless Network Projection from a Mobile Device or Windows Computer \(Screen Mirroring\)](#)

Related tasks

[Selecting Screen Mirroring Settings](#)

Connecting for Screen Mirroring with a Windows 8.x/Windows 10 Computer

You can set up your computer to wirelessly project images and play sound using Screen Mirroring.

Note: If you are using Windows 10, you can cast images over a local area network or from your device to the projector directly. When you cast images over a local area network, the connection is more stable and secure. Connect the projector to the network with an Ethernet cable or install the optional wireless LAN module and set the wireless LAN settings to connect to a wireless network.

1. Select the Screen Mirroring settings on your projector as necessary.
2. Press the **LAN** button on the remote control to switch to the Screen Mirroring source.
You see the Screen Mirroring standby screen.
3. Do one of the following:
 - **Windows 10:** Open **Action Center** and select **Connect**.
 - **Windows 8.x:** Select **Devices > Project > Add a wireless display**.
4. Select your projector's Display Name from the list.
5. If you see the PIN entry screen on your computer, enter the PIN code displayed on the Screen Mirroring standby screen or at the bottom right of the projected image.
The projector displays the image from your computer or mobile device.

Note: It may take some time to establish the connection. Do not disconnect the projector's power cord while it is connecting to your device. This may cause your device to freeze or malfunction.

Parent topic: [Wireless Network Projection from a Mobile Device or Windows Computer \(Screen Mirroring\)](#)

Related tasks

[Selecting Screen Mirroring Settings](#)

Screen Sharing

You can share the projected screen to up to four other compatible Epson projectors connected to the same network with the screen sharing function.

The screen sharing function is limited by the following:

- You can only share the projected screen to other projectors with the screen sharing capability.
- If your projector's firmware version is older than the version installed on other projectors on the network, you may not be able to project your screen or display a shared screen and may need to update your projector's firmware.
- You cannot share images that are protected by HDCP.
- You cannot change the projector's **Network** settings while sharing your screen or displaying a shared screen.

[Sharing Your Screen](#)

[Projecting Screen Sharing Images](#)

Parent topic: [Using the Projector on a Network](#)

Related concepts

[Updating the Firmware](#)

Sharing Your Screen

You can share your projected image to up to four projectors connected to the same network.

Before sharing your screen, make sure the **Screen Sharing** setting is enabled.

Note: Make sure your projector is not connected to any devices via Epson iProjection before you use the screen sharing function.

1. Turn on the projector.
2. Connect your projector to the same network as the host projector that is sharing its screen.

3. Press the **Home** button on the projector or the remote control.

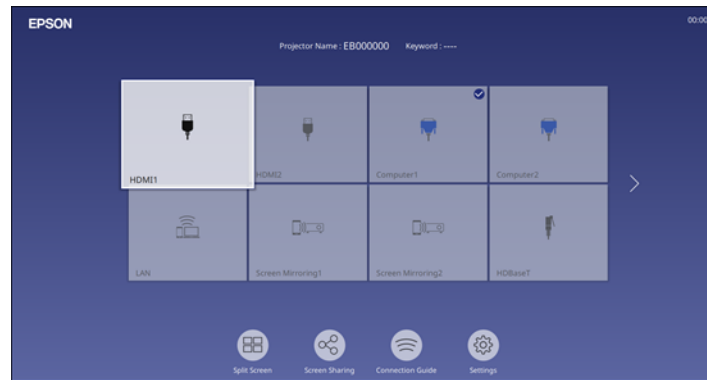

4. Select **Screen Sharing**.
 5. Select **Start Screen Sharing**.
 6. Select the projector you want to share your screen with using one of the following methods:
 - Enter the IP address of the projector using the numeric keypad.
 - Enter the projector keyword using the numeric keypad, if required. The projector keyword is displayed on the projected image of the receiving projector.
 - Choose a previously selected projector by selecting an IP address from the connection history list.
 7. Select **Connect**.
- The connection is established and you see the Home screen. A status bar indicating the sharing status appears on the screen.
8. Repeat steps 6 and 7 to add additional projectors as necessary.
 9. When you are finished, select the input source from which to project images.

If you press the **Esc** button to stop sharing your screen, all connected projectors are disconnected. To disconnect a specific projector, press the **Home** button and select **Screen Sharing**, then select the projector you want to disconnect and select the icon next to the IP address.

Note: If you want to skip authenticating keywords for other projectors to speed up the connection process, set the **Network > Network Settings > Network Projection > Screen Sharing > Connection Mode** setting to **Keyword Off**.

Parent topic: [Screen Sharing](#)

Related references

[Network Settings - Network Menu](#)

Projecting Screen Sharing Images

You can display shared images from other projectors that have the Screen Sharing feature. All projectors must be connected to the same network.

Note: Make sure your projector is not connected to any devices via Epson iProjection before you use the screen sharing function.

1. Turn on the projector.
2. Connect your projector to the same network as the host projector that is sharing its screen.
3. Press the **Menu** button on the projector or the remote control.
4. Select the **Network** menu and press **↵ Enter**.

Frequently Used Items	Network	
Image	Wireless LAN Info.	
Signal I/O	Wired LAN Info.	
Installation	Network Settings	
Display	Transmitter Settings	
Operation	Reset Network Settings	
Management	Multi-Projection	
Network	Projector ID	Off
Multi-Projection	HDMI Out Setting	Off
Memory	Tiling	
Initial/All Settings	Geometry Correction	Point Correction
	Edge Blending	
	Scale	
	Color Uniformity	
	Light Source Mode	Normal
	Color Matching	
	RGBCMY	
	Reset Multi-Projection Settings	

5. Select **Network Settings** and press **↵ Enter**.

6. Select **Network Projection** and press **↵ Enter**.
7. Set the **Screen Sharing** setting to **On**.
8. When you finish selecting settings, select **Return** and press **↵ Enter** to return the **Network Settings** menu.
9. Select **Set**, and follow the on-screen instructions to save your settings and exit the menus.

When a projector on the same network shares its screen, the shared screen is automatically displayed on your projector. If it isn't, press the **LAN** button on the remote control to switch to the screen sharing source. To exit screen sharing, press the **Esc** button on the remote control.

Parent topic: [Screen Sharing](#)

Related references

[Network Settings - Network Menu](#)

Setting Up Projector Network E-Mail Alerts

You can set up the projector to send you an e-mail alert over the network if there is a problem with the projector.

Note: If the **Standby Mode** setting is set to **Communication On** in the **Operation** menu, you can receive e-mail alerts even if the projector is in standby mode (the power is off). The **Standby Mode** setting is displayed only if the **A/V Output** setting in the Signal I/O menu is set to **While Projecting**.

1. Press the **Menu** button.

2. Select the **Network** menu and press **↵ Enter**.

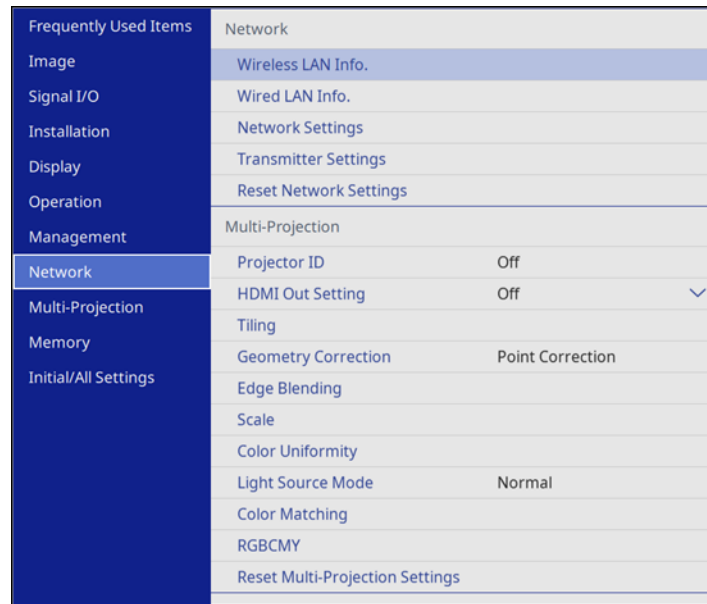

3. Select **Network Settings** and press **↵ Enter**.
4. Select the **Mail Notification** menu and press **↵ Enter**.

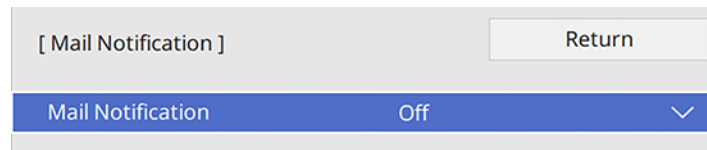

5. Turn on **Mail Notification**.
6. Enter the IP address for the **SMTP Server** setting.
Note: Do not use 127.x.x.x (where x is a number from 0 to 255).
7. Select a type of **Authentication** for the SMTP server.

8. Select a number for the SMTP server **Port Number** setting, from 0 to 65535 (default is 25).
9. Enter a **User Name** for the SMTP server.
10. Enter a **Password** for the SMTP server authentication.
11. Enter the sender's email address as the **From** setting.
12. Choose an **Address** field, enter the e-mail address, and select the alerts you want to receive there. Repeat for up to three addresses. Your e-mail address can be up to 64 alphanumeric characters long.
13. If you are using the PJLink protocol for projector control, turn on the **PJLink** setting in the Projector Control menu and enter the IP address where you want to receive PJLink notifications as the **Notified IP Address** setting.
14. When you finish selecting settings, select **Return** and press **↵ Enter** to return to the **Network Settings** menu.
15. Select **Set**, and follow the on-screen instructions to save your settings and exit the menus.

Note: If a critical problem causes a projector to shut down, you may not receive an e-mail alert.

[Network Projector E-mail Alert Messages](#)

Parent topic: [Using the Projector on a Network](#)

Related references

[Feature Settings - Operation Menu](#)

Network Projector E-mail Alert Messages

When a problem occurs with a networked projector, and you selected to receive e-mail alerts, you receive an e-mail containing the following information:

- The email address entered as the **From** setting
- **Epson Projector** on the subject line
- The name of the projector experiencing a problem
- The IP address of the affected projector
- Detailed information about the problem

Note: If a critical problem causes a projector to shut down, you may not receive an e-mail alert.

Parent topic: [Setting Up Projector Network E-Mail Alerts](#)

Setting Up Monitoring Using SNMP

Network administrators can install SNMP (Simple Network Management Protocol) software on network computers so they can monitor projectors. If your network uses this software, you can set up the projector for SNMP monitoring.

1. Press the **Menu** button.
2. Select **Network > Network Settings > Projector Control > SNMP > On**.
3. Enter up to two IP addresses to receive SNMP notifications as the **Trap IP Address** setting, using 0 to 255 for each address field.

Note: To enter the IP address using the numeric keys on the remote control, press and hold the **Num** button. Do not use these addresses: 224.0.0.0 through 255.255.255.255. This projector supports SNMP agent version 1 (SNMPv1).

4. Enter the SNMP **Community Name** (up to 32 alphanumeric characters).
5. When you finish selecting settings, select **Return** and press **↵ Enter** to return to the **Network Settings** menu.
6. Select **Set**, and follow the on-screen instructions to save your settings and exit the menus.

Parent topic: [Using the Projector on a Network](#)

Related references

[Network Settings - Network Menu](#)

Controlling a Networked Projector Using a Web Browser

Once you have connected your projector to your network, you can select projector settings and control projection using a compatible web browser. This lets you access the projector remotely. You can also control the projector using a web browser through the Epson iProjection app on iOS or Android.

Note: The web setup and control features support Microsoft Internet Explorer 11.0 or later (Windows), Microsoft Edge (Windows), Safari (Mac), and Chrome (Android) on networks that do not use a proxy server for connection. You cannot select all of the projector menu settings or control all projector functions using a web browser.

1. Make sure the projector is turned on.
2. Start your web browser on a computer or device connected to the network.

3. Type the projector's IP address into the browser's address box and press the computer's **Enter** key.

Note: You may need to log in to access some of the options on the Web Control screen. If you see a log in window, enter your user name and password. (For the Basic Control option, the default user name is **EPSONREMOTE** and the default password is **guest**. For all other options, the default password is **EPSONWEB** and the default password is **admin**.)

You see the Epson Web Control screen.

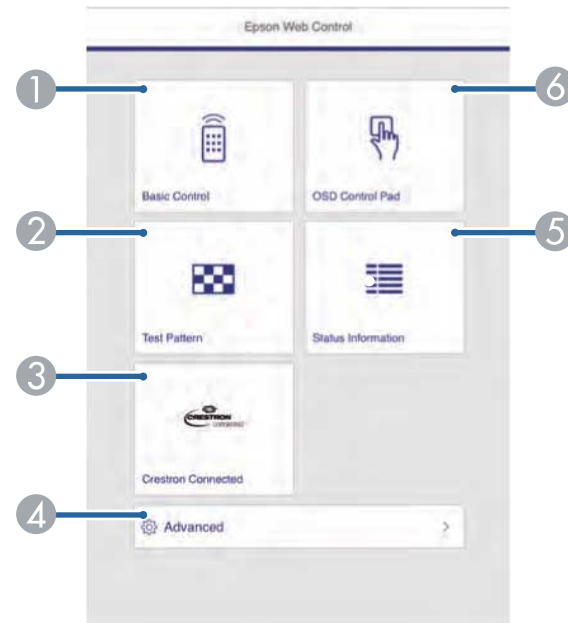

- 1 Select **Basic Control** to control the projector remotely.
- 2 Select **Test Pattern** to display a test pattern
- 3 Select **Crestron Connected** to open the menu
- 4 Select **Advanced** to open the advanced menu screen.
- 5 Select **Status Information** to view the projector's status.
- 6 Select **OSD Control Pad** to change the projector's menu settings.

4. Select the option corresponding to the projector function you want to control.

[Web Control Options](#)

Parent topic: [Using the Projector on a Network](#)

Web Control Options

Basic Control

Note: If the Remote Password is set to **On**, you need to enter your user name and password. (The default username is **EPSONREMOTE** and the default password is **guest**).

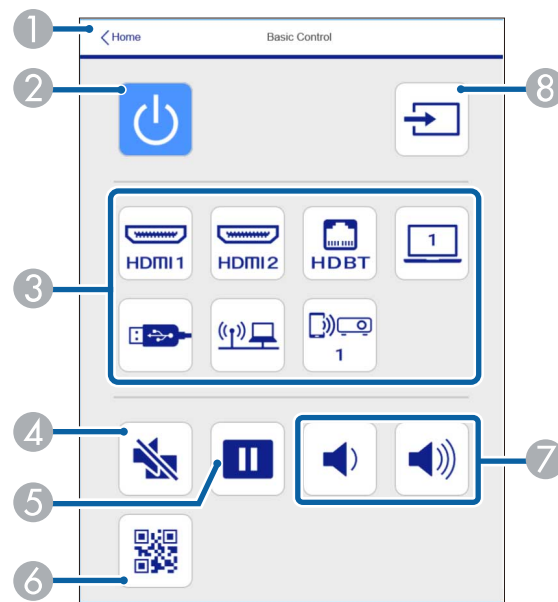

- 1 Returns to the Home screen
- 2 Turns the projector on or off
- 3 Input source selection controls
- 4 **A/V Mute** button control
- 5 Pauses or resumes images

- 6 Displays the QR code
- 7 **Volume** button controls
- 8 Searches for sources

OSD Control Pad

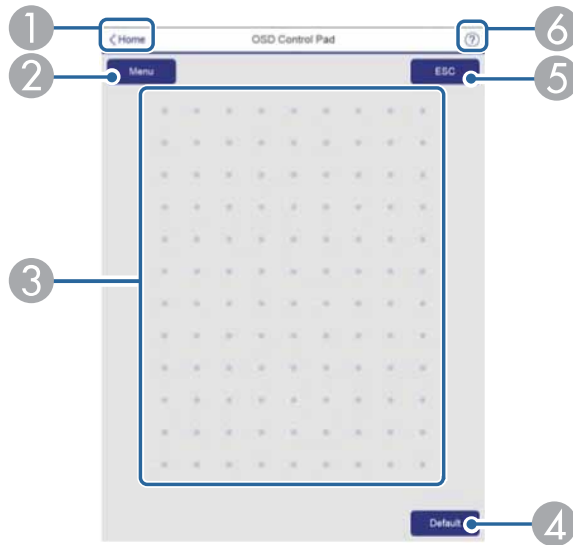

- 1 Returns to the Epson Web Control screen
- 2 Displays the projector's setting menu
- 3 Use your finger or mouse to navigate the menus
- 4 Returns projector to default settings
- 5 Returns to the previous menu
- 6 Displays help topics

Note: You cannot change some settings using Epson Web Control.

Test Pattern screen

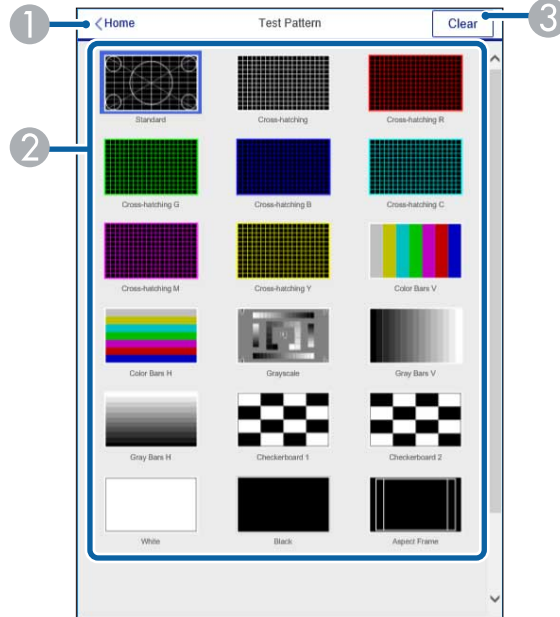

- 1 Returns to the Home screen
- 2 Displays available test patterns; select to project a test pattern
- 3 Turns off test pattern display

Status Information screen

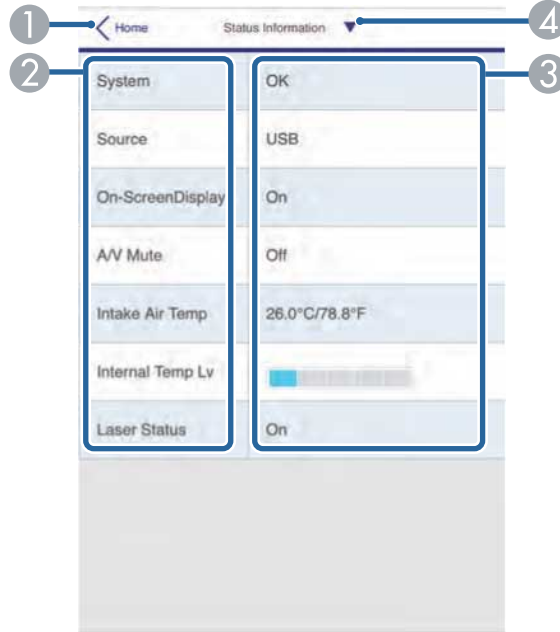

- 1 Returns to the Home screen
- 2 Displays a list of monitored settings
- 3 Displays the setting status
- 4 Select to view different status information

Advanced

If the default **Web Control Password** is set, a screen prompting you to change the password appears before you can view the **Advanced** screen. It is strongly recommended that you change the password regularly to prevent unauthorized access to your projector.

Note: Not all settings can be changed through Web Control. The following settings can only be set using Web Control:

- Monitor Password (up to 16 alphanumeric characters)

- IPv6 Settings (manual)
- HTTP port (used for Web Control; cannot use 80 [default], 843, 3620, 3621, 3625, 3629, 4352, 4649, 5357, 10000, 10001, or 41794)

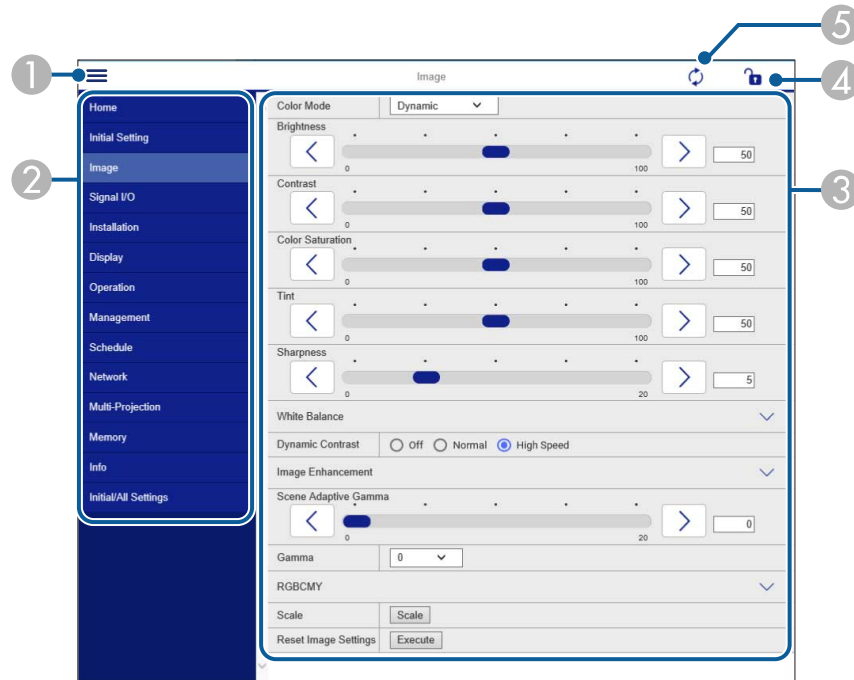

- 1 Opens the menus
- 2 Displays the selected menu name
- 3 Contains the selected projector settings
- 4 Locks or unlocks the projector settings
- 5 Updates the projector settings

Parent topic: [Controlling a Networked Projector Using a Web Browser](#)

Controlling a Networked Projector in Content Playback Mode

When Content Playback mode is turned on in the Settings menu, you can select projector settings, control projection, and edit playlists using a web browser.

Note: You can also control the projector using a web browser through the Epson iProjection app.

Note: Do not remove any USB device connected to the projector or unplug the power cord when the Playlists or USB Memory Device screen is displayed; data saved on the USB device may be damaged.

1. Make sure the projector is turned on and your computer or device is connected to the same network as the projector.
2. Start your web browser on the computer or device.
3. Type the projector's IP address into the browser's address box and press the computer's **Enter** key.
You see the Epson Web Control screen.

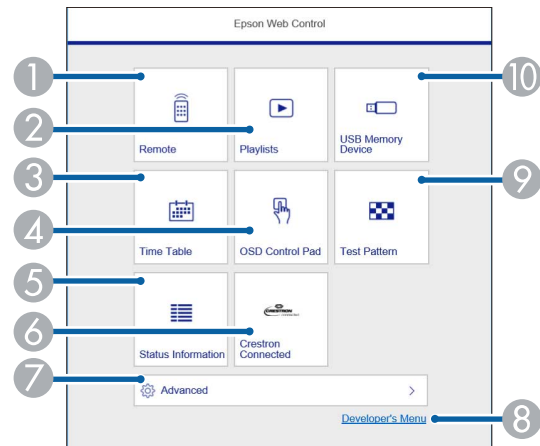

- 1 Controls the projector remotely
- 2 Edits playlists for Content Playback mode
- 3 Opens the Time Table screen
- 4 Operates the projector's menus with your finger or a mouse
- 5 Displays the projector's status

- 6 Opens the Crestron Connected window (available when Crestron Connected is turned on)
 - 7 Opens detailed projector settings
 - 8 Opens the Developer's Menu screen
 - 9 Displays a test pattern
 - 10 Registers or deletes playlist data on the USB device
4. Select the option corresponding to the projector function you want to control.

Note: You may need to log in to access some of the options on the Web Control screen. If you see a log in window, enter your user name and password. (The default user name is **EPSONWEB** and the default password is **admin**.)

[Web Control Options in Content Playback Mode](#)

Parent topic: [Using the Projector on a Network](#)

Web Control Options in Content Playback Mode

Remote

Note: If the Remote Password is set to **On**, you need to enter your user name and password. (The default username is **EPSONREMOTE** and the default password is **guest**).

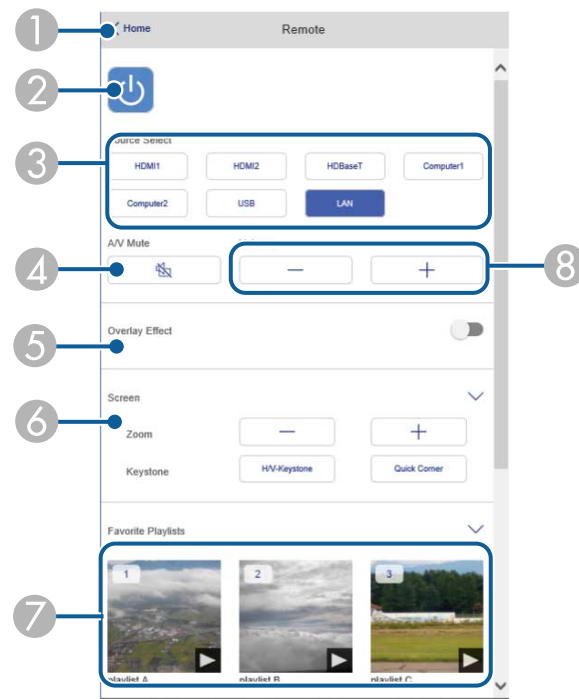

- 1 Returns to the Epson Web Control screen
- 2 Turns the projector on or off
- 3 Selects the input source
- 4 **A/V Mute** button control
- 5 Turns **Overlay Effect** on or off
- 6 Displays the screen settings

- 7 Selects your favorite playlists
- 8 Adjusts the speaker volume

Playlists

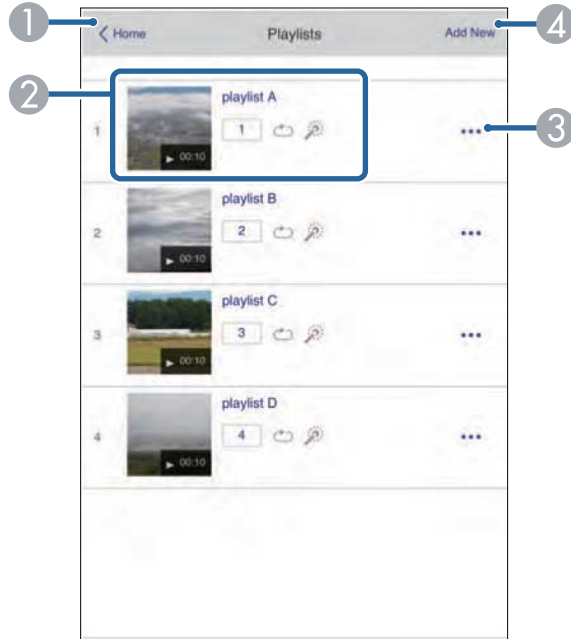

- 1 Returns to the Epson Web Control screen
- 2 Controls playback of the playlist
- 3 Edits, copies, or deletes the playlist
- 4 Creates a new playlist

Create or Edit Playlist

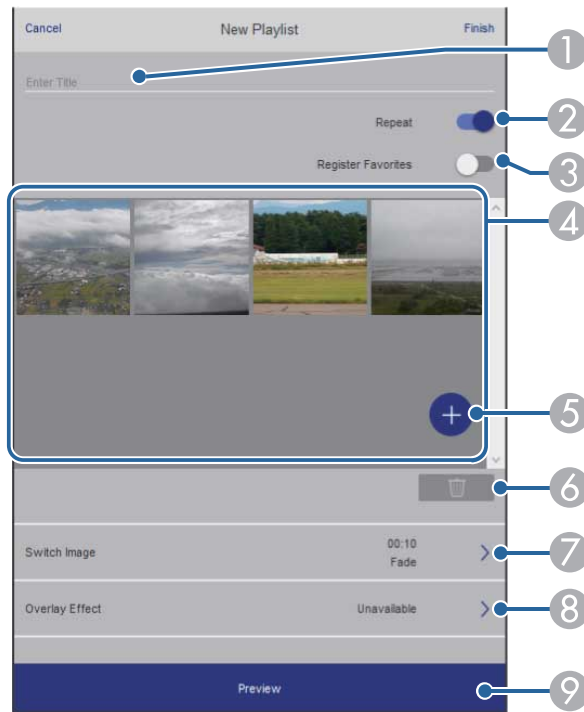

- 1 Edits the playlist name
- 2 Enables repeat playback
- 3 Adds the playlist to your favorites list
- 4 Displays the images or movies in the order that they will be played
- 5 Adds items to the playlist
- 6 Deletes items from the playlist
- 7 Opens the Switch Image screen (specifies the time before the projector switches to the next item in the playlist)
- 8 Opens the Effects screen
- 9 Previews the playlist

USB Memory Device

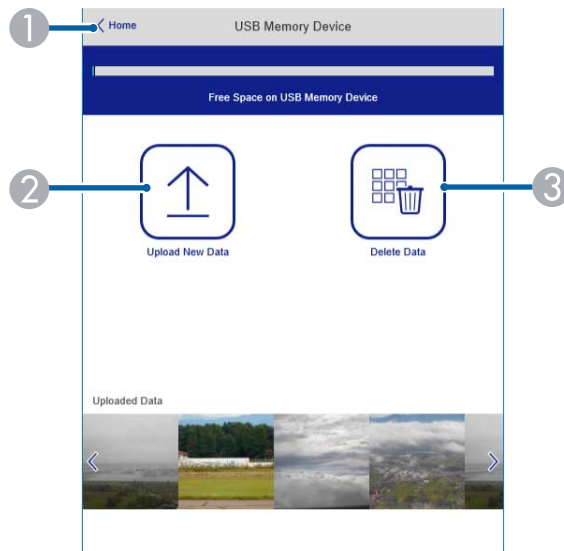

- 1 Returns to the Epson Web Control screen
- 2 Uploads images or videos to add to playlists on a USB device
- 3 Deletes images or videos on the USB device

Note: You can upload .avi, .jpeg (.jpg), .png, .bmp, or .gif files using Epson Web Control. If you want to add .mp4 or .mov files to the playlist, use the Epson Projector Content Manager software or the Epson Creative Projection app.

Time Table



- 1 Returns to the Epson Web Control screen
- 2 Turns the time table on or off (see the *Epson Projector Content Manager Operation Guide* for more information)

OSD Control Pad

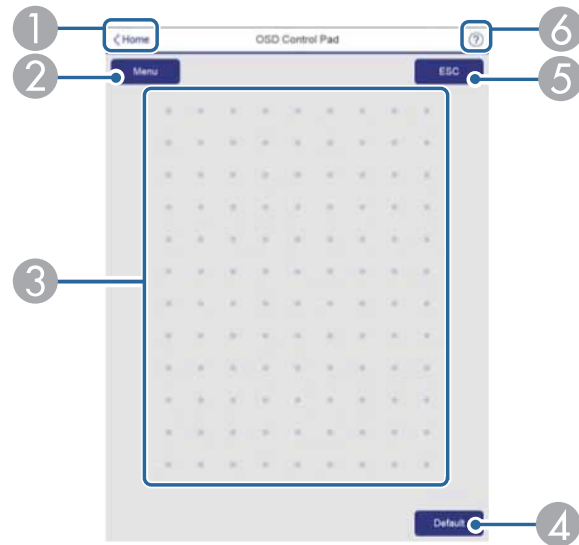

- 1 Returns to the Epson Web Control screen
- 2 Displays the projector's setting menus
- 3 Use your finger or mouse to navigate the menus
- 4 Returns projector to default settings
- 5 Returns to the previous menu
- 6 Displays help topics

Note: You cannot change some settings using Epson Web Control.

Parent topic: [Controlling a Networked Projector in Content Playback Mode](#)

Using Crestron Connected

If you are using the Crestron Connected network monitoring and control system, you can set up your projector for use on the system. Crestron Connected lets you control and monitor your projector using a web browser.

Note: You cannot use the Message Broadcasting feature in the Epson Projector Management software when you use Crestron Connected.

For additional information on Crestron Connected, contact Crestron.

[Setting Up Crestron Connected](#)

[Controlling a Networked Projector Using Crestron Connected](#)

Parent topic: [Using the Projector on a Network](#)

Setting Up Crestron Connected

To set up your projector for monitoring and control using a Crestron Connected system, make sure your computer and projector are connected to the network.

Note: If you want to use the Crestron Connected system when the projector is turned off, you need to adjust the **Standby Mode** setting in the Operation menu. The **Standby Mode** setting is displayed only if the **A/V Output** setting in the Signal I/O menu is set to **While Projecting**.

1. Press the **Menu** button.
2. Select the **Network** menu and press **↵ Enter**.

Frequently Used Items	Network	
Image	Wireless LAN Info.	
Signal I/O	Wired LAN Info.	
Installation	Network Settings	
Display	Transmitter Settings	
Operation	Reset Network Settings	
Management	Multi-Projection	
Network	Projector ID	Off
Multi-Projection	HDMI Out Setting	Off
Memory	Tiling	
Initial/All Settings	Geometry Correction	Point Correction
	Edge Blending	
	Scale	
	Color Uniformity	
	Light Source Mode	Normal
	Color Matching	
	RGBCMY	
	Reset Multi-Projection Settings	

3. Select **Network Settings** and press **↵ Enter**.
4. Select the **Projector Control** menu and press **↵ Enter**.

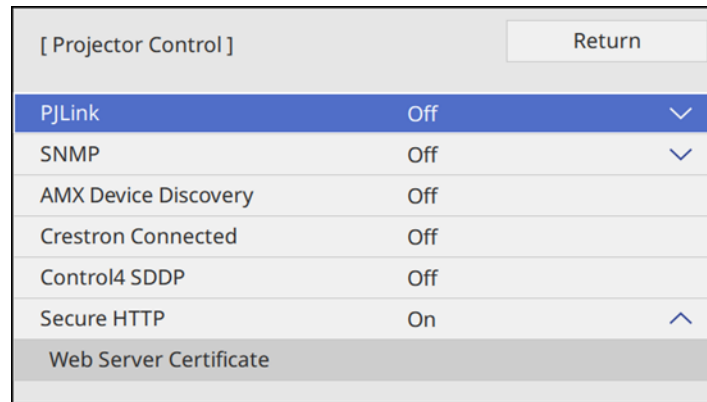

[Projector Control]		Return
PJLink	Off	▼
SNMP	Off	▼
AMX Device Discovery	Off	
Crestron Connected	Off	
Control4 SDDP	Off	
Secure HTTP	On	▲
Web Server Certificate		

5. Set the **Crestron Connected** setting to **On** to allow the projector to be detected.

Note: Enabling Crestron Connected disables the Message Broadcasting feature in the Epson Projector Management software.

6. When you are finished selecting settings, select **Return** and press **↵ Enter** to return to the **Network Settings** menu.
7. Select **Set**, and follow the on-screen instructions to save your settings and exit the menus.
8. Start your Web browser on a computer or device connected to the network.
9. Go to the **Epson Web Control** screen by entering the projector's IP address into the browser's address box.
10. Select the **Crestron Connected** settings. See the Crestron Web site for details.

Parent topic: [Using Crestron Connected](#)

Related references

[Input Signal Settings - Signal I/O Menu](#)

[Feature Settings - Operation Menu](#)

[Network Settings - Network Menu](#)

Controlling a Networked Projector Using Crestron Connected

Once you have set up your projector to use Crestron Connected, you can control and monitor projection using a compatible web browser.

1. Start your web browser on a computer connected to the network.
2. Type the projector's IP address into the browser's address box and press the computer's **Enter** key.

You see the Epson Web Control screen:

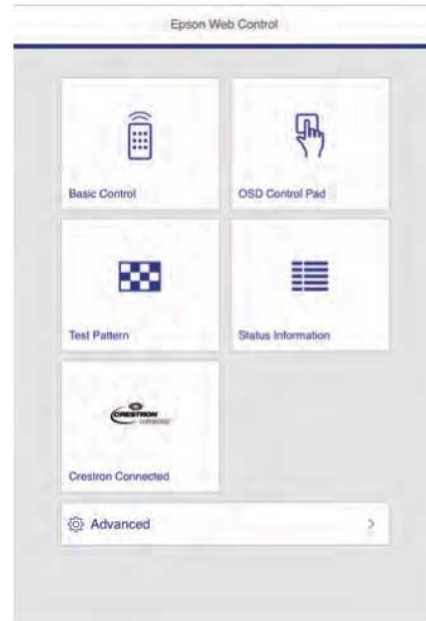

Note: You may need to log in to access some of the options on the Web Control screen. If you see a log in window, enter your user name and password. (The default user name is **EPSONWEB** and the default password is **admin**.)

3. Select **Crestron Connected**.
4. When you finish selecting settings, select **Set** and then select **Yes** to save the network settings.

Parent topic: [Using Crestron Connected](#)

Related tasks

[Controlling a Networked Projector Using a Web Browser](#)

Setting Up Web API

You can setup Web API from a Web browser and operate the projector using Web API.

Note: You can authenticate Web API communications using API authentication (Digest authentication). The user name for API authentication is **EPSONWEB**; use the password that is set for **Web Control Password**.

1. Open the Epson Web Control from your Web browser.
2. Select **Developer's Menu**.
3. Set the **Enable API** setting to **On**.
4. Enter one of the following Web APIs to operate the projector:

URL	Supported methods	Description
http://<ip>/api/v01/contentmgr/remote/power/on	GET/POST/PUT	Turns the projector on (WebAPI may not respond immediately)
http://<ip>/api/v01/contentmgr/remote/power/off		0 to 63 (default is 128)
http://<ip>/api/v01/contentmgr/playlist/play/:id		0 to 7 (default is 0)
http://<ip>/api/v01/contentmgr/playlist/stop		0 to 31 (default is 128)

Note: In the above URLs, enter the IP address for the projector in the <ip> field. For example, a URL instructing a projector with the IP address 192.168.0.2 to playback playlist ID 3 would look like this:
http://192.168.0.2/api/v01/contentmgr/playlist/play/3

If secure HTTP is enabled, change the http in the URL to https.

Parent topic: [Using the Projector on a Network](#)

Secure HTTP

You can use the HTTPS protocol to increase security between the projector and a web browser communicating with it. To do this, you create a server certificate, install it on the projector, and turn on the **Secure HTTP** setting in the projector menus to verify the reliability of the web browser.

Even if you do not install a server certificate, the projector automatically creates a self-signed certificate and allows communication. However, because the self-signed certificate cannot verify reliability from a web browser, you see a warning about the server's reliability when you access the projector from a web browser. This warning does not prevent communication.

[Importing a Web Server Certificate Using the Projector Menus](#)

Parent topic: [Using the Projector on a Network](#)

Importing a Web Server Certificate Using the Projector Menus

You can create your web server certificate and import it using the projector menus and a USB flash drive.

Note: You can also register digital certificates from your web browser. Make sure to only register once, or the certificate may not install correctly.

1. Make sure your digital certificate file is compatible with projector registration and saved in the root directory of the USB flash drive.
2. Press the **Menu** button on the projector or remote control.
3. Select **Network > Network Settings > Projector Control > Secure HTTP > On**.
4. Select the **Web Server Certificate** setting and press **↵ Enter**.
5. Select **Save** and press **↵ Enter**.
6. Follow the on-screen instructions to connect a USB flash drive to the **USB-A** port on the projector.
7. Press **↵ Enter** to display the certificate list.
8. Select the certificate you want to import from the displayed list.
A message is displayed prompting you to enter the password for the certificate.
9. Enter the password and press **↵ Enter**.

The certificate is imported and a completion message appears.

Parent topic: [Secure HTTP](#)

Related references

[Network Settings - Network Menu](#)

Registering a Digital Certificate on the Projector

Follow the instructions here if you need to install a digital certificate on the projector to provide security for your presentation files.

Note: You can register a digital certificate using a web browser or through the projector's Network menu. However, be sure to register just once, or the certificate may not install correctly.

[Registering Digital Certificates from a Web Browser](#)

[Digital Certificate Types](#)

Parent topic: [Using the Projector on a Network](#)

Registering Digital Certificates from a Web Browser

You can register the digital certificates on the projector for wireless LAN authentication.

1. Make sure your digital certificate file is compatible with projector registration.
2. Make sure the projector is turned on.
3. Start your web browser on a computer or mobile device connected to the network.
4. Type the projector's IP address into the browser's address box and press the computer's **Enter** key.
You see the Web Control screen and a prompt to enter a user ID and password.
5. Enter the following information in uppercase or lowercase letters, exactly as shown:
 - For the user ID, enter **EPSONWEB**. (You cannot change the user ID.)
 - For the password, enter the default password **admin**. (You can change the Web Control password using the projector's Network menu.)
6. Select **Advanced**.
7. Under **Network**, select **Certificate**.

You see a screen like this:

Network	
Home	Wireless LAN
Initial Setting	Wireless LAN IPv6 Settings
Image	Wired LAN
Signal	Wired LAN IPv6 Settings
Settings	Notifications
Extended	Certificate
Multi-Projection	Client Certificate
Schedule	File <input type="text"/> <input type="button" value="Browse..."/>
Network	<input type="button" value="Send"/>
Info	Password <input type="text"/>
Reset	Issued to
	Issued by
	Expiration Date
	CA certificate
	File <input type="text"/> <input type="button" value="Browse..."/>
	<input type="button" value="Send"/>
	Issued to
	Issued by
	Expiration Date
	Web Server Certificate
	File <input type="text"/> <input type="button" value="Browse..."/>
	<input type="button" value="Send"/>
	Password <input type="text"/>
	Issued to EBECFCFF
	Issued by EBECFCFF
	Expiration Date 2100-01-01 00:00:00
	Select the Apply button after selecting settings. <input type="button" value="Apply"/>
	Others

8. Click the **Browse** button, select the certificate file, and click **Open**.
9. Enter a password in the **Password** box, and click **Send**.
10. When you finish registering the certificate, click **Apply** to finalize your changes and complete the registration.

Parent topic: [Registering a Digital Certificate on the Projector](#)

Related references

[Network Settings - Network Menu](#)

[Digital Certificate Types](#)

Related tasks

[Controlling a Networked Projector Using a Web Browser](#)

Digital Certificate Types

You can register these types of digital certificates.

Client Certificate (PEAP-TLS/EAP-TLS)

Specification	Description
Format	PKCS#12
Extension	PFX, P12
Encryption	RSA
Hashes	MD5/SHA-1/SHA-256/SHA-384/SHA-512
Key length	512/1024/2048/4096 bit
Password	Up to 64 alphanumeric characters; required

CA Certificate (PEAP/PEAP-TLS/EAP-TLS/EAP-FAST)

Specification	Description
Format	X509v3
Extension	DER/CER/PEM
Encryption	RSA
Hashes	MD5/SHA-1/SHA-256/SHA-384/SHA-512
Key length	512/1024/2048/4096 bit
Encoding	BASE64/Binary

Web Server Certificate (Secure HTTP)

Specification	Description
Format	PKCS#12
Extension	PFX, P12
Encryption	RSA
Hashes	MD5/SHA-1/SHA-256/SHA-384/SHA-512
Key length	512/1024/2048/4096 bit

Specification	Description
Common name	Network host name
Organization	Optional
Password	Up to 64 alphanumeric characters; required

Parent topic: [Registering a Digital Certificate on the Projector](#)

Using Basic Projector Features

Follow the instructions in these sections to use your projector's basic features.

[Turning On the Projector](#)

[Turning Off the Projector](#)

[Selecting the Language for the Projector Menus](#)

[Setting the Date and Time](#)

[Resizing the Image with the Zoom Ring](#)

[Resizing the Image using Digital Zoom](#)

[Focusing the Image Using the Focus Ring](#)

[Setting the Screen Type](#)

[Adjusting the Image Position Using Lens Shift](#)

[Adjusting the Image Position Using Image Shift](#)

[Adjusting the Image Position Using Screen Position](#)

[Adjusting the Image Position Horizontally Using Screen Shift](#)

[Displaying a Test Pattern](#)

[Adjusting the Image Height](#)

[Image Shape](#)

[Selecting an Image Source](#)

[Remote Control Operation](#)

[Projection Modes](#)

[Image Aspect Ratio](#)

[Color Mode](#)

[Adjusting the Hue, Saturation, and Brightness](#)

[Adjusting Gamma](#)

[Turning On Dynamic Contrast](#)

[Adjusting the Image Resolution](#)

[Adjusting the Projector's Brightness Level](#)

[Controlling the Volume with the Volume Buttons](#)

[Projecting a PC Free Presentation](#)

[Projecting in Content Playback Mode](#)

Turning On the Projector

Turn on the computer or video equipment you want to use before you turn on the projector so it can display the image source.

1. Connect the power cord to the projector's power inlet.

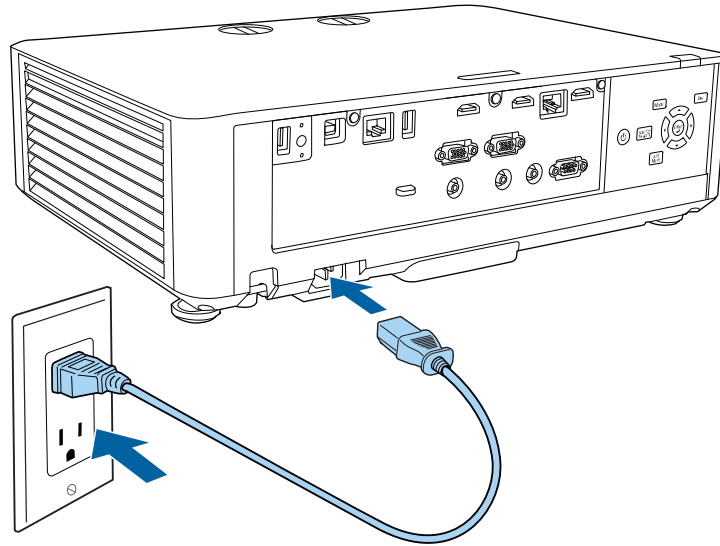

2. Plug the power cord into an electrical outlet.

The projector's On/Standby light turns blue. This indicates that the projector is receiving power, but is not yet turned on (it is in standby mode).

Note: With Direct Power On turned on, the projector turns on as soon as you plug it in.

3. Remove the lens cover, if necessary.
4. Press the power button on the projector or the remote control to turn on the projector.

The projector beeps and the Status light flashes blue as the projector warms up. After about 30 seconds, the Status light stops flashing and turns blue.

Warning: Never look into the projector lens when the laser is on. This can damage your eyes and is especially dangerous for children and pets. When turning on the projector at a distance using the

remote control, make sure there is no one looking into the lens. Make sure no objects are blocking the light from the projector lens. Objects blocking the lens for an extended time can melt and light that is reflected back into the lens can cause the projector to malfunction.

Note: When **Quick Startup** is enabled in the projector's Operation menu, the projector becomes ready for use in several seconds the next time you press the power button.

Note: If the **Auto Source Search** setting in the Operation menu is enabled, the projector automatically detects the input signal when you turn it on. This setting is disabled if the **Quick Startup** or **Content Playback** setting is enabled.

Note: If the **Auto Power On** setting in the Operation menu is enabled, the projector automatically detects the input signal for the HDMI1 or Computer1 ports when you turn it on.

If you do not see a projected image right away, try the following:

- Turn on the connected computer or video device.
- Insert a DVD or other video media, and press the play button (if necessary).
- Change the screen output from the computer if you are using a laptop computer.
- Press the **Source Search** button on the projector or remote control to detect the video source.
- Press the **Home** button and select the source you want to project on the Home screen.

[Using the Home Screen](#)

Parent topic: [Using Basic Projector Features](#)

Related references

[Feature Settings - Operation Menu](#)

Using the Home Screen

You can select input sources and other frequently used options from the Home screen.

1. To display the Home screen, do one of the following:
 - Press the **Home** button on the remote control.
 - Turn on the projector with the **Home Screen Auto Disp** setting enabled.
 - Turn on the projector when no signal is received from the selected input source.

2. Press the arrow buttons on the remote control or control panel to navigate the screen, and press **Enter** to select an option.

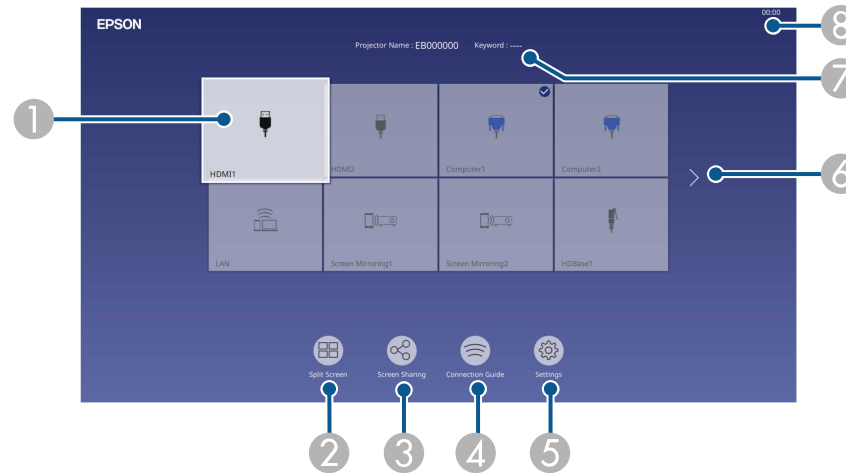

- 1 Selects the source you want to project
A checkmark appears in the upper right corner of the current input source. For most sources, a preview of the input image appears as a thumbnail.
- 2 Projects images from two or four input sources simultaneously in a grid format
- 3 Sends images to or views images from other projectors connected to the same network
- 4 Displays the Connection Guide
You can view steps for different wireless connection methods depending on the devices you are using, such as smartphones or computers.

- 5 Lets you select the following common projector settings (these settings may vary depending on other selected settings):
 - **Color Mode**
 - **Brightness Level**
 - **Volume**
 - **E-Zoom** (PowerLite EB-L630SU/EB-L635SU)
 - **Geometry Correction** (**H/V-Keystone** and **Quick Corner** are available)
 - **Aspect**
- 6 Moves to the previous or next page if there are more available input sources
- 7 Displays the projector name and the projector keyword
- 8 Displays the current time

Note: The Home screen closes after 10 minutes of inactivity.

Parent topic: [Turning On the Projector](#)

Related references

[Display Settings - Display Menu](#)

Turning Off the Projector

Before turning off the projector, shut down any computer connected to it so you can see the computer display during shutdown.

Note: Turn off this product when not in use to prolong the life of the projector. Laser life will vary depending upon mode selected, environmental conditions, and usage. Brightness decreases over time.

1. Press the power button on the projector or the remote control.

2. If you see a shutdown confirmation screen, press the power button on the projector or the remote control again. (To leave the projector on, press any other button.)



The projector beeps twice, the laser turns off, and the Status light turns off.

Note: With Epson's Instant Off technology, there is no cool-down period so you can pack up the projector for transport right away (if necessary).

Note: If the **Light Source Calibration** setting is set to **Run Periodically** in the projector's Management menu, light source calibration starts automatically if you turn off the projector and the following conditions are present:

- 100 hours have passed since the last light source calibration.
- You have used the projector continuously for at least 20 minutes.

3. To transport or store the projector, make sure the Status light is off, then unplug the power cord.
4. Attach the lens cover.

Parent topic: [Using Basic Projector Features](#)

Related references

[Administration Settings - Management Menu](#)

Selecting the Language for the Projector Menus

If you want to view the projector's menus and messages in another language, you can change the Language setting.

1. Turn on the projector.
2. Press the **Menu** button.

3. Select the **Management** menu and press **↵ Enter**.

Frequently Used Items	Management	
Image	User Button	Light Source Mode
Signal I/O	User's Logo	
Installation	Control Panel Lock	Off
Display	Color Uniformity	
Operation	Refresh Mode	
Management	Light Source Calibration	
Network	Date & Time	
Multi-Projection	Schedule Settings	
Memory	Wireless LAN Power	
Initial/All Settings	Wireless LAN Diagnosis	1
	Log Save Destination	USB and Internal Memory
	Batch Setup Range	
	Language 🌐	English
	Information	
	Display Logs	
	Reset Management Settings	
	Network	

4. Select the **Language** setting and press **↵ Enter**.
5. Select the language you want to use and press **↵ Enter**.
6. Press **Menu** or **Esc** to exit the menus.

Parent topic: [Using Basic Projector Features](#)

Related references

[Administration Settings - Management Menu](#)

Setting the Date and Time

You can set the date and time for the projector.

1. Press the **Menu** button.
2. Select the **Management** menu and press **↵ Enter**.
3. Select the **Date & Time** setting and press **↵ Enter**.

You see a screen like this:

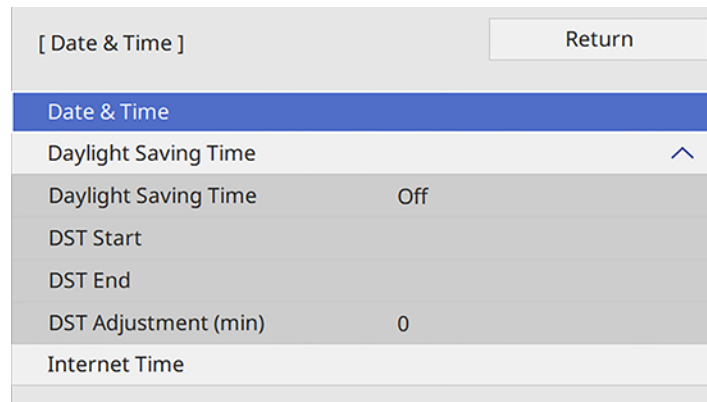

4. Select the **Date & Time** setting and press **↵ Enter**.
5. Select **Date**, press **↵ Enter**, and use the displayed keyboard to enter today's date.
6. Select **Time**, press **↵ Enter**, and use the displayed keyboard to enter the current time.
7. Adjust the **Time Difference (UTC)** settings to set the time difference from the Coordinated Universal Time.
8. When you are finished, select **Set** and press **↵ Enter**.
9. To activate daylight saving time, select the **Daylight Saving Time** setting and set it to **On**. Then select settings.
10. When you are finished, select **Set** and press **↵ Enter**.
11. To update the time automatically through an internet time server, select the **Internet Time** setting and set it to **On**.
12. Select **Internet Time** and press **↵ Enter**.
13. Enter the IP address for the Internet time server you want to use and select **OK**.
14. Select **Set** and press **↵ Enter**.
15. Press **Menu** or **Esc** to exit the menus.

Parent topic: [Using Basic Projector Features](#)

Related references

[Administration Settings - Management Menu](#)

Resizing the Image with the Zoom Ring

You can resize the image using the projector's zoom ring (not available for the PowerLite EB-L630SU/EB-L635SU).

1. Turn on the projector and display an image. Wait 20 minutes after turning on the projector before setting the focus, zoom, and lens shift for maximum accuracy.
2. To enlarge or reduce the image size, rotate the projector's zoom ring.

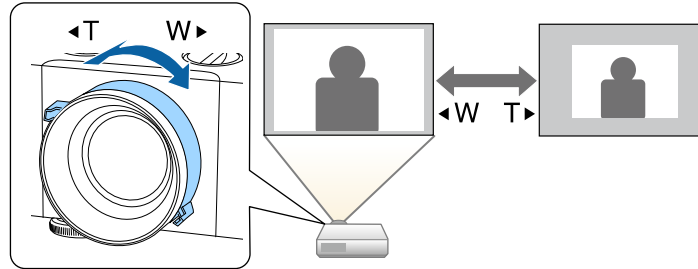

Parent topic: [Using Basic Projector Features](#)

Resizing the Image using Digital Zoom

You can resize the image using the **Digital Zoom** menu option (PowerLite EB-L630SU/EB-L635SU). Wait at least 20 minutes after you start projecting to adjust the image size.

1. Turn on the projector and display an image.
2. Press the **Menu** button on the control panel or remote control.

3. Select the **Installation** menu.

Frequently Used Items	Installation	
Image	Fixed Installation	Off
Signal I/O	Test Pattern	
Installation	Projection	Front/Ceiling
Display	Geometry Correction	Point Correction
Operation	Remote Receiver	Off
Management	Screen Type	16:9
Network	High Altitude Mode	Off
Multi-Projection	Source	Computer1
Memory	Blanking	
Initial/All Settings	Reset to Defaults	
	Reset Installation Settings	
	Display	
	No-signal Screen	Blue
	Startup Screen	On
	Home Screen Auto Disp.	On
	Sort Source Thumbnails	On
	Messages	On

4. Select the **Digital Zoom** setting.
5. Press the left and right arrow buttons on the control panel or remote control to adjust the image size.
6. When you are finished, press the **Esc** button.

Parent topic: [Using Basic Projector Features](#)

Related references

[Installation Settings - Installation Menu](#)

Focusing the Image Using the Focus Ring

1. Turn on the projector and display an image. Wait 20 minutes after turning on the projector before setting the focus, zoom, and lens shift for maximum accuracy.

2. To sharpen the image focus, rotate the projector's focus ring.

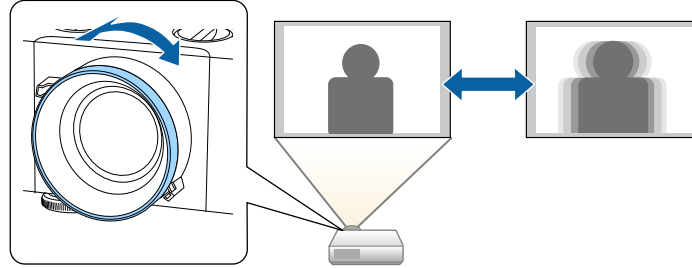

Parent topic: [Using Basic Projector Features](#)

Setting the Screen Type

You can use the Screen Type setting to match the aspect ratio of the displayed image to the screen you are using.

Note: This setting is unavailable when using the **USB** or **LAN** input source.

Note: If you change the **Screen Type** setting, the **Geometry Correction** settings are initialized. You cannot change the **Screen Type** setting when the **Content Playback** setting is enabled.

Note: Certain screen type settings are only available on select projector models.

1. Turn on the projector and display an image.
2. Press the **Menu** button.
3. Select the **Installation** menu and press **↵ Enter**.
4. Select the **Screen Type** setting and press **↵ Enter**.

You see a screen like this:

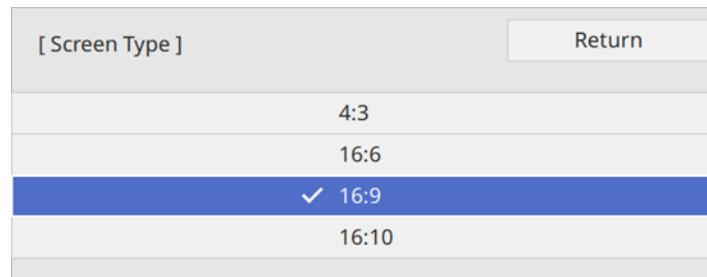

5. Select your screen's aspect ratio and press **↵ Enter**.
6. Press the **Menu** button to exit.
7. Adjust the aspect ratio for the projected image, if necessary.

Parent topic: [Using Basic Projector Features](#)

Related references

[Installation Settings - Installation Menu](#)

Adjusting the Image Position Using Lens Shift

If you cannot install the projector directly in front of the screen, you can adjust the position of the projected image using the lens shift feature (not available on the PowerLite EB-L520U).

Follow these guidelines when using lens shift to adjust your images:

- When adjusting the image height, position the image lower than where you want it to be and then move it up using the vertical lens shift dial. This helps prevent the image from moving down after adjustment.
1. Turn on the projector and display an image.

- Turn the vertical and horizontal lens shift dials on the projector to adjust the position of the projected image as necessary.

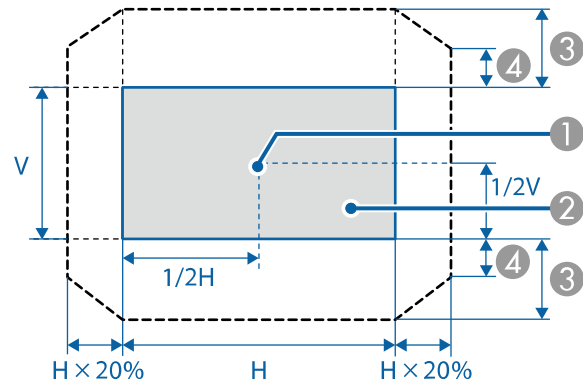
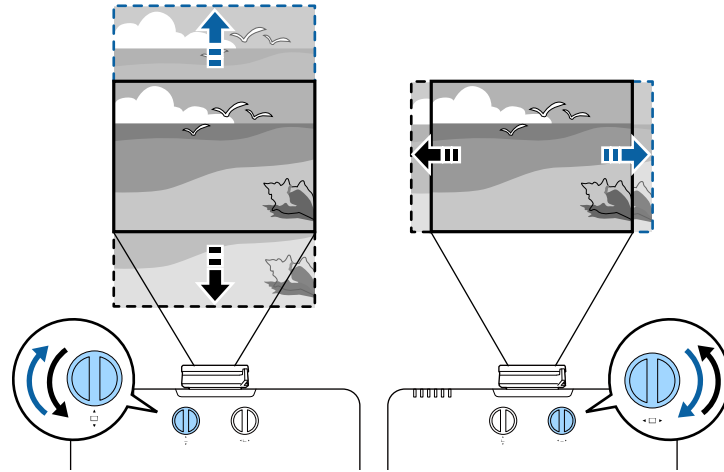

- Center of lens
- Projected image when the lens is set to the home position
- Maximum range: $V \times 50\%$
- When the horizontal direction is at the maximum value: $V \times 12\%$

Parent topic: [Using Basic Projector Features](#)

Adjusting the Image Position Using Image Shift

You can use the Image Shift feature to adjust the image position without moving the projector (PowerLite EB-L630SU/EB-L635SU). Wait at least 20 minutes after you start projecting to adjust the image position.

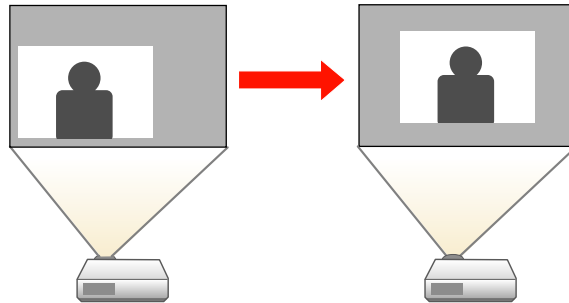

Note: This feature is not available if the **Zoom** option is set to the widest setting.

1. Turn on the projector and display an image.
2. Adjust the image size using the right and left arrow buttons.
After you adjust the image size, the Image Shift screen is displayed automatically.
3. Use the arrow buttons on the projector or remote control to adjust the image position.

Note: You can also use the Installation menu to adjust the **Image Shift** setting.

4. Press **Esc** to close the Image Shift screen. The screen closes if no operation is performed for approximately 10 seconds.

Note: The Image Shift setting is retained even if the projector is turned off; however, you need to readjust the image position if you change the projector's location or angle.

Parent topic: [Using Basic Projector Features](#)

Adjusting the Image Position Using Screen Position

You can adjust the image position if there are margins between the edge of the image and the projected screen frame.

Note: You cannot adjust the screen position if the **Screen Type** setting is set to **16:10**.

1. Turn on the projector and display an image.
2. Press the **Menu** button.
3. Select **Installation > Screen Position** and press **↵ Enter**.
4. Use the arrow buttons on the remote control or projector to adjust the position of the image.

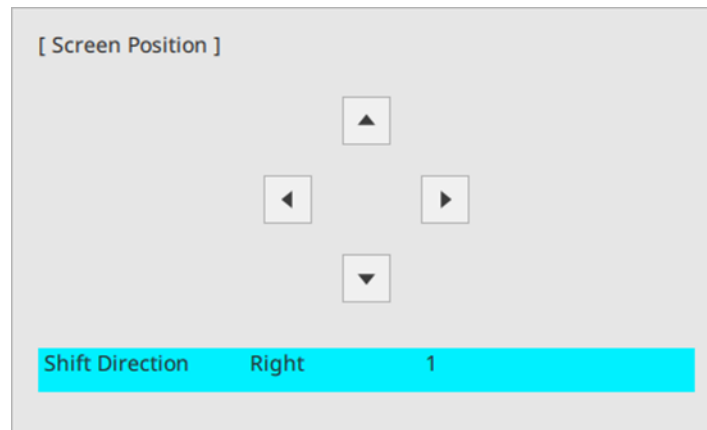

5. When you are finished, press the **Esc** button.

Parent topic: [Using Basic Projector Features](#)

Adjusting the Image Position Horizontally Using Screen Shift

You can use the Screen Shift feature to adjust the image position horizontally without moving the projector when the **Screen Type** is set to **16:6**.

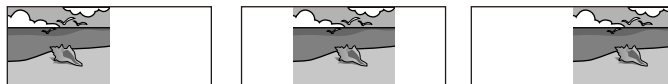

Note: This feature is only available when the **Aspect** setting is set to **Auto** for the HDMI, Computer, and HDBaseT sources. It is not available when projecting split screen images.

1. Turn on the projector and display an image.
2. Press the following buttons on the remote control to position the image:
 - **4**: positions the image to the left side of the screen
 - **5**: positions the image in the center of the screen
 - **6**: positions the image to the right side of the screen
3. When you are finished, press **Esc**.

Note: The adjusted image location is only saved until the projector is turned off.

Parent topic: [Using Basic Projector Features](#)

Displaying a Test Pattern

You can display a test pattern to adjust the projected image without connecting a computer or video device.

Note: The test pattern's shape is determined by the **Screen Type** setting. Be sure to set the correct screen type before adjusting with the test pattern.

1. Turn on the projector.
2. Press the down arrow button on the control panel.

Note: You can also display a test pattern from the Installation menu using the remote control.

3. Press the  left or right arrow button on the remote control, or press **Enter** on the control panel to cycle through the available test patterns.

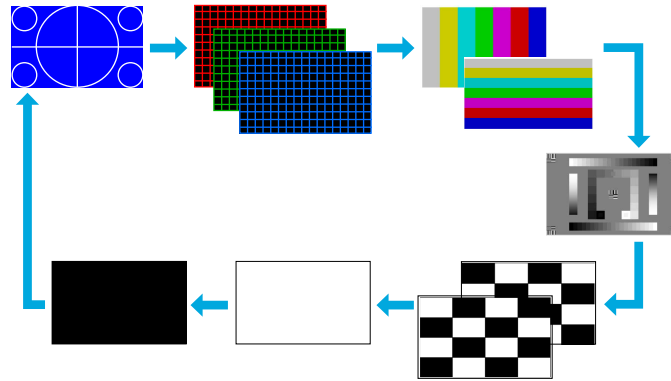

4. Adjust the image as necessary.
5. Press the **Esc** button to clear the test pattern.

Parent topic: [Using Basic Projector Features](#)

Adjusting the Image Height

If you are projecting from a table or other flat surface, and the image is too high or low, you can adjust the image height using the projector's adjustable feet.

1. Turn on the projector and display an image.
2. To adjust the image height, rotate the front foot to extend or retract it.

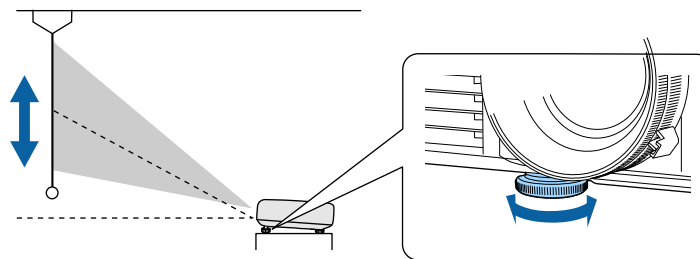

3. If the image is tilted, rotate the rear feet to adjust their height.

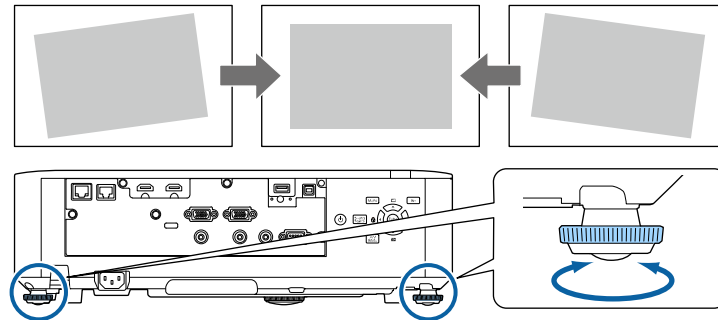

If the projected image is unevenly rectangular, you need to adjust the image shape.

Parent topic: [Using Basic Projector Features](#)

Image Shape

You can project an evenly rectangular image by placing the projector directly in front of the center of the screen and keeping it level. If you place the projector at an angle to the screen, or tilted up or down, or off to the side, you may need to correct the image shape for the best display quality.

Note: After correction, your image is slightly smaller. For the best quality images, try to adjust the projector's position to achieve the correct image size and shape. After you have corrected the position of the projector, you can use the adjustments in this section to correct the image shape. You cannot combine the **H/V-Keystone** setting with other correction methods.

[Correcting Image Shape with H/V-Keystone](#)

[Correcting Image Shape with Quick Corner](#)

[Correcting Image Shape with Arc Correction](#)

[Correcting Image Shape with Point Correction](#)

[Applying Saved Image Shape Settings](#)

Parent topic: [Using Basic Projector Features](#)

Correcting Image Shape with H/V-Keystone

You can use the projector's **H/V-Keystone** setting to correct the shape of an image that is unevenly rectangular on the sides.

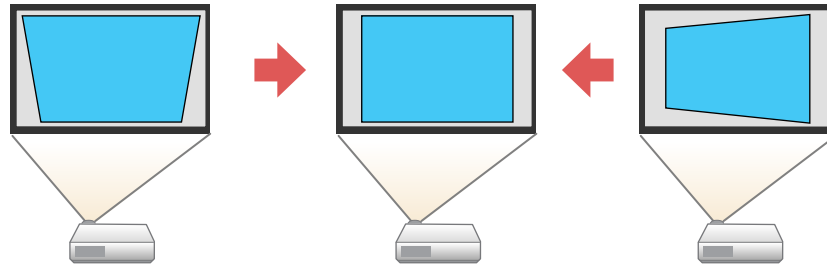

Note: You cannot combine H/V-Keystone correction with other image shape correction methods.

1. Turn on the projector and display an image.
2. Press the **Menu** button.

3. Select the **Installation** menu and press **↵ Enter**.

Frequently Used Items	Installation	
Image	Fixed Installation	Off
Signal I/O	Test Pattern	
Installation	Projection	Front/Ceiling
Display	Geometry Correction	Point Correction
Operation	Remote Receiver	Off
Management	Screen Type	16:9 ▼
Network	High Altitude Mode	Off
Multi-Projection	Source	Computer1
Memory	Blanking	
Initial/All Settings	Reset to Defaults	
	Reset Installation Settings	
	Display	
	No-signal Screen	Blue
	Startup Screen	On
	Home Screen Auto Disp.	On
	Sort Source Thumbnails	On
	Messages	On
	Message	Off

4. Select the **Geometry Correction** setting and press **↵ Enter**.
5. Select the **H/V-Keystone** setting and press **↵ Enter**. Then press **↵ Enter** again.
You see the H/V-Keystone adjustment screen:

[H/V-Keystone]		Return
V-Keystone	50	◀ ————— ▶
V-Balance	30	—————
H-Keystone	50	—————
H-Balance	30	—————

6. Use the arrow buttons on the projector or the remote control to select between vertical and horizontal keystone or balance correction and to adjust the image shape as necessary.

V-Keystone

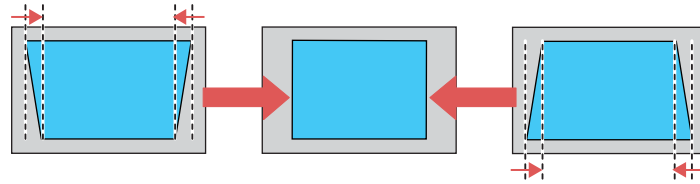

V-Balance

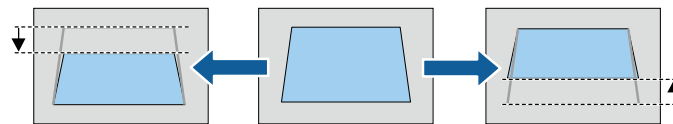

H-Keystone

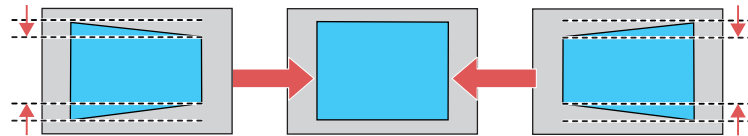

H-Balance

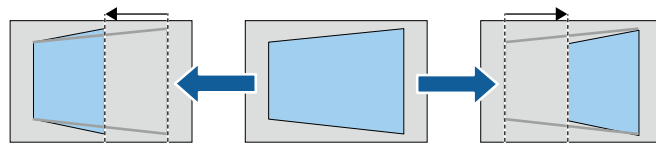

Note: The V-Balance and H-Balance settings are not available on the PowerLite EB-L520U.

7. When you are finished, press **Esc**.

After correction, your image is slightly smaller.

Parent topic: [Image Shape](#)

Related references

[Installation Settings - Installation Menu](#)

Correcting Image Shape with Quick Corner

You can use the projector's Quick Corner setting to correct the shape and size of an image that is unevenly rectangular on all sides.

Note: To provide the best possible image quality, adjust the projector's position to correct the image shape. If this isn't possible, use the Quick Corner setting to correct the image shape.

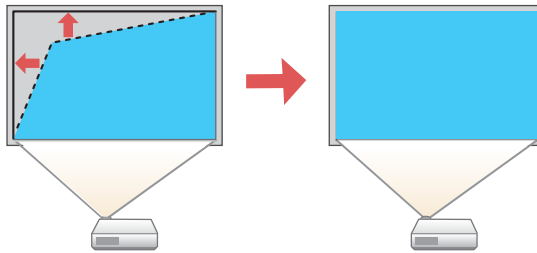

Note: If you change the **Screen Type** or **Screen Position** setting, your image adjustments are reset.

1. Turn on the projector and display an image.
2. Press the **Menu** button.

3. Select the **Installation** menu and press **↵ Enter**.

Frequently Used Items	Installation	
Image	Fixed Installation	Off
Signal I/O	Test Pattern	
Installation	Projection	Front/Ceiling
Display	Geometry Correction	Point Correction
Operation	Remote Receiver	Off
Management	Screen Type	16:9 ▼
Network	High Altitude Mode	Off
Multi-Projection	Source	Computer1
Memory	Blanking	
Initial/All Settings	Reset to Defaults	
	Reset Installation Settings	
	Display	
	No-signal Screen	Blue
	Startup Screen	On
	Home Screen Auto Disp.	On
	Sort Source Thumbnails	On
	Messages	On
	Message Beep	Off

4. Select the **Geometry Correction** setting and press **↵ Enter**.
5. Select the **Quick Corner** setting and press **↵ Enter**.

You see the Quick Corner adjustment screen:

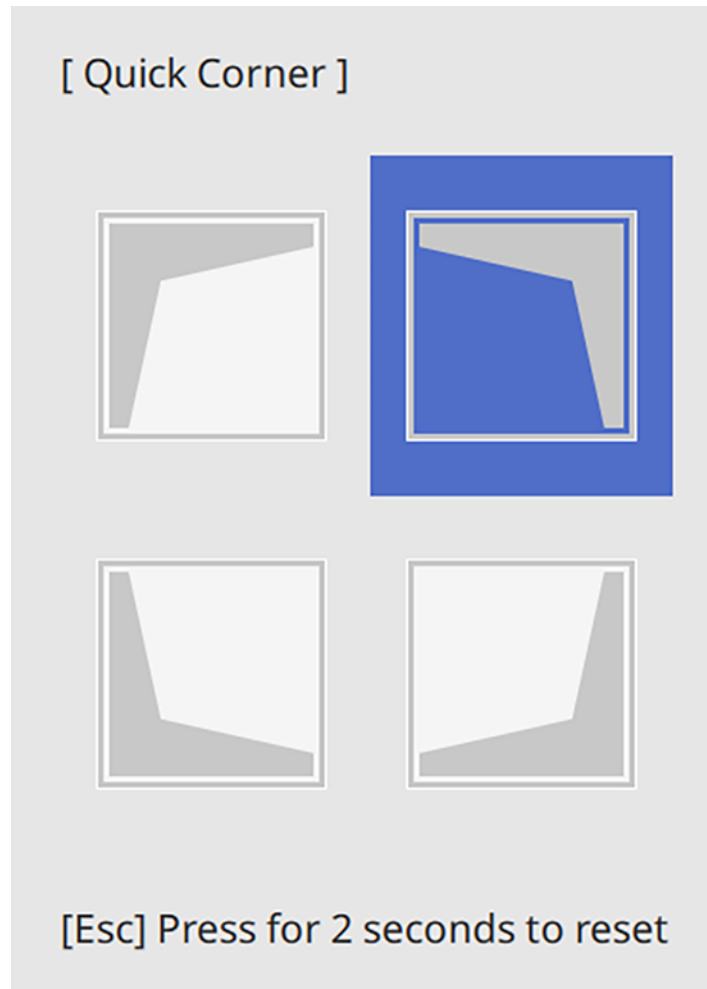

6. Use the arrow buttons on the projector or remote control to select the corner of the image you want to adjust. Then press **↵ Enter**.

Note: To reset your adjustments, press and hold the **Esc** button for at least 2 seconds to display a reset screen. Then select **Yes**.

7. Press the arrow buttons to adjust the image shape as necessary. Press **↵ Enter** to return to the area selection screen.

Note: You can also use the numeric buttons on the remote control to adjust the image shape. If one of the directional arrows on the screen turns gray, you cannot adjust the shape any further in that direction.

8. When you are finished, press **Esc**.

The **Geometry Correction** setting is now set to **Quick Corner** in the projector's Installation menu. If you press the keystone adjustment buttons on the control panel, the area selection screen appears.

Note: To save the current image shape, select **Memory > Save Memory**. You can save up to three image shapes in the projector's memory.

Parent topic: [Image Shape](#)

Related references

[Installation Settings - Installation Menu](#)

Correcting Image Shape with Arc Correction

You can use the projector's Arc Correction setting to adjust the curve or arc of the sides of your image.

Note: If you change the **Screen Type** setting or adjust the image position, your image adjustments are reset.

1. Turn on the projector and display an image.
2. Press the **Menu** button.
3. Select the **Installation** menu and press **↵ Enter**.

Frequently Used Items	Installation	
Image	Fixed Installation	Off
Signal I/O	Test Pattern	
Installation	Projection	Front/Ceiling
Display	Geometry Correction	Point Correction
Operation	Remote Receiver	Off
Management	Screen Type	16:9 ▼
Network	High Altitude Mode	Off
Multi-Projection	Source	Computer1
Memory	Blanking	
Initial/All Settings	Reset to Defaults	
	Reset Installation Settings	
	Display	
	No-signal Screen	Blue
	Startup Screen	On
	Home Screen Auto Disp.	On
	Sort Source Thumbnails	On
	Messages	On
	Mute	Off

4. Select the **Geometry Correction** setting and press **↵ Enter**.
5. Select the **Arc Correction** setting and press **↵ Enter**. Then select the **Arc Correction** setting and press **↵ Enter** again.

You see the Arc Correction adjustment screen:

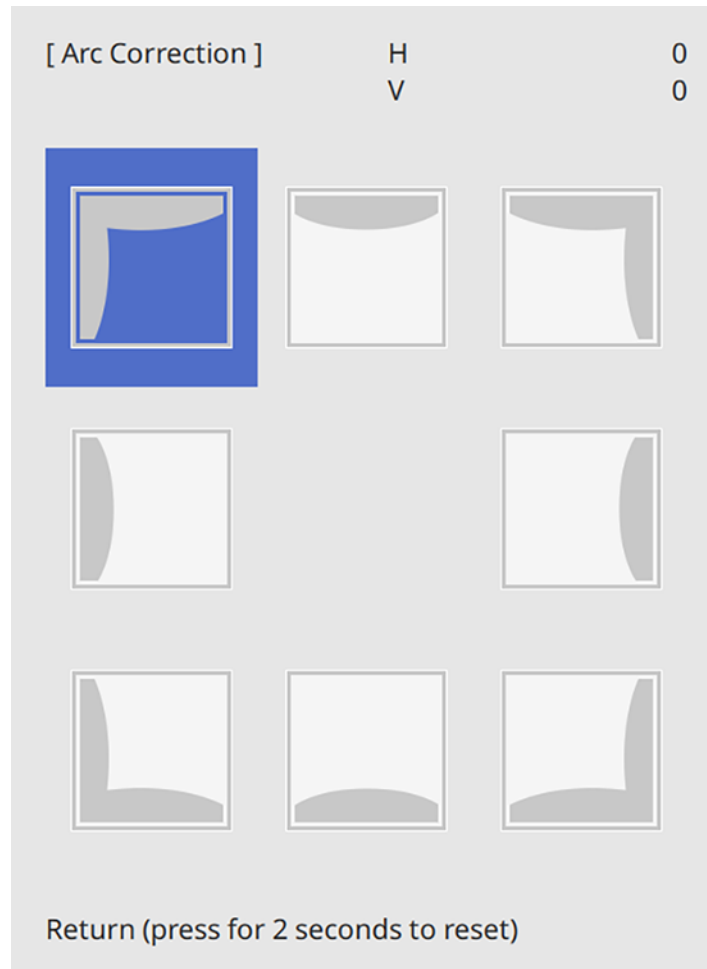

Note: To reset your adjustments, press the **Esc** button for at least 2 seconds to display a reset screen, and select **Yes**.

6. Use the arrow buttons on the projector or the remote control to select the corner or side of the image you want to adjust. Then press **↵ Enter**.
7. Press the arrow buttons to adjust the image shape as necessary.

- When you are finished, press **Esc**.

Note: To save the current image shape, select **Memory > Save Memory**. You can save up to three image shapes in the projector's memory.

Parent topic: [Image Shape](#)

Related references

[Installation Settings - Installation Menu](#)

Correcting Image Shape with Point Correction

You can use the projector's Point Correction feature to fine-tune the image shape using points on a grid. This is useful for adjusting overlapping areas in multiple projected images that do not line up correctly.

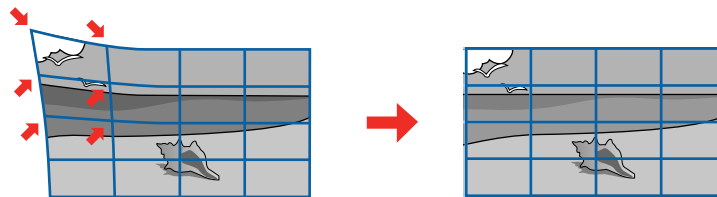

- Turn on the projector and display an image.
- Press the **Menu** button.
- Select **Installation > Geometry Correction > Point Correction**.

Note: If you see a confirmation message, select **Yes** and press **↵ Enter**.

- Select the **Point Correction** setting again and press **↵ Enter**.

Note: For fine tuning, select **Quick Corner** to roughly correct the shape and size of an image and then select **Point Correction** to adjust them more precisely.

- Select the number of grid lines to display and press **↵ Enter**.

You see a grid on the projected image.

Note: If you need to change the color of the grid lines, press **Esc**, select the **Pattern Color** setting, and select a suitable color.

6. Press the arrow buttons on the projector or remote control to move to the point on the grid that you want to adjust. Then press **↵ Enter**.

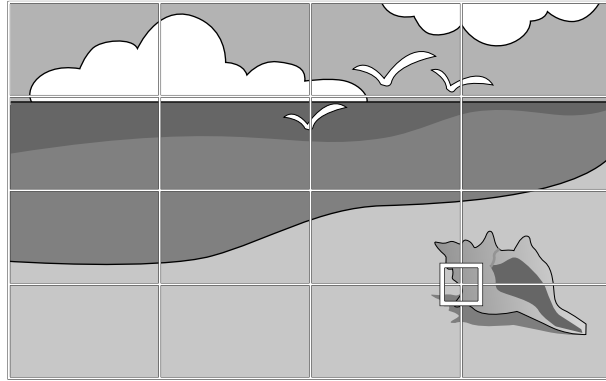

7. Press the arrow buttons as necessary to correct the image shape.

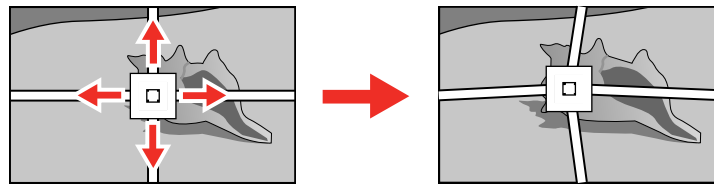

8. Press **Esc** to return to the previous screen and select another point to correct, if necessary.
9. When you are finished, press the **Menu** button.

Note: If necessary, you can fine-tune your image adjustments using the **Quick Corner** setting.

Parent topic: [Image Shape](#)

Related references

[Installation Settings - Installation Menu](#)

Related tasks

[Correcting Image Shape with Quick Corner](#)

Applying Saved Image Shape Settings

You can load the image shape settings you selected and saved to the projector's memory and apply them to the current image.

1. Turn on the projector and display an image.
2. Hold down the **Num** button on the remote control and press the number button (1, 2, or 3) that matches the number of the saved image shape setting.

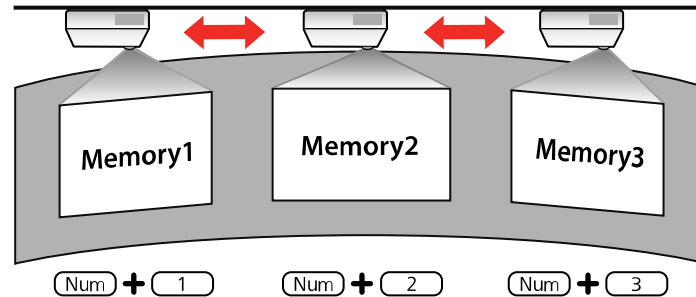

The saved image shape setting is applied and you are prompted to calibrate the screen.

3. Follow the on-screen instructions to calibrate the screen.

Parent topic: [Image Shape](#)

Selecting an Image Source

If you connected multiple image sources to the projector, such as a computer and DVD player, you may want to switch from one image source to the other.

Note: If you turned on the **Auto Source Search** setting in the Operation menu, the projector automatically switches to another detected image source if the signal to the current image source is lost.

1. Make sure the connected image source you want to use is turned on.
2. For video image sources, insert a DVD or other video media and press its play button, if necessary.
3. Do one of the following:
 - Press the **Source Search** button on the projector or remote control until you see the image from the source you want.

- Press the button for the source you want on the remote control. If there is more than one port for that source, press the button again to cycle through the sources.

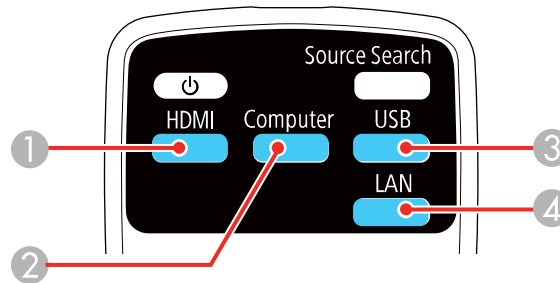

- 1 HDMI sources
- 2 VGA port sources
- 3 USB port sources (computer display or external devices)
- 4 Network and Screen Mirroring sources

- Press the **Home** button on the remote control or projector and select your image source.

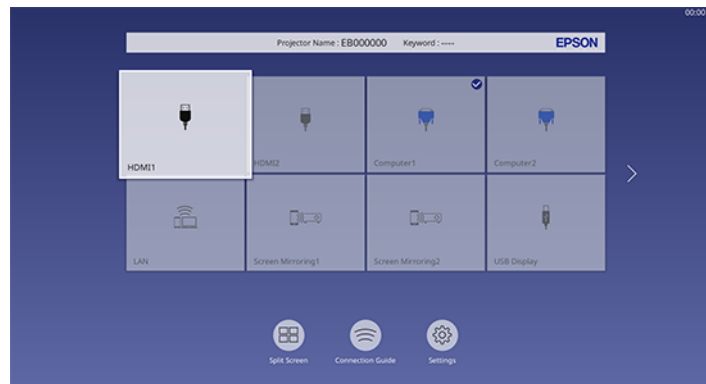

Note: Your Home screen may look different from the illustration shown here. A checkmark appears on the image from the current input source. You can see thumbnail previews of most input sources.

Parent topic: [Using Basic Projector Features](#)

Related references

[Feature Settings - Operation Menu](#)

Related tasks

[Using the Home Screen](#)

Remote Control Operation

The remote control lets you control the projector from almost anywhere in the room, up to 26 feet (8 m) away. You can point it at the front or rear of the projector.

Make sure that you aim the remote control at the projector's receivers within the angles listed here.

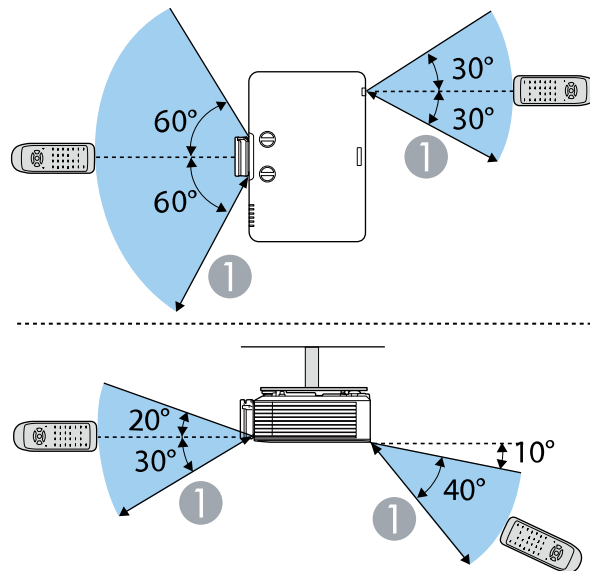

1 26 feet (8 m)

Note: Avoid using the remote control in conditions with bright fluorescent lights or in direct sunlight, or the projector may not respond to commands. If you will not use the remote control for a long time, remove the batteries.

Parent topic: [Using Basic Projector Features](#)

Projection Modes

Depending on how you positioned the projector, you may need to change the projection mode so your images project correctly.

- **Front** (default setting) lets you project from a table in front of the screen.
- **Front/Ceiling** flips the image over top-to-bottom to project upside-down from a ceiling or wall mount.
- **Rear** flips the image horizontally to project from behind a translucent screen.
- **Rear/Ceiling** flips the image over top-to-bottom and horizontally to project from the ceiling and behind a translucent screen.

Note: You can change the projection mode using the remote control or by changing the **Projection** setting in the Installation menu.

[Changing the Projection Mode Using the Remote Control](#)

[Changing the Projection Mode Using the Menus](#)

Parent topic: [Using Basic Projector Features](#)

Related references

[Installation Settings - Installation Menu](#)

Changing the Projection Mode Using the Remote Control

You can change the projection mode to flip the image over top-to-bottom.

1. Turn on the projector and display an image.
2. Hold down the **A/V Mute** button on the remote control for 5 to 10 seconds.

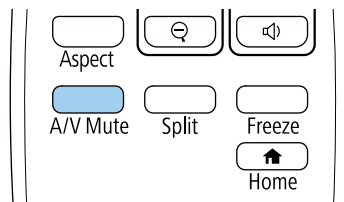

The image disappears briefly and reappears flipped top-to-bottom.

3. To change projection back to the original mode, hold down the **A/V Mute** button for 5 to 10 seconds again.

Parent topic: [Projection Modes](#)

Changing the Projection Mode Using the Menus

You can change the projection mode to flip the image over top-to-bottom and/or left-to-right using the projector menus.

1. Turn on the projector and display an image.
2. Press the **Menu** button.
3. Select the **Installation** menu and press **↵ Enter**.

Frequently Used Items	Installation	
Image	Fixed Installation	Off
Signal I/O	Test Pattern	
Installation	Projection	Front/Ceiling
Display	Geometry Correction	Point Correction
Operation	Remote Receiver	Off
Management	Screen Type	16:9 ▼
Network	High Altitude Mode	Off
Multi-Projection	Source	Computer1
Memory	Blanking	
Initial/All Settings	Reset to Defaults	
	Reset Installation Settings	
	Display	
	No-signal Screen	Blue
	Startup Screen	On
	Home Screen Auto Disp.	On
	Sort Source Thumbnails	On
	Messages	On
	Message Beep	Off

4. Select the **Projection** setting and press **↵ Enter**.
5. Select a projection mode and press **↵ Enter**.
6. Press **Menu** or **Esc** to exit the menus.

Parent topic: [Projection Modes](#)

Related references

[Installation Settings - Installation Menu](#)

Image Aspect Ratio

The projector can display images in different width-to-height ratios called aspect ratios. Normally the input signal from your video source determines the image's aspect ratio setting. However, for certain images you can change the aspect ratio to fit your screen.

[Changing the Image Aspect Ratio](#)

[Available Image Aspect Ratios](#)

Parent topic: [Using Basic Projector Features](#)

Changing the Image Aspect Ratio

You can change the aspect ratio of the displayed image to resize it.

Note: Set the **Screen Type** setting in the projector's Installation menu before changing the aspect ratio.

Note: This setting is available only when the **Scale** setting is turned off or the **Scale Mode** setting is set to **Full Display**.

Note: You may not be able to set the aspect ratio for all sources.

1. Turn on the projector and switch to the image source you want to use.
2. Press the **Aspect** button on the remote control.

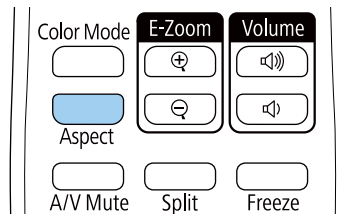

The shape and size of the displayed image changes, and the name of the aspect ratio appears briefly on the screen.

3. To cycle through the available aspect ratios for your input signal, press the **Aspect** button repeatedly.

Note: To remove black bars when projecting from a computer, set the **Resolution** setting to **Wide** or **Normal** in the Image menu, depending on your computer's resolution.

Parent topic: [Image Aspect Ratio](#)

Related references

[Installation Settings - Installation Menu](#)

[Image Quality Settings - Image Menu](#)

Available Image Aspect Ratios

You can select the following image aspect ratios, depending on the selected Screen Type setting and the input signal from your image source.

Note: Black bands and cropped or stretched images may project in certain aspect ratios, depending on the aspect ratio and resolution of your input signal.

Note: Using the aspect ratio of the projector to reduce, enlarge, or split the projected image for commercial purposes or for public viewing may infringe on the rights of the copyright holder of that image based on copyright law.

Aspect ratio setting	Description
Auto	Automatically sets the aspect ratio according to the input signal.
Full	Displays images using the full size of the projection area, but does not maintain the aspect ratio.
H-Zoom V-Zoom	Displays images using the full width (H-Zoom) or full height (V-Zoom) of the projection area and maintains the aspect ratio of the image. Areas that exceed the edges of the projected screen are not projected.
Native	Displays images as is (aspect ratio and resolution are maintained). Areas that exceed the edges of the projected screen are not projected.

Note: The appearance of the **Native** image aspect ratio setting varies depending on the input signal.

If there are margins between the image edges and the screen, you can adjust the position of the projected image using the **Screen Position** setting in the Installation menu.

Parent topic: [Image Aspect Ratio](#)

Related references

[Installation Settings - Installation Menu](#)

Color Mode

The projector offers different Color Modes to provide optimum brightness, contrast, and color for a variety of viewing environments and image types. You can select a mode designed to match your image and environment, or experiment with the available modes.

[Changing the Color Mode](#)

[Available Color Modes](#)

Parent topic: [Using Basic Projector Features](#)

Changing the Color Mode

You can change the projector's Color Mode using the remote control to optimize the image for your viewing environment.

1. Turn on the projector and switch to the image source you want to use.
2. If you are projecting from a DVD player or other video source, insert a disc or other video media and press the play button, if necessary.
3. Press the **Color Mode** button on the remote control to change the Color Mode.

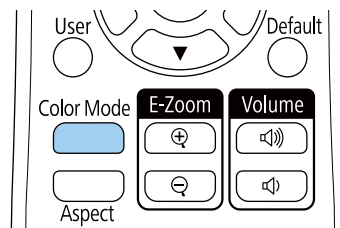

A list of available Color Modes appears.

4. To cycle through all the available Color Modes for your input signal, keep pressing the **Color Mode** button.
5. Press **Enter** to select a Color Mode.

Parent topic: [Color Mode](#)

Available Color Modes

You can set the projector to use these Color Modes, depending on the input source you are using:

Color Mode	Description
Dynamic	Best for projecting in a bright room
Presentation	Best for color presentations in a bright room
Cinema	Best for movies projected in a dark room
sRGB	Best for standard sRGB computer displays
DICOM SIM*	Best for projecting X-ray photographs and other medical images
Multi-Projection	Best for projecting from multiple projectors (reduces the color tone difference between images)

* Available only when inputting RGB signals

Note: The **DICOM SIM** Color Mode is for reference purposes only and should not be used to make medical diagnoses.

Parent topic: [Color Mode](#)

Adjusting the Hue, Saturation, and Brightness

You can adjust the hue, saturation, and brightness settings for individual image colors.

1. Turn on the projector and switch to the image source you want to use.
2. Press the **Menu** button.

3. Select the **Image** menu and press **↵ Enter**.

Frequently Used Items	Image	
Image	Color Mode	Presentation
Signal I/O	Brightness	50
Installation	Contrast	50
Display	Color Saturation	50
Operation	Tint	50
Management	Sharpness	50
Network	White Balance	
Multi-Projection	Dynamic Contrast	Off
Memory	Image Enhancement	
Initial/All Settings	Scene Adaptive Gamma	5
	Gamma	0
	RGBCMY	
	Reset to Defaults	
	Source	Computer1
	Resolution	Auto
	Aspect	Auto
	Analog Signal Adjustment	
	Reset to Defaults	

4. Select **RGBCMY** and press **↵ Enter**.
5. Select the color to adjust and press **↵ Enter**.

[RGBCMY]		Return	
	Hue	Saturation	Brightness
R	50	50	50
G	50	50	50
B	50	50	50
C	50	50	50
M	50	50	50
Y	50	50	50

6. Do the following as necessary for each setting:
 - To adjust the overall hue of the color (bluish, greenish, reddish), adjust the **Hue** setting.
 - To adjust the overall vividness of the color, adjust the **Saturation** setting.
 - To adjust the overall brightness of the color, adjust the **Brightness** setting.

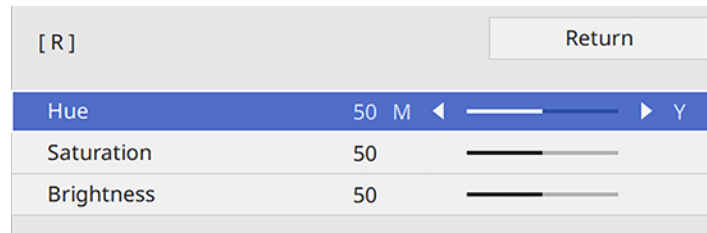

7. Press **Menu** or **Esc** to exit the menus.

Parent topic: [Using Basic Projector Features](#)

Adjusting Gamma

You can adjust the gamma to improve differences in halftone brightness that vary depending on the connected device.

Note: Project a still image to adjust the gamma; you cannot adjust it properly when projecting a movie or other moving video. Medical images may not reproduce correctly depending on your operating environment and screen.

1. Turn on the projector and switch to the image source you want to use.
2. Press the **Menu** button.

3. Select the **Image** menu and press **↵ Enter**.

Frequently Used Items	Image	
Image	Color Mode	Presentation
Signal I/O	Brightness	50
Installation	Contrast	50
Display	Color Saturation	50
Operation	Tint	50
Management	Sharpness	50
Network	White Balance	
Multi-Projection	Dynamic Contrast	Off
Memory	Image Enhancement	
Initial/All Settings	Scene Adaptive Gamma	5
	Gamma	0
	RGBCMY	
	Reset to Defaults	
	Source	Computer1
	Resolution	Auto
	Aspect	Auto
	Analog Signal Adjustment	
	Reset to Defaults	

4. Select the **Gamma** setting and press **↵ Enter**.
5. Select and adjust the correction value.

You see a screen like this:

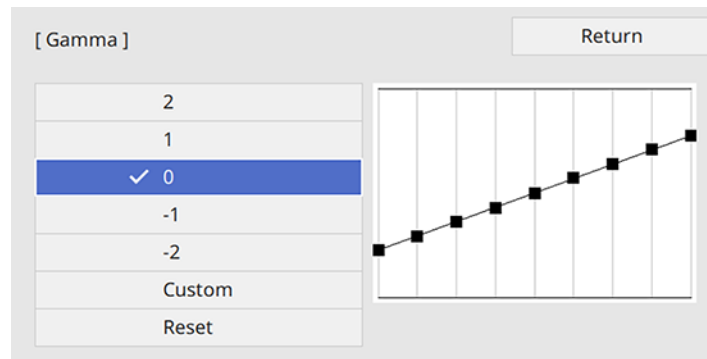

When you select a smaller value, you can reduce the overall brightness of the image to make the image sharper. When you select a larger value, the dark areas of images become brighter, but the color saturation for lighter areas may become weaker.

Note: If you set the **Color Mode** setting to **DICOM SIM** in the projector's **Image** menu, select the adjustment value according to the projection size. If the projection size is 80 inches (203 cm) or less, select a small value. If the projection size is 80 inches or more, select a large value.

6. If you want to make finer adjustments, select **Custom** and press **↵ Enter**.
7. Press the left or right arrow button to select the tone you want to change, then press the up or down arrow button to adjust the tone and press **↵ Enter**.

You see a screen like this:

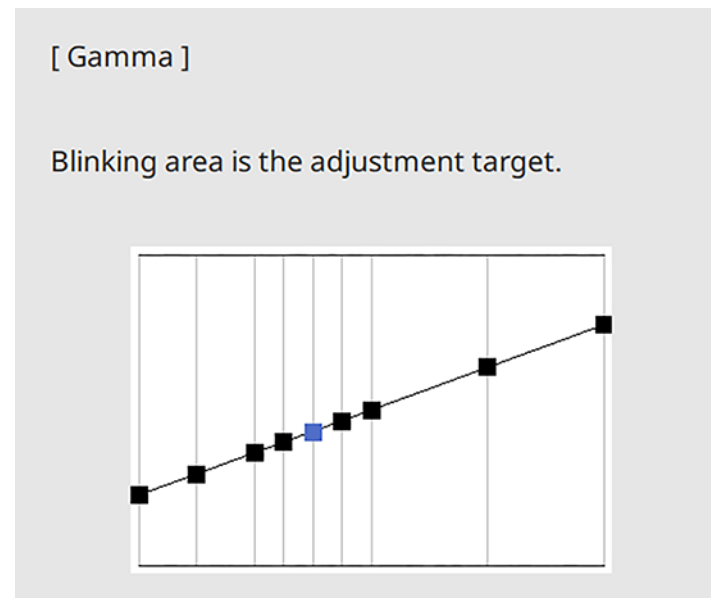

8. Press **Menu** or **Esc** to exit the menus.

Parent topic: [Using Basic Projector Features](#)

Related references

[Image Quality Settings - Image Menu](#)

Turning On Dynamic Contrast

You can turn on the **Dynamic Contrast** setting to automatically optimize the image luminance. This improves the image contrast based on the brightness of the content you project.

1. Turn on the projector and switch to the image source you want to use.
2. Press the **Menu** button.
3. Select the **Image** menu and press **Enter**.

Frequently Used Items	Image	
Image	Color Mode	Presentation
Signal I/O	Brightness	50
Installation	Contrast	50
Display	Color Saturation	50
Operation	Tint	50
Management	Sharpness	50
Network	White Balance	
Multi-Projection	Dynamic Contrast	Off
Memory	Image Enhancement	
Initial/All Settings	Scene Adaptive Gamma	5
	Gamma	0
	RGBCMY	
	Reset to Defaults	
	Source	Computer1
	Resolution	Auto
	Aspect	Auto
	Analog Signal Adjustment	
	Reset to Defaults	

4. Select the **Dynamic Contrast** setting, choose one of the following options, and press **↵ Enter**:
 - **Normal** to adjust brightness at the standard speed.
 - **High Speed** to adjust brightness as soon as the scene changes.
5. Press **Menu** or **Esc** to exit the menus.

Parent topic: [Using Basic Projector Features](#)

Adjusting the Image Resolution

You can adjust the image resolution to project a clear image with an emphatic texture and material feel.

1. Turn on the projector and switch to the image source you want to use.
2. Press the **Menu** button.
3. Select the **Image** menu and press **↵ Enter**.

Frequently Used Items	Image	
Image	Color Mode	Presentation
Signal I/O	Brightness	50
Installation	Contrast	50
Display	Color Saturation	50
Operation	Tint	50
Management	Sharpness	50
Network	White Balance	
Multi-Projection	Dynamic Contrast	Off
Memory	Image Enhancement	
Initial/All Settings	Scene Adaptive Gamma	5
	Gamma	0
	RGBCMY	
	Reset to Defaults	
	Source	Computer1
	Resolution	Auto
	Aspect	Auto
	Analog Signal Adjustment	
	Reset to Defaults	

4. Select **Image Enhancement** and press **↵ Enter**.
5. Select **Image Preset Mode** and press **↵ Enter**.
6. Select the preset option and press **↵ Enter**.

Note: The following settings saved in the preset option are applied to the image:

- **Noise Reduction**
- **MPEG Noise Reduction**
- **Deinterlacing**
- **Super-resolution**
- **Detail Enhancement**

7. Adjust each setting in the projector's Image menu individually as necessary.
 - Adjust the **Noise Reduction** setting to reduce flickering in images.
 - Adjust the **MPEG Noise Reduction** setting to reduce the noise or artifacts seen in MPEG video.
 - Adjust the **Deinterlacing** setting to convert interlaced-to-progressive signals for certain video image types (only displayed when the current signal is interlaced [480i/576i/1080i]).
 - Adjust the **Super-resolution** setting to reduce blurring when projecting low-resolution images.
 - Adjust the **Detail Enhancement** setting to create a more emphatic texture and material feel of the image.

The setting values in the preset option are overwritten as you make changes.

8. Press **Menu** or **Esc** to exit the menus.

Parent topic: [Using Basic Projector Features](#)

Adjusting the Projector's Brightness Level

You can adjust the brightness of your projector's light source.

1. Turn on the projector and switch to the image source you want to use.
2. Press the **Menu** button.

3. Select the **Operation** menu and press **↵ Enter**.

Frequently Used Items	Operation	
Image	Auto Source Search	On
Signal I/O	Light Source Brightness Cont...	
Installation	Direct Power On	Off
Display	Auto Power On	Off
Operation	Sleep Mode	On ^
Management	Sleep Mode Timer	10 min.
Network	A/V Mute Timer	On
Multi-Projection	Standby Mode	Communication On
Memory	Port	Wired LAN
Initial/All Settings	Quick Startup	Off
	USB Power	On While Projecting
	Indicators	On
	Beep	On
	Release A/V Mute	
	Inv Direction Button	Off
	Content Playback	Off v
	Reset Operation Settings	
	Management	

4. Select **Light Source Brightness Control** and press **↵ Enter**.

[Light Source Brightness Control]	Return
Maintain Brightness	On
Maintain Brightness Level	100 %
Estimated Remains	0H []
Light Source Mode	Normal
Brightness Level	100 %

5. If you want to maintain the brightness at a specific level, select the **Maintain Brightness** setting and select **On**.

6. If you turn on **Maintain Brightness**, select the **Maintain Brightness Level** setting and check the **Estimated Remains** information.
7. If you turn off **Maintain Brightness**, select the **Light Source Mode** setting:
 - **Normal**: Sets brightness to the maximum level (ideal for conference rooms, auditoriums, and lecture halls)
 - **Quiet**: Sets brightness to 70% and reduces fan noise (ideal for libraries, theaters, museums, and art galleries)
 - **Extended**: Sets brightness to 70% and extends the life expectancy of the light source (ideal for darker environments with ambient light, such as museums and art galleries, where a reduced maintenance cycle is desired)
 - **Custom**: Allows you to select a custom brightness level between 70 to 100%
8. If you set the **Light Source Mode** setting to **Custom**, select **Brightness Level** and use the left and right arrow buttons to select the brightness.
9. Press **Menu** or **Esc** to exit the menus.

Note: For the best results in maintaining the brightness level, set the **Light Source Calibration** setting to **Run Periodically** in the projector's Management menu.

[Constant Brightness Usage Hours](#)

Parent topic: [Using Basic Projector Features](#)

Related references

[Feature Settings - Operation Menu](#)

Related tasks

[Running Light Source Calibration](#)

Related topics

[Scheduling Projector Events](#)

Constant Brightness Usage Hours

If you turn on the **Maintain Brightness** setting, the number of hours the projector can maintain constant brightness is displayed as the **Estimated Remains** setting.

[Light Source Brightness Control]		Return
Maintain Brightness	On	
Maintain Brightness Level	100 %	
Estimated Remains	0H	
Light Source Mode	Normal	
Brightness Level	100 %	

Display level	Estimated remaining hours
	10000 or more hours
█	8000 to 9999 hours
██	6000 to 7999 hours
███	4000 to 5999 hours
████	2000 to 3999 hours
█████	0 to 1999 hours

Light source life span

The estimated life span of the light source varies depending on the **Brightness Level** setting and whether the **Maintain Brightness** setting is on or off.

Maintain Brightness off

Brightness Level setting	Hours
100%	20000 hours
90%	21000 hours
80%	24000 hours

Brightness Level setting	Hours
70%	30000 hours

Maintain Brightness on

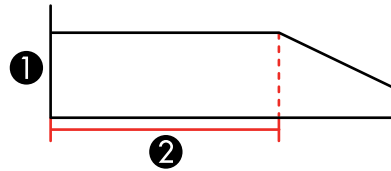

- 1 Brightness level
- 2 Time the projector can maintain constant brightness (approximate)

Brightness Level setting	Hours
85%	6000 hours
80%	10000 hours
75%	14000 hours
70%	19000 hours

Note: The light source usage hours vary depending upon environmental conditions and usage. The hours listed here are an approximate and are not guaranteed. You may need to replace internal parts sooner than the estimated light source operation time. If **Maintain Brightness** is turned on, and you have exceeded the usage hours listed here, you may not be able to select a high **Maintain Brightness Level** setting.

Parent topic: [Adjusting the Projector's Brightness Level](#)

Controlling the Volume with the Volume Buttons

You can use the **Volume** buttons on the remote control to adjust the volume as you project a presentation with audio. The volume buttons control the projector's internal speaker system or any external speakers you connected to the projector.

You must adjust the volume separately for each connected input source.

Warning: Do not start playback at a high volume. Sudden loud noises may cause hearing loss. Always lower the volume before turning off the projector. Gradually increase the volume after turning the projector on.

1. Turn on the projector and start a presentation that includes audio.
2. To lower or raise the volume, press the **Volume** buttons on the remote control.

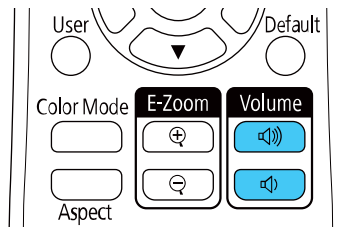

A volume gauge appears on the screen.

3. To set the volume to a specific level for an input source, use the projector menus.

Parent topic: [Using Basic Projector Features](#)

Related references

[Input Signal Settings - Signal I/O Menu](#)

Projecting a PC Free Presentation

You can use your projector's PC Free feature whenever you connect a USB device that contains compatible files. This lets you quickly and easily display the contents of the files and control their display using the projector's remote control.

Note: Make sure **Content Playback** is disabled in the projector's Operation menu.

[PC Free Precautions](#)

[Supported PC Free File Types](#)

[Starting a PC Free Slideshow](#)

[Starting a PC Free Movie Presentation](#)

[PC Free Display Options](#)

Parent topic: [Using Basic Projector Features](#)

Related tasks

[Connecting to a USB Device](#)

PC Free Precautions

Note the following precautions when using PC Free features:

- You cannot use a USB key for quick wireless connection for PC Free features.
- Do not disconnect the USB device while it is being accessed; otherwise, PC Free may not operate correctly.
- You may not be able to use the security features on certain USB devices with PC Free features.
- When connecting a USB device that includes an AC adapter, connect the AC adapter to an electrical outlet when you use the USB device with your projector.
- Some commercially available USB card readers may not be compatible with your projector.
- The projector can recognize up to five cards inserted into a connected card reader at a time.
- You cannot correct keystone distortion while projecting in PC Free, so correct the image shape before you begin your presentation.
- You can use the following features while projecting in PC Free:
 - Freeze
 - A/V Mute
 - E-Zoom

Parent topic: [Projecting a PC Free Presentation](#)

Supported PC Free File Types

You can project these types of files using the projector's PC Free feature.

Note: For best results, place your files on media that is formatted in FAT16/32. If you have trouble projecting from media formatted for non-Windows file systems, try formatting the media for Windows instead. You may not be able to use the security features on certain USB storage devices with PC Free features. When connecting a USB-compatible hard drive, connect the AC adapter supplied with the drive. PC Free may not work with USB device security features.

File type and extension	Details
Image (.jpg)	Make sure the file is not: <ul style="list-style-type: none"> • CMYK format • Progressive format • Highly compressed • Above 8192 × 8192 resolution
Image (.bmp)	Make sure the file resolution is not above 1280 × 800
Image (.gif)	Make sure the file is not: <ul style="list-style-type: none"> • Above 1280 × 800 resolution • Animated • Interlaced
Image (.png)	Make sure the file resolution is not: <ul style="list-style-type: none"> • Above 1920 × 1200 • Interlaced
Motion JPEG movie (.avi)	Supports only AVI 1.0 Make sure the file is not: <ul style="list-style-type: none"> • Saved with a video codec other than Motion JPEG • Saved with an audio codec other than LPCM or IMA ADPCM • Above 1280 × 720 resolution • Larger than 2GB • Saved with a frame rate higher than 30 fps • Saved with an audio sampling rate other than 11.025 kHz, 16 kHz, 22.05 kHz, 24 kHz, 32 kHz, 44.1, or 48 kHz

File type and extension	Details
H.264, H.265 (.mp4/.mov)	Make sure the file is not: <ul style="list-style-type: none"> • Larger than 2GB • Above 1920 × 1200 resolution • A color format other than YUV420 • Saved with a movie codec other than H.264/MPEG-4 AVC (Baseline Profile, Main Profile, High Profile) or H.265/MPEG-H HEVC (Main Profile) • Saved with a frame rate higher than 30 fps • Saved with an audio codec other than MPEG-2 AAC-LC, MPEG-4 AAC-LC, or LPCM • Saved with an audio sampling rate other than 11.025 kHz, 16 kHz, 22.05 kHz, 24 kHz, 32 kHz, 44.1 kHz, or 48 kHz for LPCM, or 44.1 kHz or 48 kHz for MPEG-2 AAC-LC and MPEG-4 AAC-LC • Saved with audio other than 8-bit or 16-bit and up to 2 channels

Parent topic: [Projecting a PC Free Presentation](#)

Starting a PC Free Slideshow

After connecting a USB device or digital camera to the projector, you can switch to the USB input source and start your slideshow.

Note: You can change the slideshow operation options or add special effects by highlighting **Option** at the bottom of the screen and pressing **↩ Enter**.

Note: Make sure **Content Playback** is disabled in the projector's Operation menu.

1. Press the **USB** button on the projector remote control until the PC Free file list appears.

The PC Free screen appears.



2. Do the following as necessary to locate your files:
 - If you need to display files inside a subfolder on your device, press the arrow buttons to highlight the folder and press **↵ Enter**.
 - To move back up a folder level on your device, highlight **Back to Top** and press **↵ Enter**.
 - To view additional files in a folder, highlight **Next page** or **Previous page** and press **↵ Enter**.
 - To display images from a different USB drive, select **Select Drive** at the top of the PC Free screen and press **↵ Enter**.
3. Do one of the following:
 - To display an individual image, press the arrow buttons to highlight the image and press **↵ Enter**. (Press the **Esc** button to return to the file list screen.)
 - To display a slide show of all the images in a folder, press the arrow buttons to highlight the **Slideshow** option at the bottom of the screen and press **↵ Enter**.

Note: If any file names are longer than the display area or include unsupported symbols, the file names may be shortened or changed only in the screen display.

4. While projecting, use the following commands to control the display as necessary:
 - To rotate a displayed image, press the up or down arrow button.
 - To move to the next or previous image, press the left or right arrow button.
5. To stop the display, follow the on-screen instructions or press the **Esc** button.
6. Turn off the USB device, if necessary, and then disconnect the device from the projector.

Parent topic: [Projecting a PC Free Presentation](#)

Related tasks

[Connecting to a USB Device](#)

Starting a PC Free Movie Presentation

After connecting a USB device or digital camera to the projector, you can switch to the USB input source and start your movie.

Note: You can change the operation options by highlighting **Option** at the bottom of the screen and pressing **Enter**.

1. Press the **USB** button on the projector remote control until the PC Free screen appears.

The PC Free screen appears.



2. Do the following as necessary to locate your files:
 - If you need to display files inside a subfolder on your device, press the arrow buttons to highlight the folder and press **Enter**.
 - To move back up a folder level on your device, highlight **Back to Top** and press **Enter**.
 - To view additional files in a folder, highlight **Next page** or **Previous page** and press **Enter**.
 - To display movie files from a different USB drive, select **Select Drive** at the top of the PC Free screen and press **Enter**.
3. To play back a movie, press the arrow buttons to highlight the file and press **Enter**.

Note: If any file names are longer than the display area or include unsupported symbols, the file names may be shortened or changed only in the screen display. If you want to play back all the movies in a folder in sequence, select the **Slideshow** option at the bottom of the screen.
4. To stop movie playback, press the **Esc** button, highlight **Exit**, and press **Enter**.
5. Turn off the USB device, if necessary, and then disconnect the device from the projector.

Parent topic: [Projecting a PC Free Presentation](#)

Related tasks

[Connecting to a USB Device](#)

PC Free Display Options

You can select these display options when using the projector's PC Free feature.

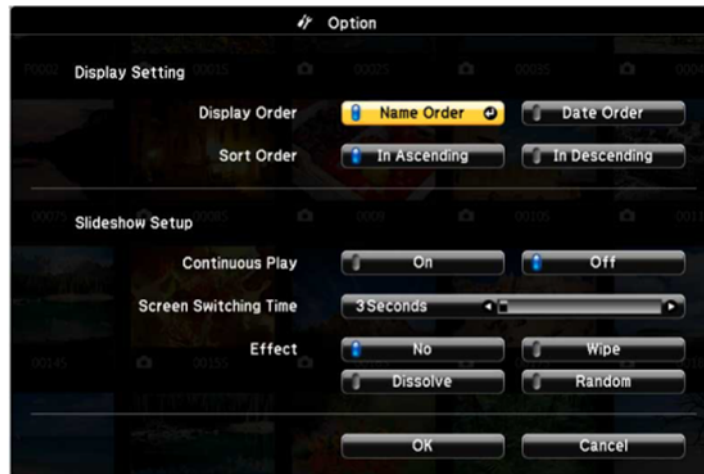

Setting	Options	Description
Display Order	Name Order	Displays files in name order
	Date Order	Displays files in date order
Sort Order	In Ascending	Sorts files in first-to-last order
	In Descending	Sorts files in last-to-first order
Continuous Play	On	Displays a slideshow continuously
	Off	Displays a slideshow one time through

Setting	Options	Description
Screen Switching Time	No	Does not display the next file automatically
	1 Second to 60 Seconds	Displays files for the selected time and switches to the next file automatically; high resolution images may switch at a slightly slower rate
Effect	No	No effect
	Wipe	Transitions between images with a wipe effect
	Dissolve	Transitions between images with a dissolve effect
	Random	Transitions between images using a random variety of effects

Parent topic: [Projecting a PC Free Presentation](#)

Projecting in Content Playback Mode

You can project images or other content from an external storage device using Content Playback mode. You can also add color or effects to the projected image.

[Switching to Content Playback Mode](#)

[Projecting a Playlist in Content Playback Mode](#)

[Creating a Playlist Using Epson Web Control](#)

[Adding Effects to the Projected Image](#)

Parent topic: [Using Basic Projector Features](#)

Related tasks

[Connecting to a USB Device](#)

Switching to Content Playback Mode

Make sure Content Playback mode is enabled before projecting images or playlists.

1. Turn on the projector.
2. Press the **Menu** button.

3. Select the **Operation** menu and press **Enter**.

Frequently Used Items	Operation	
Image	Auto Source Search	On
Signal I/O	Light Source Brightness Cont...	
Installation	Direct Power On	Off
Display	Auto Power On	Off
Operation	Sleep Mode	On ^
Management	Sleep Mode Timer	10 min.
Network	A/V Mute Timer	On
Multi-Projection	Standby Mode	Communication On
Memory	Port	Wired LAN
Initial/All Settings	Quick Startup	Off
	USB Power	On While Projecting
	Indicators	On
	Beep	On
	Release A/V Mute	
	Inv Direction Button	Off
	Content Playback	Off v
	Reset Operation Settings	
	Management	

4. Select **Content Playback** and press **Enter**.
5. Select **On**, if necessary, and press **Enter**.
You see a confirmation prompt.
6. Turn off the projector.
7. Turn on the projector again to enable Content Playback mode.
You can press the **Home** button to make sure Content Playback mode is enabled.

Note: You cannot perform the following operations in Content Playback mode:

- Color Temp. (when **Warm White** or **Cool White** is selected as **Color Filter**)
- Blanking
- Split Screen
- Log Save Destination
- Screen Type

- No-signal Screen
- Detecting the input signal automatically
- Remote Password
- PC Free
- Document camera
- Screen delivery function using the Epson iProjection software
- Connection Guide Display

Parent topic: [Projecting in Content Playback Mode](#)

Related references

[Installation Settings - Installation Menu](#)

Related tasks

[Setting the Screen Type](#)

Projecting a Playlist in Content Playback Mode

You can project playlists that contain images and movies in Content Playback mode.

1. Create a playlist and export it to a USB device using the Epson Projector Content Manager software.

Note: See the *Epson Projector Content Manager Operation Guide* for more information.

2. Turn on the projector.
3. Insert the USB device containing the playlist to the projector's **USB-A** port.
4. Press the **USB** button on the remote control to project the playlist.

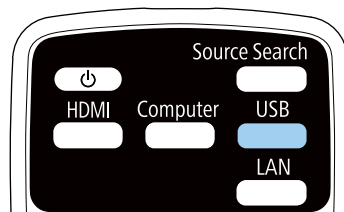

The playlist that was played last is projected. If a timetable is assigned, the playlist will play back according to the schedule in the timetable.

Note: You can also hold down the **Num** and numeric buttons to project your playlist. You can set a remote control shortcut key using the software you used to create the playlists.

Note: To select a specific playlist, select the **USB Viewer** setting in the Operation menu and use the arrow buttons to select your playlist.

Parent topic: [Projecting in Content Playback Mode](#)

Related references

[Feature Settings - Operation Menu](#)

[Additional Projector Software and Manuals](#)

Related tasks

[Controlling a Networked Projector Using a Web Browser](#)

[Connecting to a USB Device](#)

Creating a Playlist Using Epson Web Control

You can create playlists using a web browser and save them to a USB flash drive connected to a projector on a network when the projector is in Content Playback mode.

Caution: Do not remove the USB flash drive from the projector or disconnect the projector's power cord while creating playlists. Data saved on the USB flash drive may be damaged.

1. Make sure the projector is in Content Playback mode.
2. Make sure your computer or device is connected to the same network as the projector.
3. Connect a USB device to the projector's **USB-A** port.
4. Start your web browser on your computer or device.
5. Enter the projector's IP address into the browser's address box and press the computer's **Enter** key.

Note: When entering an IPv6 address, wrap the address with [and].

Note: If you see a log in window, enter your user name and password. (The default user name is **EPSONWEB** and the default password is **admin**.)

You see the Epson Web Control screen.

6. Select **USB Memory Device**.
7. Select **Upload New Data**.
8. Select the images or movies you want to add to the playlist.

Note: You cannot upload .mp4 or .mov files. If you want to add .mp4 or .mov files to the playlist, use Epson Projector Content Manager software or the Epson Creative Projection app.

The selected files are copied to the USB device that is connected to the projector.

9. Do one of the following:
 - Select **Create New Playlist** to create a new playlist and add the files to it.
 - Select **Add to Playlist** and select the existing playlist you want to add the files to.
10. Edit the playlist.
11. Select **Finish** when you are done editing the playlist.

You can play the playlist from the Remote or Playlist screen. If you want to specify when the playlist starts and finishes, schedule the playlist using the Epson Projector Content Manager software. See the *Epson Projector Content Manager Operation Guide* for details.

Parent topic: [Projecting in Content Playback Mode](#)

Related tasks

[Controlling a Networked Projector Using a Web Browser](#)

Adding Effects to the Projected Image

You can add color and effects to the projected image in Content Playback mode.

Note: When you use the effects feature, select **Refresh Mode > Start** on the **Management** menu periodically. This feature is not available when using the **Edge Blending** feature.

1. Press the **Menu** button on the remote control.
2. Select the **Operation** menu.

3. Select the **Overlay Effect** setting and set it to **On**.

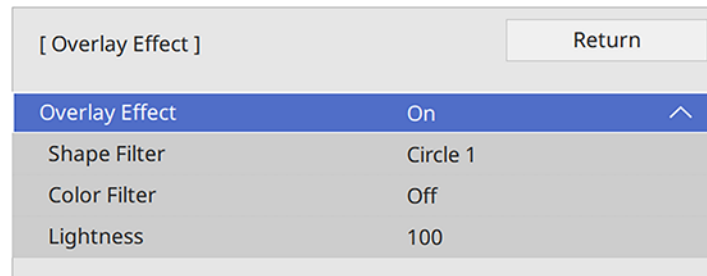

4. Select the **Shape Filter** setting and adjust the options as necessary.

- **Shape:** select a circle, rectangle, or other shape effect

Note: You can add your images as customized shapes using the Epson Projector Content Manager software. See the *Epson Projector Content Manager Operation Guide* for details.

- **Filter Effect:** select an option to mask the inside or outside of the shape
- **Size:** set the shape size
- **Position:** set the shape position

Note: When you use a customized shape, you cannot change the **Size** and **Position** settings.

5. Select the **Color Filter** setting and adjust the options as necessary.

- **Color Filter:** select the color
- **Custom:** adjust red, green, or blue individually

6. Select the **Lightness** setting and adjust the brightness level.

7. Press the **Menu** button to exit.

Parent topic: [Projecting in Content Playback Mode](#)

Related references

[Feature Settings - Operation Menu](#)

Adjusting Projector Features

Follow the instructions in these sections to use your projector's feature adjustments.

[Shutting Off the Picture and Sound Temporarily](#)

[Stopping Video Action Temporarily](#)

[Zooming Into and Out of Images](#)

[Projector Security Features](#)

[Projecting Multiple Images Simultaneously](#)

[Using Multiple Projectors](#)

[Saving Settings to Memory and Using Saved Settings](#)

[Adjusting the Color Tone \(Color Uniformity\)](#)

[Running Light Source Calibration](#)

[Scheduling Projector Events](#)

[Copying Menu Settings Between Projectors](#)

Shutting Off the Picture and Sound Temporarily

You can temporarily turn off the projected picture and sound if you want to redirect your audience's attention during a presentation. Any sound or video action continues to run, however, so you cannot resume projection at the point that you stopped it.

Note: If the picture and sound are off for more than 30 minutes, the power automatically turns off. You can turn the **A/V Mute Timer** setting on and off in the projector's Operation menu.

1. Press the **A/V Mute** button on the remote control to temporarily stop projection and mute any sound.

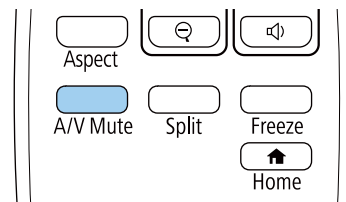

2. To turn the picture and sound back on, press the **A/V Mute** button again.

Note: You can also stop projection using the **A/V Mute** button on the projector.

Note: If you selected **A/V Mute** as the **Release A/V Mute** setting in the Operation menu, you can still control the projector while A/V Mute is enabled.

Parent topic: [Adjusting Projector Features](#)

Related references

[Feature Settings - Operation Menu](#)

Stopping Video Action Temporarily

You can temporarily stop the action in a video or computer presentation and keep the current image on the screen. Any sound or video action continues to run, however, so you cannot resume projection at the point that you stopped it.

1. Press the **Freeze** button on the remote control to stop the video action.

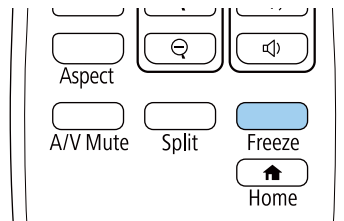

2. To restart the video action in progress, press **Freeze** again.

Parent topic: [Adjusting Projector Features](#)

Zooming Into and Out of Images

You can draw attention to parts of a presentation by zooming into a portion of the image and enlarging it on the screen.

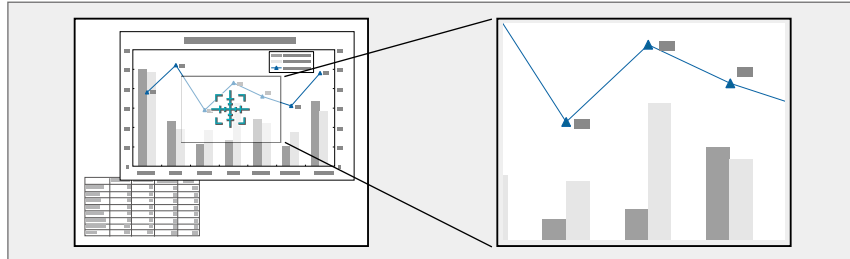

Note: This feature is unavailable if the **Scale** setting in the Image menu is enabled.

1. Press the **E-Zoom +** button on the remote control.

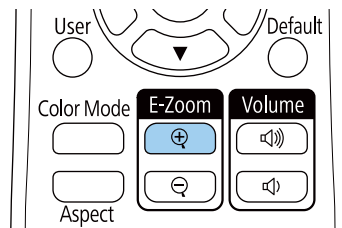

Depending on your model, you either see a crosshair on the screen indicating the center of the zoom area (PowerLite EB-L530U/EB-L630U/EB-L630SU/EB-L635SU/EB-L730U/EB-L735U) or the center of the projected image is enlarged (PowerLite EB-L520U).

2. Use the following buttons on the remote control to adjust the zoomed image:
 - Use the arrow buttons to position the image area you want to zoom into.
 - Press the **E-Zoom +** button repeatedly to zoom into the image area, enlarging it as necessary.
 - To pan around the zoomed image area, use the arrow buttons.
 - To zoom out of the image, press the **E-Zoom –** button as necessary.
 - To return to the original image size, press the **Default** button (PowerLite EB-L520U).

Parent topic: [Adjusting Projector Features](#)

Related references

[Image Quality Settings - Image Menu](#)

Projector Security Features

You can secure your projector to deter theft or prevent unintended use by setting up the following security features:

- Password security to prevent the projector from being turned on, and prevent changes to the startup screen and other settings.
- Button lock security to block operation of the projector using the buttons on the control panel.
- Security cabling to physically cable the projector in place.

[Password Security Types](#)

[Locking the Projector's Buttons](#)

[Locking the Remote Control Buttons](#)

[Installing a Security Cable](#)

Parent topic: [Adjusting Projector Features](#)

Password Security Types

You can set up these types of password security using one shared password:

- **Power On Protection** password prevents anyone from using the projector without first entering a password.
- **User's Logo** password prevents anyone from changing the custom screen the projector can display when it turns on. The presence of the custom screen discourages theft by identifying the projector's owner.
- **Network** password prevents anyone from changing the network settings in the projector menus.
- **Schedule** password prevents anyone from changing the projector's time or schedule settings.

[Setting a Password](#)

[Selecting Password Security Types](#)

[Entering a Password to Use the Projector](#)

[Saving a User's Logo Image to Display](#)

Parent topic: [Projector Security Features](#)

Setting a Password

To use password security, you must set a password.

Note: The default password is set to **0000**.

1. Hold down the **Freeze** button on the remote control for about 5 seconds or until you see this menu.

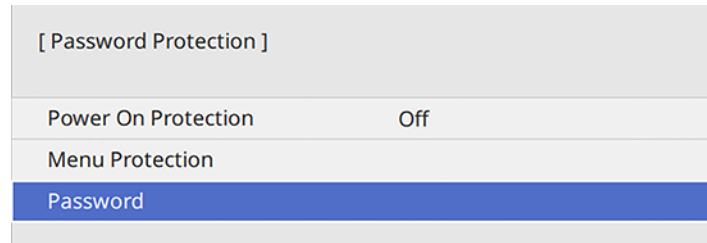

2. Press the down arrow to select **Password** and press **Enter**.
You see the prompt "Change the password?".
3. Select **Yes** and press **Enter**.
4. Press and hold down the **Num** button on the remote control and use the numeric buttons to set a four-digit password.

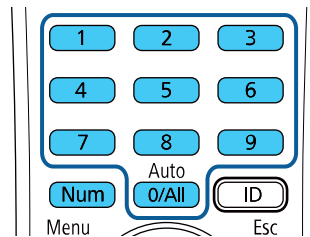

The password displays as **** as you enter it. Then you see the confirmation prompt.

5. Enter the password again.
You see the message "Password accepted."
6. Press **Esc** to return to the menu.
7. Make a note of the password and keep it in a safe place in case you forget it.

Parent topic: [Password Security Types](#)

Selecting Password Security Types

After setting a password, you see this menu, allowing you to select the password security types you want to use.

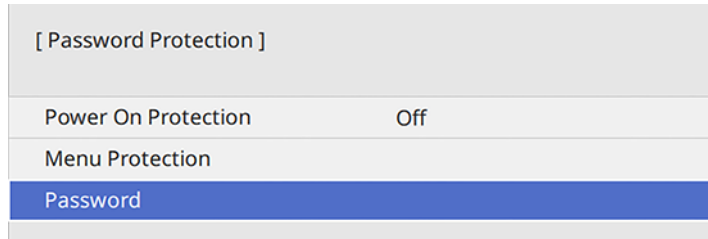

If you do not see this menu, hold down the **Freeze** button on the remote control for about five seconds or until the menu appears.

- To prevent unauthorized use of the projector, select **Power On Protection**, press **↵ Enter**, select **On**, press **↵ Enter** again, and press **Esc**.
- To prevent changes to certain projector settings, select **Menu Protection**, press **↵ Enter**, and do the following as necessary:
 - To prevent changes to the User's Logo screen or related display settings, select **User's Logo**, press **↵ Enter**, select **On**, press **↵ Enter** again, and press **Esc**.
 - To prevent changes to the projector's time or schedule settings, select **Schedule**, press **↵ Enter**, select **On**, press **↵ Enter** again, and press **Esc**.
 - To prevent changes to network settings, select **Network**, press **↵ Enter**, select **On**, press **↵ Enter** again, and press **Esc**.

You can attach the Password Protect sticker to the projector as an additional theft deterrent.

Note: Be sure to keep the remote control in a safe place; if you lose it, you will not be able to enter the password required to use the projector.

Parent topic: [Password Security Types](#)

Entering a Password to Use the Projector

If a password is set up and a **Power On Protection** password is enabled, you see a prompt to enter a password whenever you turn on the projector.

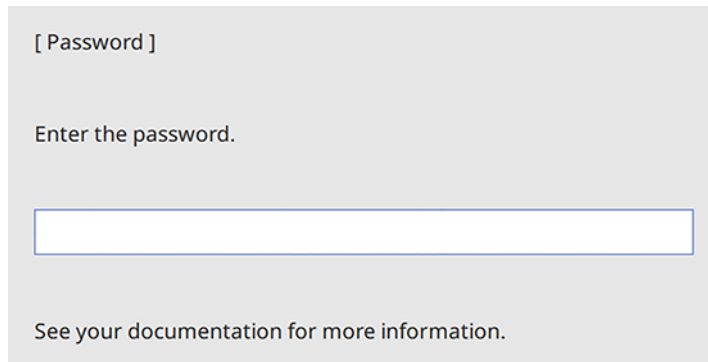

You must enter the correct password to use the projector.

1. Press and hold down the **Num** button on the remote control while you enter the password using the numeric buttons.

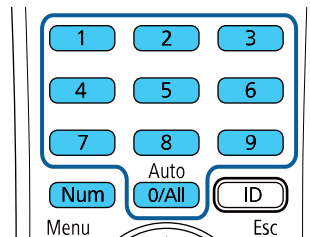

Note: The default password is **0000**.

The password screen closes.

2. If the password is incorrect, the following may happen:
 - You see a "wrong password" message and a prompt to try again. Enter the correct password to proceed.
 - If you have forgotten the password, make note of the **Request Code: xxxxx** number that appears on the screen and contact Epson Support.

- If you enter an incorrect password three times in succession, you see a message telling you that the projector is locked. After the message is displayed for 5 minutes, the projector enters standby mode. Unplug the projector, plug in the power cord, and turn on the projector. You see a prompt to enter the password.
- If you continue to enter an incorrect password many times in succession, the projector displays a request code and a message to contact Epson Support. Do not attempt to enter the password again. When you contact Epson Support, provide the displayed request code and proof of ownership for assistance in unlocking the projector.

Parent topic: [Password Security Types](#)

Related references

[Where to Get Help \(U.S. and Canada\)](#)

[Where to Get Help \(Latin America\)](#)

Saving a User's Logo Image to Display

You can transfer an image to the projector and then display it whenever the projector turns on. You can also display the image when the projector is not receiving an input signal or when you temporarily stop projection. This transferred image is called the User's Logo screen.

The image you select as the User's Logo can be a photo, graphic, or company logo, which is useful in identifying the projector's owner to help deter theft. You can prevent changes to the User's Logo by setting up password protection for it.

Note: You cannot save an image that is protected by HDCP as a User's Logo. You cannot display a user's logo when **Content Playback** is set to **On**. If you turned on password protection for the User's Logo, turn it off before performing these steps.

Note: When you copy the menu settings from one projector to another using the batch setup feature, the user logo is also copied. Do not include any information in the user logo that you do not want to share between multiple projectors.

1. Display the image you want to project as the User's Logo.

2. Press the **Menu** button, select the **Management** menu, and press **↵ Enter**.

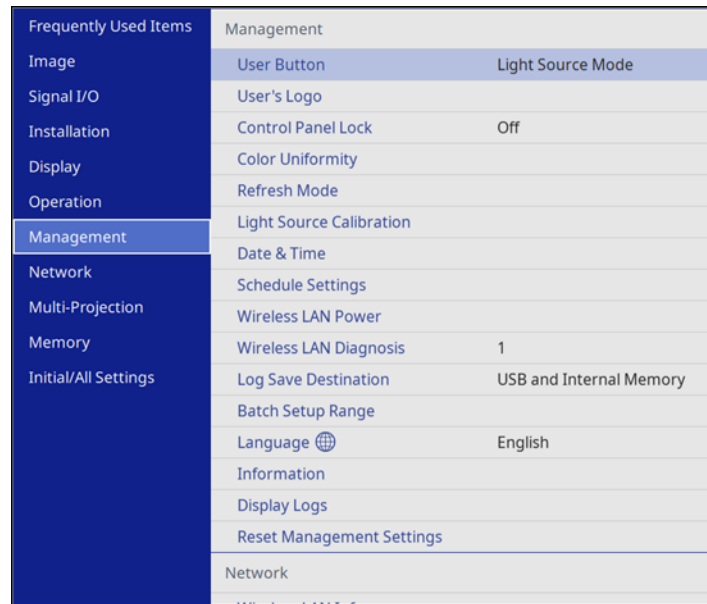

The screenshot shows a settings menu with a dark blue sidebar on the left and a light gray main area on the right. The sidebar lists various categories: Frequently Used Items, Image, Signal I/O, Installation, Display, Operation, Management (highlighted), Network, Multi-Projection, Memory, and Initial/All Settings. The main area displays the Management menu items: User Button (with Light Source Mode), User's Logo, Control Panel Lock (Off), Color Uniformity, Refresh Mode, Light Source Calibration, Date & Time, Schedule Settings, Wireless LAN Power, Wireless LAN Diagnosis (1), Log Save Destination (USB and Internal Memory), Batch Setup Range, Language (English), Information, Display Logs, and Reset Management Settings. A Network option is visible at the bottom of the main area.

Frequently Used Items	Management
Image	User Button Light Source Mode
Signal I/O	User's Logo
Installation	Control Panel Lock Off
Display	Color Uniformity
Operation	Refresh Mode
Management	Light Source Calibration
Network	Date & Time
Multi-Projection	Schedule Settings
Memory	Wireless LAN Power
Initial/All Settings	Wireless LAN Diagnosis 1
	Log Save Destination USB and Internal Memory
	Batch Setup Range
	Language English
	Information
	Display Logs
	Reset Management Settings
	Network

3. Select the **User's Logo** setting and press **↵ Enter**.

4. Select **Start Setting** and press **↵ Enter**.

You see a prompt asking if you want to use the displayed image as a user's logo.

Note: When you select **User's Logo**, adjustments such as **Geometry Correction**, **E-Zoom**, **Aspect**, **Scale**, and **Screen Type** are temporarily canceled.

5. Select **Yes** and press **↵ Enter**.

Note: Depending on the image signal, the screen size may change to match the resolution of the image signal.

6. Make sure the image appears as you want it, then select **Yes** again and press **↵ Enter**.

You see a completion message.

7. Press **Esc** to exit the message screen.

8. Select the **Display** menu and press **↵ Enter**.
9. Select when you want to display the User's Logo screen:
 - To display it whenever there is no input signal, select **No-Signal Screen** and set it to **Logo**.
 - To display it whenever you turn the projector on, select **Startup Screen** and set it to **On**.

To prevent anyone from changing the User's Logo settings without first entering a password, set a password and enable User's Logo security.

Parent topic: [Password Security Types](#)

Related references

[Administration Settings - Management Menu](#)

Related tasks

[Switching to Content Playback Mode](#)

[Setting a Password](#)

[Selecting Password Security Types](#)

Locking the Projector's Buttons

You can lock the buttons on the projector's control panel to prevent anyone from using the projector. You can lock all the buttons or all the buttons except the power button.

Note: The projector can still be operated using the remote control.

1. Press the **Menu** button.

2. Select the **Management** menu and press **↵ Enter**.

Frequently Used Items	Management
Image	User Button Light Source Mode
Signal I/O	User's Logo
Installation	Control Panel Lock Off
Display	Color Uniformity
Operation	Refresh Mode
Management	Light Source Calibration
Network	Date & Time
Multi-Projection	Schedule Settings
Memory	Wireless LAN Power
Initial/All Settings	Wireless LAN Diagnosis 1
	Log Save Destination USB and Internal Memory
	Batch Setup Range
	Language 🌐 English
	Information
	Display Logs
	Reset Management Settings
	Network

3. Select the **Control Panel Lock** setting and press **↵ Enter**.
4. Select one of these lock types and press **↵ Enter**:
 - To lock all of the projector's buttons, select **Full Lock**.
 - To lock all buttons except the power button, select **Except for Power**.

You see a confirmation prompt.

5. Select **Yes** and press **↵ Enter**.

[Unlocking the Projector's Buttons](#)

Parent topic: [Projector Security Features](#)

Unlocking the Projector's Buttons

If the projector's buttons have been locked, hold the **↵ Enter** button on the projector's control panel for 7 seconds to unlock them. You can also set the **Control Panel Lock** setting to **Off** in the Management menu.

Parent topic: [Locking the Projector's Buttons](#)

Locking the Remote Control Buttons

You can lock some of the buttons on the remote control.

To lock the remote control buttons shown here, press and hold the **Home** button on the remote control for approximately 5 seconds. (To unlock the buttons, press and hold the **Home** button again for approximately 5 seconds.)

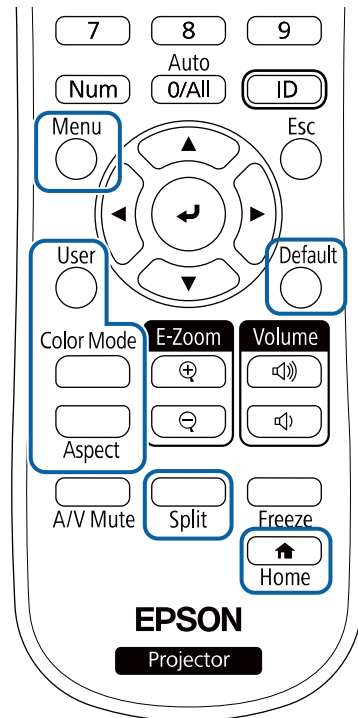

Note: If you lock the remote control buttons, you can still reset the **Remote Receiver** setting in the Installation menu to the default settings.

Parent topic: [Projector Security Features](#)

Related references

[Installation Settings - Installation Menu](#)

[Solutions to Remote Control Problems](#)

Installing a Security Cable

You can install two types of security cables on the projector to deter theft.

- Use the security slot on the projector to attach a Kensington lock. See your local computer or electronics dealer for purchase information.
- Use the security cable attachment point on the projector to attach a wire cable and secure it to a room fixture or heavy furniture.

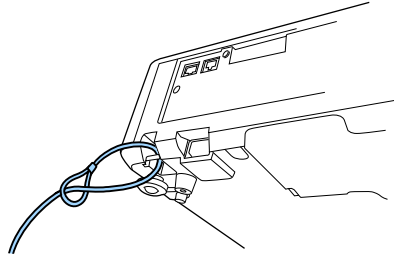

Note: Do not pass drop-prevention cables through the security cable attachment point when mounting the projector on a wall or ceiling.

Parent topic: [Projector Security Features](#)

Projecting Multiple Images Simultaneously

You can use the split screen feature to simultaneously project from two or four images from different image sources next to each other.

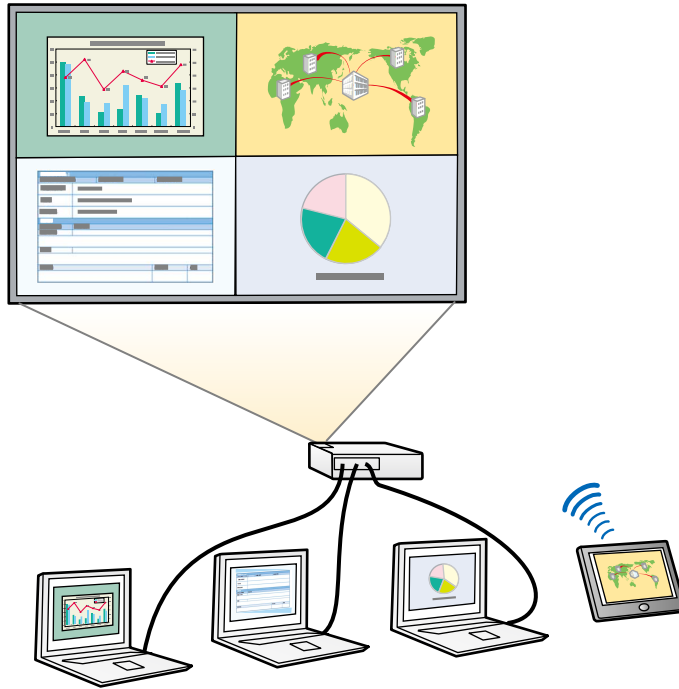

Note: While you use the split screen feature, other projector features may not be available and some settings may be automatically applied to all images.

Note: You cannot use split screen with certain input source combinations.

1. Press the **Split** button on the remote control.

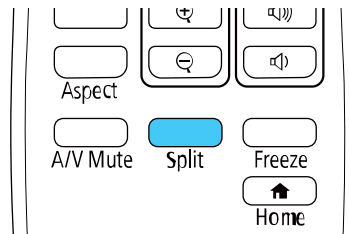

Note: You can also select **Split Screen** from the Home screen.

You are prompted for the number of screens.

2. Select **2 Screens** or **4 Screens**, depending on the number of input sources you want to project.

If you selected **2 Screens**, the currently selected input source moves to the left side of the screen. If you selected **4 Screens** and used the split screen feature to project four images before, the projected images are arranged in the same order as they were previously.

3. Press the **Menu** button.

You see a screen like this:

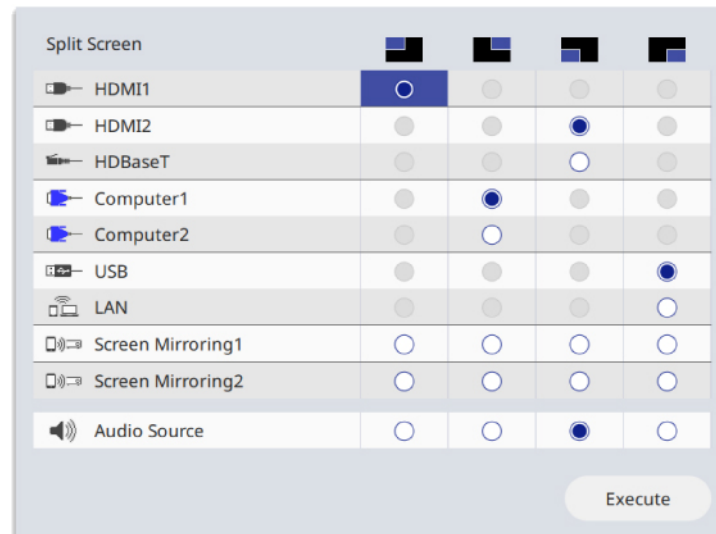

4. Press the arrow and **↵ Enter** buttons to select an image source for each section of the screen.
5. To choose the audio you want to hear, select an input source as the **Audio Source** setting.
6. If you selected **2 Screens** and want to change the size of the images, select a sizing option as the **Screen Size** setting.
7. Select **Execute** and press **↵ Enter**.
8. To exit the split screen feature, press the **Split** or **Esc** button.

[Input Sources for Split Screen Projection](#)

[Split Screen Projection Restrictions](#)

Parent topic: [Adjusting Projector Features](#)

Input Sources for Split Screen Projection

You can choose most input source combinations for split screen projection, but the following combinations are not supported:

- **HDMI2** and **HDBaseT**
- **Computer1** and **Computer2**
- **USB** and **LAN**

Note: When you split the screen into quarters and select the **USB** and **Screen Mirroring** input sources at the same time, you can only select one Screen Mirroring source.

Parent topic: [Projecting Multiple Images Simultaneously](#)

Split Screen Projection Restrictions

You cannot perform the following operations during split screen projection:

- Change settings in the projector's menu
- E-Zoom
- Switching the aspect mode (the aspect mode is set to **Auto**)
- Operations using the **User** button on the remote control, other than displaying the network information on the projected surface
- Applying the **Dynamic Contrast** setting
- Applying the **Image Shift** setting
- Displaying the network information on the projected surface by a method other than pressing the **User** button
- Displaying the Screen Mirroring information bar

Image restrictions

- Even if you set **No-signal screen** to **Logo** in the Display menu, the blue screen appears when no image signal is being input
- When you create a single, unified image projected from multiple projectors and use the split screen feature, the second projector detects no image signal

Parent topic: [Projecting Multiple Images Simultaneously](#)

Using Multiple Projectors

You can combine the projected images from two or more projectors to create one large image. Follow the instructions in these sections to set up and project from multiple projectors.

Note: Wait at least 20 minutes after you start projecting before adjusting the image.

[Multiple Projector Adjustment Overview](#)

[Projector Identification System for Multiple Projector Control](#)

[Configuring Tiling Manually](#)

[Blending the Image Edges](#)

[Adjusting the Black Level](#)

[Matching the Image Colors](#)

[Scaling an Image](#)

Parent topic: [Adjusting Projector Features](#)

Multiple Projector Adjustment Overview

The following steps provide an overview of image adjustment for multiple projectors. You can correct the brightness and color tone of each projector's image and create a seamless image from multiple projectors.

Note the following when using multiple projectors:

- Wait 20 minutes before adjusting the image
 - In some cases the brightness and color tone may not match completely even after adjustment
 - If brightness and color tone differences become more noticeable over time, repeat the adjustments
 - When installing the projectors, make sure hot air from the exhaust vent of one projector does not enter the air intake vent of another projector.
1. Turn on all the projectors.
 2. Set an ID for each projector and the remote control.
 3. Adjust each projector's physical position and angle to the screen.
 4. Adjust the arrangement of the images (tiling).
 5. Adjust the image aspect ratio for each projector.
 6. Adjust the position of the image for each projector using lens shift (not available for the PowerLite EB-L520U).

7. Adjust the zoom and focus for each projector.
8. Adjust small differences in the images using the **Point Correction** setting.
9. Adjust the edges of the images using the **Edge Blending** and **Black Level** settings.
10. Adjust the brightness and tint of the images using the **Color Matching** setting.
11. Crop and combine each projector's image area using the **Scale** setting.

Parent topic: [Using Multiple Projectors](#)

Projector Identification System for Multiple Projector Control

You can operate multiple projectors using one remote control for more elaborate presentations. To do this, you assign an identification number to each projector and to the remote control. Then you can operate all the projectors at once or individually.

Note: To control more than nine projectors, use the Epson Projector Professional Tool.

[Setting the Projector ID](#)

[Setting the Remote Control ID](#)

Parent topic: [Using Multiple Projectors](#)

Setting the Projector ID

If you want to control multiple projectors from a remote control, give each projector a unique ID.

Note: To control more than nine projectors, use the Epson Projector Professional Tool.

1. Press the **Menu** button.
2. Select the **Multi-Projection** menu and press **↵ Enter**.

3. Select **Projector ID** and press **↵ Enter**.

[Projector ID]	Return
✓ Off	
1	
2	
3	
4	
5	
6	
7	
8	
9	

4. Press the arrow buttons on the remote control to select the identification number you want to use for the projector. Then press **↵ Enter**.

Repeat these steps for all the other projectors you want to operate from one remote control.

Note: If you don't know the projector's ID, aim the remote control at the projector and press the **ID** button to temporarily display the projector's ID on the screen.

Parent topic: [Projector Identification System for Multiple Projector Control](#)

Setting the Remote Control ID

The remote control's ID is set to zero by default so it can operate any compatible projector. If you want to set the remote control to operate only a particular projector, you need to set the remote control's ID to match the projector's ID.

1. Turn on the projector you want the remote control to operate with exclusively.
2. Aim the remote control at that projector and press the **ID** button on the remote control.

The current projector ID is displayed on the screen for about 3 seconds.

3. Hold down the **ID** button on the remote control while you press the numeric button that matches the projector's ID. Then release the buttons.

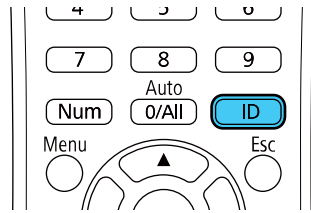

Note: If you select **0/All** on the remote control, you can operate all projectors regardless of the **Projector ID** setting.

The remote control's ID is set.

Note: If the batteries are left out of the remote control for an extended period, the remote control ID returns to its default setting. If you use multiple remote controls at the same time, you may not be able to operate the projectors as intended due to infrared interference.

Parent topic: [Projector Identification System for Multiple Projector Control](#)

Configuring Tiling Manually

You can project the same image from multiple projectors to create one large image. You can configure tiling manually.

1. Turn on the projector.
2. Press the **Menu** button.
3. Select **Multi-Projection > Tiling > Layout**.

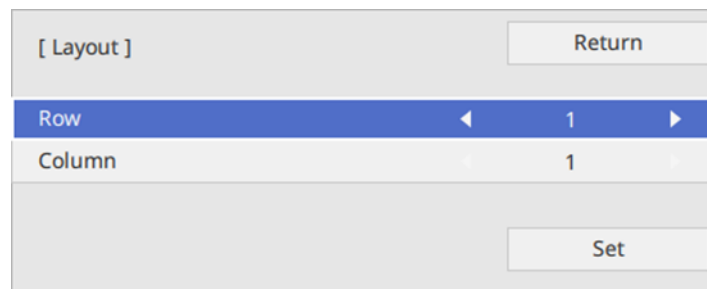

4. Select the number of rows and columns you are setting up as the **Row** and **Column** settings. Then select **Set** and press **↵ Enter**.
5. Repeat the previous steps with each projector you are setting up before continuing with the next step.
6. Select **Location Setup** and press **↵ Enter**.

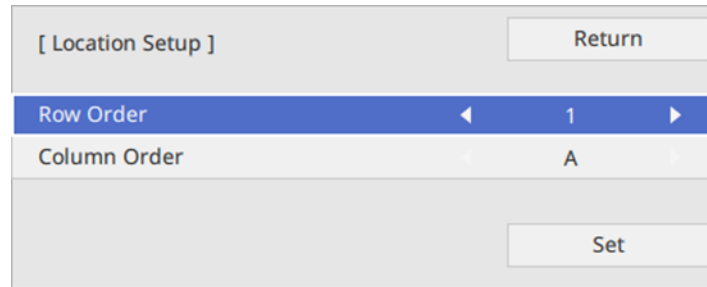

7. Select the position of each projected image as follows:
 - **Row Order** to layout the screens from top to bottom in sequential order, starting with **1** at the top
 - **Column Order** to layout the screens from left to right, starting with **A** on the left

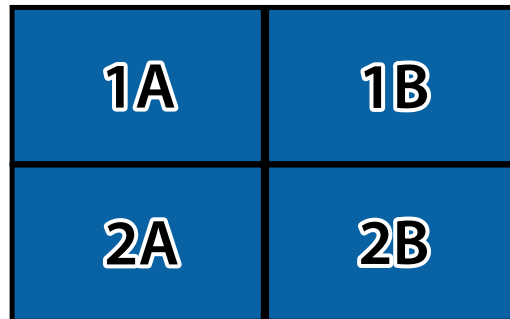

8. Repeat the previous step with each projector you are setting up before continuing with the next step.
9. Select the input signal to display an image.

After performing the steps here, adjust the images for any gaps and differences in color.

Parent topic: [Using Multiple Projectors](#)

Related references

[Multiple Projector Operation Settings - Multi-Projection Menu](#)

Blending the Image Edges

You can use the projector's Edge Blending feature to create a seamless image from multiple projectors.

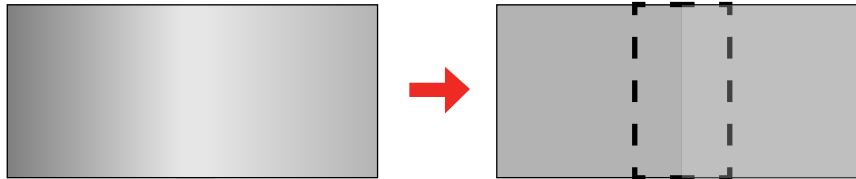

1. Press the **Menu** button.
2. Select the **Multi-Projection** menu and press **↵ Enter**.

Frequently Used Items	Multi-Projection
Image	Projector ID Off
Signal I/O	HDMI Out Setting Off ▼
Installation	Tiling
Display	Geometry Correction Point Correction
Operation	Edge Blending
Management	Scale
Network	Color Uniformity
Multi-Projection	Light Source Mode Normal
Memory	Color Matching
Initial/All Settings	RGBCMY
	Reset Multi-Projection Settings
	Memory
	Save Memory
	Load Memory
	Rename Memory
	Erase Memory
	Reset Memory Settings

3. Select the **Edge Blending** setting and press **↵ Enter**.

4. Turn on the **Edge Blending**, **Line Guide**, and **Pattern Guide** settings.

Note: Select a different **Guide Color** setting for each projector so that you can see the blended area clearly.

5. Select the edge you want to blend on each projector and press **↵ Enter**. For the projector on the left, select the **Right Edge** and for the projector on the right, select **Left Edge**.

You see a screen like this:

[Top Edge]	Return
Blending	Off
Blend Start Position	0
Blend Range	0
Blend Curve	0

6. Select the **Blending** setting and select **On**.
7. Press **Esc** to return to the previous screen.
8. Select the **Blend Start Position** setting and adjust the point where edge blending begins.

Note: If you created a unified image area using the Edge Blending feature, set the **Blend Start Position** setting to **0**.

9. Select the **Blend Range** setting and use the arrow buttons to select the width of the blended area so that the displayed guides are at the edges of the overlapping area between the two images.

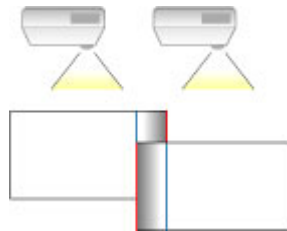

10. Press **Esc** to go back to the previous screen.
11. Select the **Blend Curve** setting and select a gradient for the shaded area on the projectors.
12. When the edges are blended, turn off the **Line Guide** and **Pattern Guide** settings on each projector to check the final settings.
13. When you are finished, press the **Menu** button.

If the blended area does not overlap exactly, correct the shape of the blended area using **Point Correction**.

Parent topic: [Using Multiple Projectors](#)

Related references

[Multiple Projector Operation Settings - Multi-Projection Menu](#)

Related tasks

[Correcting Image Shape with Point Correction](#)

Adjusting the Black Level

When two images overlap, the overlapping area can appear differently from the areas that do not overlap. You can use the projector's Black Level setting to make the difference less noticeable.

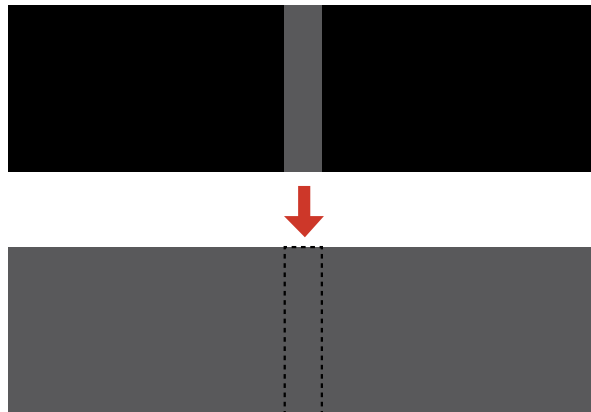

Note: You cannot adjust the black levels while projecting a test pattern, and you may not be able to adjust the black levels correctly if the **Geometry Correction** settings are set too high. The brightness and tone of the overlapping areas may differ from the rest of the image even after adjusting the black level.

1. Press the **Menu** button.
2. Select the **Multi-Projection** menu and press **↵ Enter**.

Frequently Used Items	Multi-Projection
Image	Projector ID Off
Signal I/O	HDMI Out Setting Off
Installation	Tiling
Display	Geometry Correction Point Correction
Operation	Edge Blending
Management	Scale
Network	Color Uniformity
Multi-Projection	Light Source Mode Normal
Memory	Color Matching
Initial/All Settings	RGBCMY
	Reset Multi-Projection Settings
	Memory
	Save Memory
	Load Memory
	Rename Memory
	Erase Memory
	Reset Memory Settings

3. Select the **Black Level** setting and press **↵ Enter**.

Note: The **Black Level** setting is displayed only if **Edge Blending** is enabled and at least one (top, bottom, left, right) edge is set to **On**.

4. Select the **Color Adjustment** setting and press **↵ Enter**.

You see a screen based on the **Top Edge**, **Bottom Edge**, **Right Edge**, and **Left Edge** settings you selected for the **Edge Blending** setting.

5. Select the area you want to adjust and press **↵ Enter**.

Note: The area you selected is displayed in orange. Adjust overlapping areas starting with the brightest areas first. For example, adjust area 2 to match area 1, then adjust area 3 to match area 2.

- Adjust the brightness and tone of the areas that do not overlap to match the areas that overlap using the displayed adjustment sliders. Then press the **Esc** button.

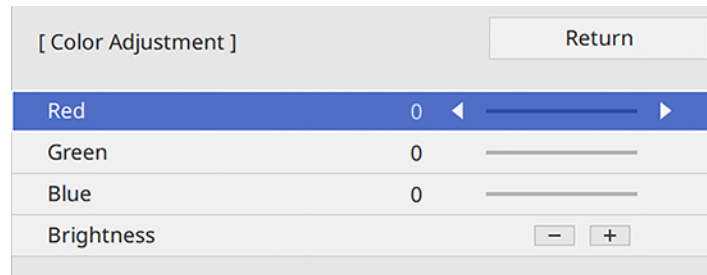

- Repeat the previous two steps as needed until all areas match.
- If the tone of some areas do not match, you can adjust them using the **Area Correction** setting. Continue with the next step. Otherwise, press the **Menu** button to exit.
- Press the **Esc** button to return to the Black Level screen.
- Select the **Area Correction** setting and press **↵ Enter**.
- Select the **Start Adjustments** setting and press **↵ Enter**.

You see a screen with boundary lines indicating areas that are overlapping. The boundary lines are based on the **Top Edge**, **Bottom Edge**, **Right Edge**, and **Left Edge** settings you selected for the **Edge Blending** setting.

- Use the arrow buttons to select a boundary line of the area you want to adjust and press **↵ Enter**. The selected line is displayed in orange.



- Use the arrow buttons to adjust the boundary line position and press **↵ Enter**.

14. Use the arrow buttons to select an adjustment point and press **↵ Enter**.

Note: You can change the number of adjustment points displayed by changing the **Points** setting in the Area Correction menu.

The selected point turns orange.

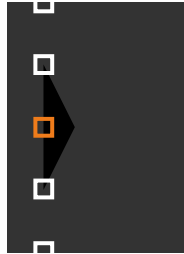

15. Use the arrow buttons to move the point.
16. To move another point, press the **Esc** button and repeat the previous two steps.
17. To move another boundary line, press the **Esc** button repeatedly until you can select a boundary line.
18. When you are finished, press the **Esc** button until you see a confirmation message. Select **Yes** and press **↵ Enter**.
19. When you are finished, press the **Menu** button.

Note: Changing the **Top Edge**, **Bottom Edge**, **Right Edge**, or **Left Edge** settings resets the **Black Level** setting to its default value.

Parent topic: [Using Multiple Projectors](#)

Related references

[Multiple Projector Operation Settings - Multi-Projection Menu](#)

Matching the Image Colors

You can match the display color of multiple projectors that will project next to one another. Turn on all the projectors so you can properly adjust the color of the combined screen.

1. Press the **Menu** button.

2. Select the **Multi-Projection** menu and press **↵ Enter**.

Frequently Used Items	Multi-Projection
Image	Projector ID Off
Signal I/O	HDMI Out Setting Off
Installation	Tiling
Display	Geometry Correction Point Correction
Operation	Edge Blending
Management	Scale
Network	Color Uniformity
Multi-Projection	Light Source Mode Normal
Memory	Color Matching
Initial/All Settings	RGBCMY
	Reset Multi-Projection Settings
	Memory
	Save Memory
	Load Memory
	Rename Memory
	Erase Memory
	Reset Memory Settings

3. Select the **Color Matching** setting and press **↵ Enter**.
You see this screen:

[Color Matching]	Return
Adjustment Level	1 ◀ ▶
Red	0 —
Green	0 —
Blue	0 —
Brightness	- +

4. Press the left or right arrow button to select **Adjustment Level 8**.

Note: There are several adjustment levels and you can adjust each level individually.

5. Press the left or right arrow buttons to adjust the **Brightness** setting.
6. Press the left or right arrow buttons to adjust the color tone for the **Red**, **Green**, and **Blue** settings if necessary.
7. Press **Esc** to return to the Multi-Projection menu.
8. Select the **Operation** menu and press **↵ Enter**.
9. Select **Light Source Brightness Control** and press **↵ Enter**.
10. Set the **Light Source Mode** setting to **Custom** and adjust the **Brightness Level** setting as necessary.
11. Press **Esc** and repeat steps 2 through 6 for **Adjustment Level 7** through **2**.
12. When you are finished, press the **Menu** button.

Parent topic: [Using Multiple Projectors](#)

Related references

[Multiple Projector Operation Settings - Multi-Projection Menu](#)

Scaling an Image

You can project the same image from multiple projectors and use the Scale feature to crop and combine them into one large image.

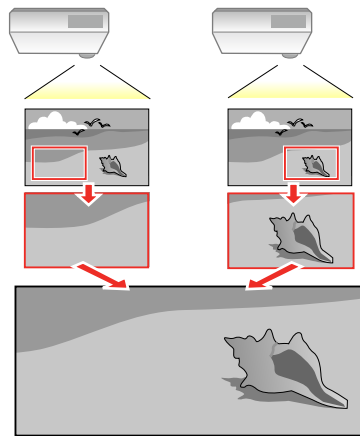

1. Press the **Menu** button.
2. Select the **Multi-Projection** menu and press **↵ Enter**.
3. Select the **Scale** setting and press **↵ Enter**.

You see this screen:

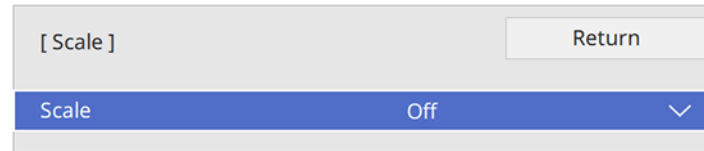

4. Select one of the following as the **Scale** setting:
 - **Auto** to automatically adjust the clipped areas according to the **HDMI Out Setting** and **Edge Blending** settings you selected
 - **Manual** to adjust the clipped areas manually
5. Select the **Scale Mode** setting and select one of these options:
 - **Zoom Display** to maintain the image aspect ratio as you scale the image

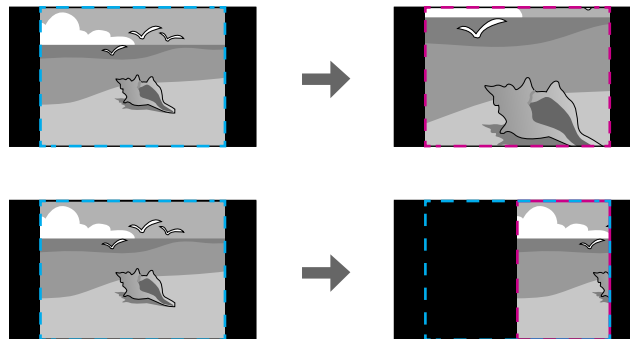

- **Full Display** to adjust the image to the projector's screen size as you scale the image

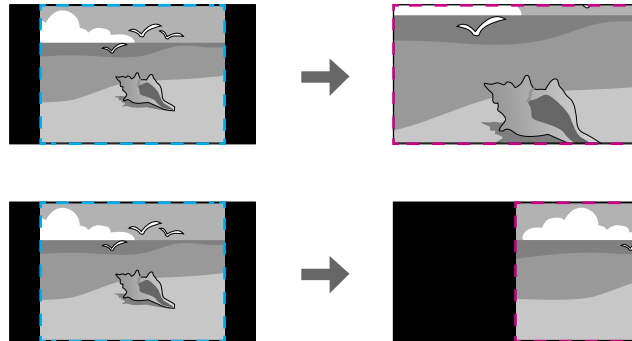

6. If you selected **Auto** as the Scale setting, you can skip the remaining steps. If you selected **Manual**, adjust each of the following options as necessary:
 - Select **-** or **+** to scale the image horizontally and vertically at the same time
 - Select **Scale Vertically** to scale the image vertically only
 - Select **Scale Horizontally** to scale the image horizontally only
7. Select the **Clip Adjustment** setting and use the arrow buttons to adjust the coordinates and size of each image as you view the screen.
8. Select the **Clip Range** setting to preview the area you just selected.
9. Press the **Menu** button to exit.

Parent topic: [Using Multiple Projectors](#)

Related references

[Multiple Projector Operation Settings - Multi-Projection Menu](#)

Saving Settings to Memory and Using Saved Settings

You can save customized settings for each of your video inputs and then select the saved settings whenever you want to use them.

1. Turn on the projector and display an image.
2. Press the **Menu** button.
3. Select the **Memory** menu and press **Enter**.

You see this screen:

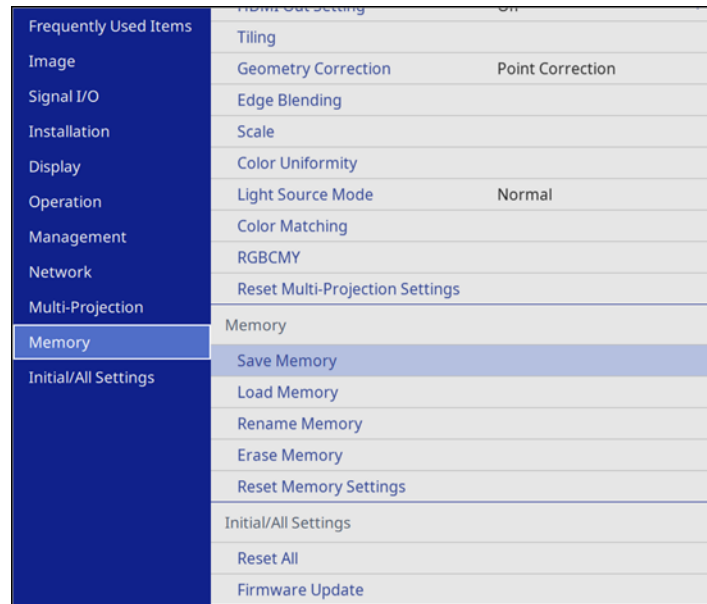

4. Select one of the following options:

- **Load Memory:** Overwrites your current settings with saved settings
- **Save Memory:** Saves your current settings to memory (10 memories with different names are available)

Note: A memory name that has already been used is indicated by a blue mark. Saving over a previously saved memory overwrites the settings with your current settings.

Note: You can save the following settings:

- Image menu settings for each color mode
- **Video Range** and **Overscan** in the Signal I/O menu
- **Light Source Mode** and **Brightness Level** in the Operation menu
- **Erase Memory:** Erases the selected memory settings
- **Rename Memory:** Renames a saved memory

- **Reset Memory Settings:** Delete all saved memory

5. Press **Esc** to exit.

Parent topic: [Adjusting Projector Features](#)

Related references

[Input Signal Settings - Signal I/O Menu](#)

[Feature Settings - Operation Menu](#)

Adjusting the Color Tone (Color Uniformity)

You can use the Color Uniformity feature to manually adjust the color tone balance in the projected image.

Note: The color tone may not be uniform even after adjusting the color uniformity.

1. Press the **Menu** button.
2. Select the **Management** menu and press **↵ Enter**.

Frequently Used Items	Management
Image	User Button Light Source Mode
Signal I/O	User's Logo
Installation	Control Panel Lock Off
Display	Color Uniformity
Operation	Refresh Mode
Management	Light Source Calibration
Network	Date & Time
Multi-Projection	Schedule Settings
Memory	Wireless LAN Power
Initial/All Settings	Wireless LAN Diagnosis 1
	Log Save Destination USB and Internal Memory
	Batch Setup Range
	Language 🌐 English
	Information
	Display Logs
	Reset Management Settings
	Network

3. Select the **Color Uniformity** setting and press **↵ Enter**.
4. Select the **Color Uniformity** setting again and press **↵ Enter**.
5. Select **On** and press **Esc**.
6. Select the **Adjustment Level** setting and press **↵ Enter**.
7. Press the right and left arrow buttons to adjust the level, and press **Esc**.
8. Select the **Start Adjustments** setting and press **↵ Enter**.
9. Select the area of the screen that you want to adjust and press **↵ Enter**.

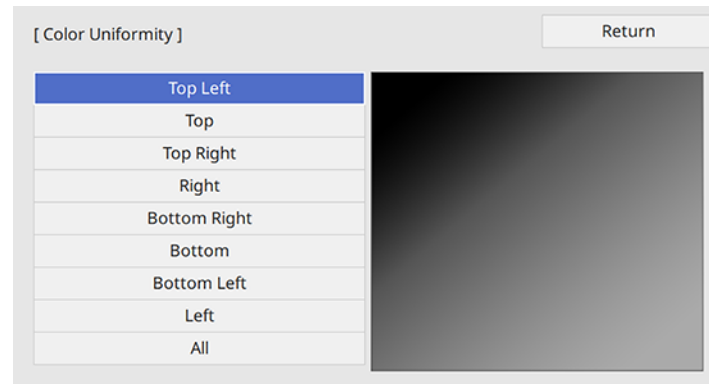

Note: Adjust the outer areas first, then adjust the entire screen.

10. Select the color (**Red**, **Green**, or **Blue**) you want to adjust, and use the left arrow button to weaken the color tone and the right arrow button to strengthen the color tone.
11. Press **Esc**.
12. Repeat steps 9 and 10 for each area you want to adjust.
13. Repeat steps 6 to 10 for each adjustment level.
14. When you are finished, press the **Menu** button.

Parent topic: [Adjusting Projector Features](#)

Running Light Source Calibration

Light source calibration automatically adjusts any difference between the white balance and the brightness level of the light source. You should perform light source calibration every 100 hours of

projector usage. You can also schedule automatic calibration or run the light source calibration manually using the menus.

Automatic light source calibration may not start in the following conditions:

- Within 20 minutes of turning on the projector.
- When using direct power shutdown.
- When you have used the projector continuously for over 24 hours.
- When the brightness is automatically dimmed due to high temperatures.

Note: To perform a light source calibration, the projector must have been on for at least 20 minutes and the projector brightness must not be automatically dimmed due to high temperatures.

1. Press the **Menu** button.
2. Select the **Management** menu and press **↵ Enter**.

You see a screen like this:

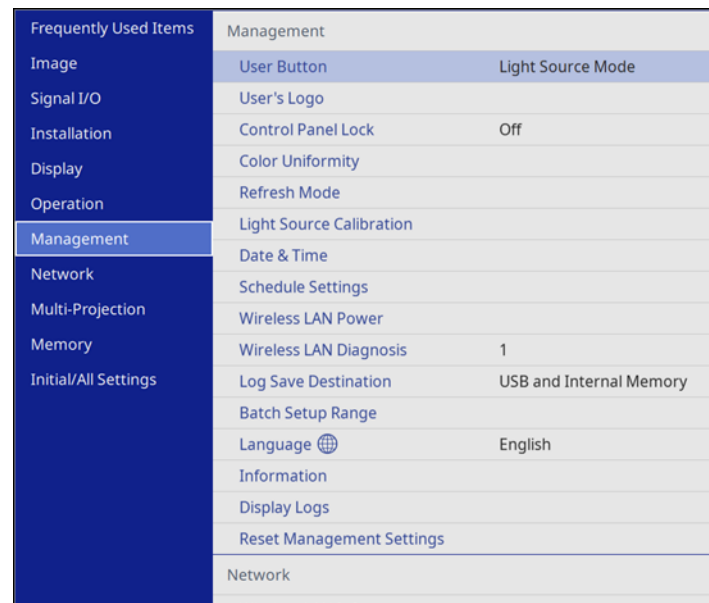

The screenshot shows a menu interface with a dark blue sidebar on the left and a main content area on the right. The sidebar lists various menu categories: Frequently Used Items, Image, Signal I/O, Installation, Display, Operation, Management (highlighted in light blue), Network, Multi-Projection, Memory, and Initial/All Settings. The main content area displays the 'Management' menu with the following items: User Button (with 'Light Source Mode' to its right), User's Logo, Control Panel Lock (with 'Off' to its right), Color Uniformity, Refresh Mode, Light Source Calibration, Date & Time, Schedule Settings, Wireless LAN Power, Wireless LAN Diagnosis (with '1' to its right), Log Save Destination (with 'USB and Internal Memory' to its right), Batch Setup Range, Language (with a globe icon and 'English' to its right), Information, Display Logs, and Reset Management Settings. At the bottom of the main content area, the 'Network' menu item is partially visible.

Frequently Used Items	Management
Image	User Button Light Source Mode
Signal I/O	User's Logo
Installation	Control Panel Lock Off
Display	Color Uniformity
Operation	Refresh Mode
Management	Light Source Calibration
Network	Date & Time
Multi-Projection	Schedule Settings
Memory	Wireless LAN Power
Initial/All Settings	Wireless LAN Diagnosis 1
	Log Save Destination USB and Internal Memory
	Batch Setup Range
	Language 🌐 English
	Information
	Display Logs
	Reset Management Settings
	Network

3. Select **Light Source Calibration** and press **Enter**.

4. Select any of the following:
 - To run the light source calibration now, select **Run Now**.
 - To automatically run the light source calibration every 100 hours of projector usage, select **Run Periodically**.
 - To schedule automatic calibration, select **Schedule Settings**.
 - To see the last time the projector performed a calibration, select **Last Run**.
5. When you are finished, press the **Menu** button to exit the menus.

Parent topic: [Adjusting Projector Features](#)

Related references

[Projector Environmental Specifications](#)

Scheduling Projector Events

You can save a projector command, such as turning the projector on or off or switching input sources, as an "event." You can schedule when you want the projector to automatically execute the command.

Caution: Do not place flammable objects in front of the lens. If you schedule the projector to turn on automatically, flammable objects in front of the lens could catch on fire.

Note: The **Schedule** setting in the Menu Protection menu must be turned off to schedule an event.

[Saving a Scheduled Event](#)

[Viewing Scheduled Events](#)

[Editing a Scheduled Event](#)

Parent topic: [Adjusting Projector Features](#)

Related tasks

[Selecting Password Security Types](#)

[Running Light Source Calibration](#)

Saving a Scheduled Event

You can select projector commands you want to perform and schedule them as an event.

Note: Light Source Calibration events do not start if the projector is not used continuously for at least 20 minutes, if the projector has been running for more than 24 hours, or if the projector is regularly turned

off by shutting off the power outlet. Set Light Source Calibration events to occur only after 100 hours of usage.

Note: The **Schedule** setting in the Menu Protection menu must be turned off to schedule an event.

1. Set the date and time in the **Management** menu.
2. Press the **Menu** button.
3. Select the **Management** menu and press **↵ Enter**.
4. Select the **Schedule Settings** setting and press **↵ Enter**.
5. Select the **Schedule** menu and press **↵ Enter**.

You see a screen like this:

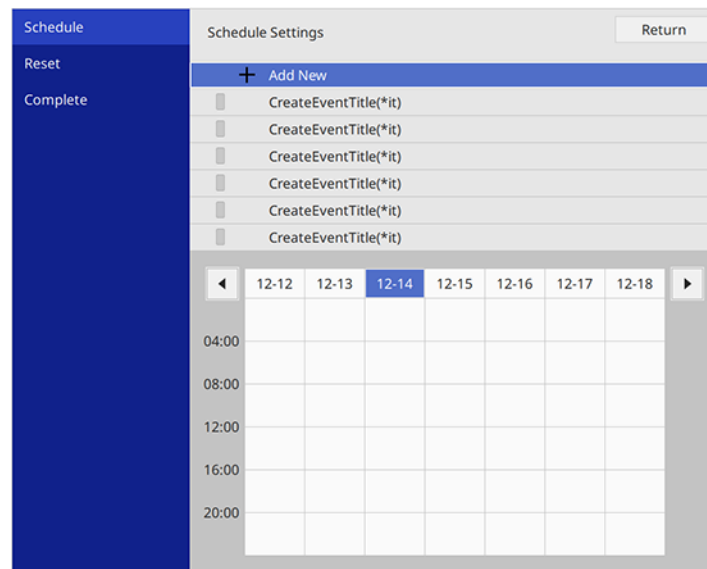

6. Select **Add New** and press **↵ Enter**.

You see a screen like this:

The screenshot shows the 'Event Settings' screen. On the left is a dark blue sidebar with 'Schedule' (highlighted), 'Reset', and 'Complete'. The main area is titled 'Event Settings' and contains: Power (No Change), Source (HDMI2), Light Source Mode (On), A/V Mute (Off), and Volume (Change, 10). Below is 'Date / Time Settings' with Type (Date), Date (2019-04-26), Day of the Week (checkboxes), and Time (12:00). 'Save' and 'Cancel' buttons are at the bottom right.

7. In the Event Settings section, select the events you want to have occur. (Select **No Change** for events that you do not want to occur.)
8. In the Date/Time Settings section, set the date and time for the scheduled events to occur.
9. When you are finished, select **Save** and press **↵ Enter**.
10. To schedule more events, repeat the previous steps as necessary.
11. Select **Setup complete** and select **Yes** to save your changes.

Parent topic: [Scheduling Projector Events](#)

Related tasks

[Selecting Password Security Types](#)

Viewing Scheduled Events

You can view your scheduled events on the calendar displayed on the Schedule Settings screen.



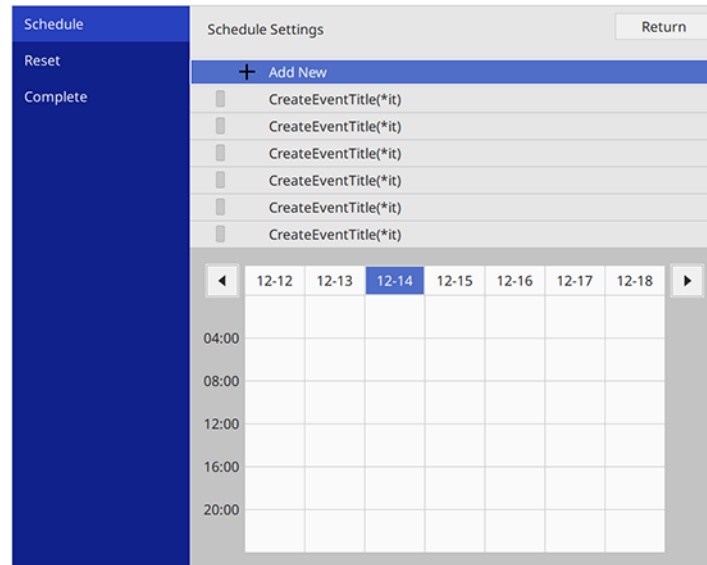

1. Press the **Menu** button.
2. Select the **Management** menu and press **↵ Enter**.

3. Select **Schedule Settings** and press **↵ Enter**.
4. Select **Schedule** and press **↵ Enter**.

You see a screen like this:



Colored boxes on the calendar indicate the following:

-  One-time event
-  Repeating event
-  Communication is on or off
-  Event is invalid

5. To view an event, press the left and right arrow buttons on the remote to select a day.
The screen displays the details of the events scheduled for that day. A blue icon indicates an enabled event, a gray icon indicates a disabled event, and the  icon indicates a repeating event.

Parent topic: [Scheduling Projector Events](#)

Editing a Scheduled Event

You can edit any currently scheduled event.

1. Press the **Menu** button.
2. Select the **Management** menu and press **↵ Enter**.
3. Select the **Schedule Settings** setting and press **↵ Enter**.

You see a screen like this:

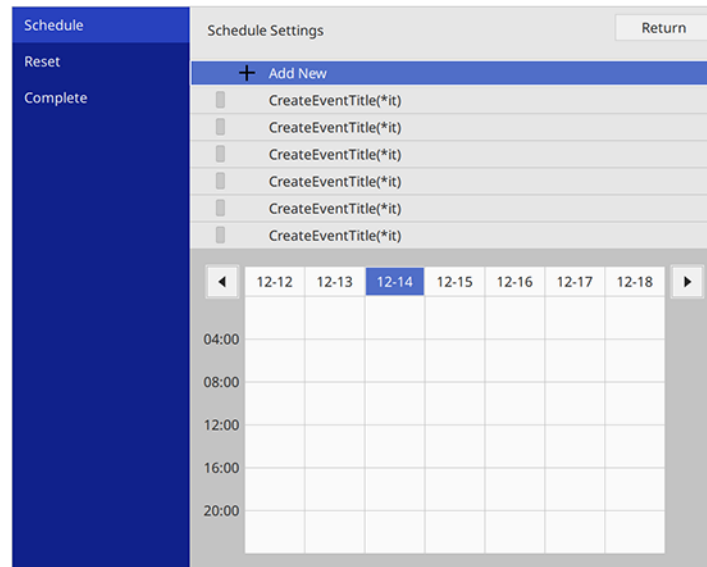

4. Press the left or right arrow buttons to highlight the date on the calendar containing the scheduled event you want to edit.
5. Press the up or down arrow buttons to highlight the event you want to edit, and press **Esc**.
6. Select one of the following:
 - **On/Off** to enable or disable the selected event.
 - **Edit** to edit the settings for the selected event.
 - **Clear** to delete the selected event.
 - **Add New** to add a new scheduled event.

7. When you are finished, select **Return** and press **↵ Enter**.
8. Select **Setup complete** and select **Yes** to save your changes.

Note: To delete all scheduled events, select **Schedule Reset** and select **Yes**.

Parent topic: [Scheduling Projector Events](#)

Copying Menu Settings Between Projectors

After you select menu settings for your projector, you can transfer them to another projector of the same model.

Note: Copy the projector's settings before you adjust the projected image using the projector's image adjustment settings. Any saved User's Logo setting on the projector will transfer to the other projector.

Caution: If the copy process fails due to a power failure, communication error, or for any other reason, Epson will not be responsible for any repair costs incurred.

The following settings will not transfer between projectors:

- Light Source Hours
- Status
- Any settings unique to a specific projector, such as **Screen Mirroring** settings

The following settings will not transfer between projectors if you set the **Batch Setup Range** setting to **Limited**:

- Password Protection settings
- **EDID** in the Signal I/O menu
- Network menu settings

Note: In addition to the methods covered in this section, you can also copy and transfer settings to multiple projectors over a network using the Epson Projector Management software. See the online *Epson Projector Management Operation Guide* for instructions. You can download the latest software and documentation from the Epson website.

[Saving Settings to a USB Flash Drive](#)

[Transferring Settings from a USB Flash Drive](#)

[Saving Settings to a Computer](#)

Transferring Settings from a Computer

Parent topic: [Adjusting Projector Features](#)

Related references

[Administration Settings - Management Menu](#)

[Additional Projector Software and Manuals](#)

Saving Settings to a USB Flash Drive

You can save the projector settings you want to transfer to a USB flash drive.

Note: Use an empty flash drive. If the drive contains other files, the transfer may not complete correctly. The flash drive must use the FAT format and cannot have any security features.

1. Turn off the projector and unplug the power cord from the projector's power inlet.
2. Insert the flash drive into the **USB-A** port.

Note: Connect the flash drive directly to the projector. Do not use a hub or your settings may not be saved correctly.

3. Press and hold the **Esc** button on the control panel or remote control as you connect the power cord to the projector's power inlet.

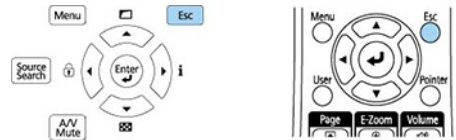

4. When all of the projector lights turn on, release the **Esc** button.

The lights flash to indicate that settings are transferring to the flash drive. When the lights stop flashing, the On/Standby light turns blue and the projector enters standby mode.

Caution: Do not unplug the power cord or remove the flash drive while the lights are flashing. This could damage the projector.

5. Once the projector enters standby mode, remove the flash drive.

Note: If the projector does not enter standby mode and the lights continue flashing, see the link below for a solution.

Parent topic: [Copying Menu Settings Between Projectors](#)

Related references

[Projector Light Status](#)

Related tasks

[Connecting to a USB Device](#)

Transferring Settings from a USB Flash Drive

After saving projector settings to a USB flash drive, you can transfer them to another projector of the same model.

Note: Make sure the USB flash drive contains only a single settings transfer from another projector of the same model. The settings are contained in a file called **pjconfdata.bin**. If the drive contains other files, the transfer may not complete correctly.

Do not adjust image settings on a projector until after you transfer settings to it. Otherwise, you may have to repeat your adjustments.

1. Turn off the projector and unplug the power cord from the projector's power inlet.
2. Insert the flash drive into the **USB-A** port.

Note: Connect the flash drive directly to the projector. Do not use a hub or your settings may not be saved correctly.

3. Press and hold the **Menu** button on the control panel or remote control as you connect the power cord to the projector's power inlet.

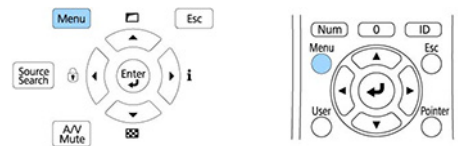

4. When all of the projector lights turn on, release the **Menu** button.

The lights flash to indicate that settings are transferring to the projector. When the lights stop flashing, the On/Standby light turns blue and the projector enters standby mode.

Caution: Do not unplug the power cord or remove the flash drive while the lights are flashing. This could damage the projector.

5. Once the projector enters standby mode, remove the flash drive.

Note: If the projector does not enter standby mode and the lights continue flashing, see the link below for a solution.

Parent topic: [Copying Menu Settings Between Projectors](#)

Related references

[Projector Light Status](#)

Related tasks

[Connecting to a USB Device](#)

Saving Settings to a Computer

You can save the projector settings you want to transfer to a computer.

Your computer must be running one of the following operating systems:

- Windows 7
- Windows 8.x
- Windows 10
- OS X 10.11.x
- macOS 10.12.x
- macOS 10.13.x
- macOS 10.14.x
- macOS 10.15.x
- macOS 11.x

1. Turn off the projector and unplug the power cord from the projector's power inlet.

2. Connect a USB Type-A to Type-B cable to your projector's **Service** port.
3. Connect the other end to any available USB port on your computer.
4. Press and hold the **Esc** button on the control panel or remote control as you connect the power cord to the projector's power inlet.

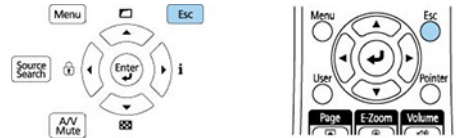

5. When all of the projector lights turn on, release the **Esc** button.
The projector shows up as a removable disk on your computer.
6. Open the removable disk and copy the **pjconfdata.bin** file to your computer.
7. Once the file has copied, do one of the following:
 - **Windows:** Open the **My Computer**, **Computer**, **Windows Explorer**, or **File Explorer** utility. Right-click the name of your projector (listed as a removable disk) and select **Eject**.
 - **Mac:** Drag the removable disk icon for your projector from the desktop into the trash.The projector turns off when you disconnect the USB cable.

Note: If the projector does not turn off and the lights continue flashing, see the link below for a solution.

Parent topic: [Copying Menu Settings Between Projectors](#)

Related references

[Projector Light Status](#)

Transferring Settings from a Computer

After saving projector settings to a computer, you can transfer them to another projector of the same model.

Your computer must be running one of the following operating systems:

- Windows 7
- Windows 8.x

- Windows 10
- OS X 10.11.x
- macOS 10.12.x
- macOS 10.13.x
- macOS 10.14.x
- macOS 10.15.x
- macOS 11.x

Do not adjust image settings on a projector until after you transfer settings to it. Otherwise, you may have to repeat your adjustments.

1. Turn off the projector and unplug the power cord from the projector's power inlet.
2. Connect a USB cable to your projector's **Service** port.
3. Connect the other end to any available USB port on your computer.
4. Press and hold the **Menu** button on the control panel or remote control as you connect the power cord to the projector's power inlet.

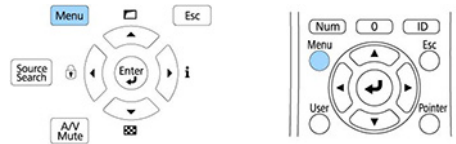

5. When all of the projector lights turn on, release the **Menu** button.
The projector shows up as a removable disk on your computer.
6. Copy the **pjconfdata.bin** file from your computer to the removable disk.

Note: Do not copy any other files to the removable disk.

7. Once the file has copied, do one of the following:
 - **Windows:** Open the **My Computer**, **Computer**, **Windows Explorer**, or **File Explorer** utility. Right-click the name of your projector (listed as a removable disk) and select **Eject**.
 - **Mac:** Drag the removable disk icon for your projector from the desktop into the trash.

All the lights start flashing to indicate that the projector's settings are being updated. Disconnect the USB cable. When all of the indicators stop flashing, the projector turns off.

Caution: Do not unplug the power cord while the lights are flashing. This could damage the projector.

Note: If the projector does not turn off and the lights continue flashing, see the link below for a solution.

Parent topic: [Copying Menu Settings Between Projectors](#)

Related references

[Projector Light Status](#)

Adjusting the Menu Settings

Follow the instructions in these sections to access the projector menu system and change projector settings.

[Using the Projector's Menus](#)

[Image Quality Settings - Image Menu](#)

[Input Signal Settings - Signal I/O Menu](#)

[Installation Settings - Installation Menu](#)

[Display Settings - Display Menu](#)

[Feature Settings - Operation Menu](#)

[Administration Settings - Management Menu](#)

[Network Settings - Network Menu](#)

[Multiple Projector Operation Settings - Multi-Projection Menu](#)

[Image Quality Memory Settings - Memory Menu](#)

[Initial Settings and Reset Options - Initial/All Settings Menu](#)

Using the Projector's Menus

You can use the projector's menus to adjust the settings that control how your projector works. The projector displays the menus on the screen.

1. Press the **Menu** button on the control panel or remote control.
You see the menu screen.

Frequently Used Items	Image	
Image	Color Mode	Presentation
Signal I/O	Brightness	50
Installation	Contrast	50
Display	Color Saturation	50
Operation	Tint	50
Management	Sharpness	50
Network	White Balance	
Multi-Projection	Dynamic Contrast	Off
Memory	Image Enhancement	
Initial/All Settings	Scene Adaptive Gamma	5
	Gamma	0
	RGBCMY	
	Reset to Defaults	
	Source	Computer1
	Resolution	Auto
	Aspect	Auto
	Analog Signal Adjustment	
	Reset to Defaults	

2. Press the up or down arrow button to move through the menus listed on the left. The settings for each menu are displayed on the right.

Note: The available settings depend on the current input source, resolution, or other menu settings.

3. To change settings in the displayed menu, press **↵ Enter**.
4. Press the up or down arrow button to move through the settings.
5. Change the settings using the buttons listed on the bottom of the menu screens.
6. To return all the menu settings to their default values, select the **Initial/All Settings** menu.
7. When you finish changing settings on a menu, press **Esc**.
8. Press **Menu** or **Esc** to exit the menus.

Note: The  icon indicates that a setting contains sub-settings.

Parent topic: [Adjusting the Menu Settings](#)

Image Quality Settings - Image Menu

Settings on the Image menu let you adjust the quality of your image for the input source you are currently using. The available settings depend on the currently selected color mode and input source.

Frequently Used Items	Image	
Image	Color Mode	Presentation
Signal I/O	Brightness	50
Installation	Contrast	50
Display	Color Saturation	50
Operation	Tint	50
Management	Sharpness	50
Network	White Balance	
Multi-Projection	Dynamic Contrast	Off
Memory	Image Enhancement	
Initial/All Settings	Scene Adaptive Gamma	5
	Gamma	0
	RGBCMY	
	Reset to Defaults	
	Source	Computer1
	Resolution	Auto
	Aspect	Auto
	Analog Signal Adjustment	
	Reset to Defaults	

Color Mode Settings

Setting	Options	Description
Color Mode	See the list of available Color Modes	Adjusts the vividness of image colors for various image types and environments
Brightness	Varying levels available	Lightens or darkens the overall image
Contrast	Varying levels available	Adjusts the difference between light and dark areas of the image

Setting	Options	Description
Color Saturation	Varying levels available	Adjusts the intensity of the image colors
Tint	Varying levels available	Adjusts the balance of green to magenta tones in the image
Sharpness	Varying levels available	Adjusts the sharpness or softness of image details
White Balance	Color Temp. G-M Correction Custom	Sets the overall color tone of the image Color Temp.: sets the color temperature according to the selected color mode; lower values tint the image red, and higher values tint the image blue (this setting is not displayed when Color Filter is set to Warm White or Cool White) G-M Correction: makes fine adjustments to the color tone; higher values tint the image green and lower values tint the image red Custom: adjusts the individual RGB components of the offset and gain
Dynamic Contrast	Off Normal High Speed	Adjusts the projected luminance based on the image brightness

Setting	Options	Description
Image Enhancement	Image Preset Mode	Selects preset Image Enhancement settings
	Noise Reduction	Reduces flickering in analog images
	MPEG Noise Reduction	Reduces the noise or static in MPEG video
	Deinterlacing	Sets whether to convert interlaced-to-progressive signals for interlaced video signals (480i/576i/1080i) Off: for fast-moving video images Video: for most video images Film/Auto: for movies, computer graphics, and animation
	Super-resolution	Sharpens blurred images when projecting low-resolution images Fine Line Adjust: enhances the contrast and outlines of complicated images Soft Focus Detail: enhances the contrast and outlines of smooth backgrounds
	Detail Enhancement	Enhances details to create clear outlines Strength: higher settings create a stronger effect Range: higher settings increase the affected area around the outline
	Reset	Resets all settings in the Image Enhancement menu

Setting	Options	Description
Scene Adaptive Gamma	Various levels available	Adjusts the coloring according to the scene to obtain a more vivid image; larger numbers enhance the contrast. Cannot be adjusted for the USB , LAN , or Screen Mirroring sources.
Gamma	-2 to 2 Custom	Adjusts the colors by selecting one of the gamma correction values or referring to a gamma graph
RGBCMY	Varying levels available	Adjusts the hue, saturation, and brightness for each color
Reset to Defaults	—	Resets all settings for the Color Mode currently selected

Note: The **Brightness** setting does not affect laser brightness. To change the laser brightness mode, use the **Light Source Brightness Control** setting in the Operation menu.

Input Source Settings

To change settings for an input source, make sure the source is connected and select that source.

Note: You can restore the default settings of the **Tracking**, **Sync**, and **Position** settings by pressing the **Auto** button on the remote control.

Setting	Options	Description
Source	—	Displays the current input source selected
Resolution	Auto Normal Wide	Sets the VGA input signal resolution if not detected automatically using the Auto option (only for computer inputs)

Setting	Options	Description
Aspect	See the list of available aspect ratios	Sets the aspect ratio (width-to-height ratio) when the source is Computer , HDMI , or HDBaseT Turn off the Scale setting or set the Scale Mode setting to Full Display before selecting this setting.
Scale	Varying levels available	When using multiple projectors, adjusts the scale of the image displayed by each projector
Analog Signal Adjustment	Auto Setup Tracking Sync. Position	Adjusts the signal when Computer is the currently selected input source Auto Setup : set to On to automatically optimize the image quality Tracking : adjusts the signal to eliminate vertical stripes in images Sync : adjusts signal to eliminate fuzziness or flickering in images Position : adjusts the image location on the screen
Reset to Defaults	—	Resets all settings for the currently selected input source

Note: Select **Reset Image Settings** to reset all settings on the Image menu to their default values.

Parent topic: [Adjusting the Menu Settings](#)

Related concepts

[Image Aspect Ratio](#)

Related references

[Feature Settings - Operation Menu](#)

Related tasks

[Changing the Color Mode](#)

Turning On Dynamic Contrast
Adjusting Gamma

Input Signal Settings - Signal I/O Menu

Normally the projector detects and optimizes the input signal settings automatically. If you need to customize the settings, you can use the Signal I/O menu. The available settings depend on the currently selected input source.

Frequently Used Items	Signal I/O	
Image	Volume	
Signal I/O	Source	Computer1
Installation	Overscan	Auto
Display	Reset to Defaults	
Operation	EDID	
Management	HDMI IN EQ Level	
Network	HDMI Out Intensity	Off
Multi-Projection	A/V Output	While Projecting
Memory	Audio Output	Auto
Initial/All Settings	HDMI Audio Output	
	Monitor Out Port	Monitor Out
	HDMI Link	
	HDBaseT	
	Reset Signal I/O Settings	
	Installation	
	Fixed Installation	Off
	Test Pattern	

To change settings for an input source, make sure the source is connected and select that source.

Setting	Options	Description
Volume	Varying levels available	Adjusts the volume of the projector's speaker system or external speakers

Setting	Options	Description
Source	Signal Format Overscan HDMI IN EQ Level HDMI Out Intensity Reset to Defaults	Displays settings selected for the current input source Signal Format: sets the video range for certain input sources to match the setting of an input source Overscan: changes the projected image ratio to make the edges visible by a selectable percentage or automatically when projecting a component signal HDMI IN EQ Level: adjusts the HDMI input signal for each HDMI port; change the level if there is interference in the signal or there is no projected image HDMI Out Intensity: adjusts the signal intensity from the HDMI ports; change if the HDMI image does not display correctly (not available on the PowerLite EB-L520U) Reset to Defaults: resets all settings for the current input source
EDID	HDMI1 HDMI2 HDBaseT	EDID: describes the display capabilities of your projector when the selected input source is HDMI ; change this setting as necessary according to the resolution of the current input source
A/V Output	While Projecting Always On	Determines when the projector outputs audio and images to external devices; set to Always On to output audio and images when the projector is in standby mode
Audio Output	Auto Audio1 Audio2	Sets the audio input port when projecting from input sources other than HDMI, LAN, and Screen Mirroring
HDMI Audio Output	HDMI1 Audio Output HDMI2 Audio Output	Sets the audio input port when projecting from one of the HDMI ports

Setting	Options	Description
Monitor Out Port	Monitor Out Computer2	<p>Selects the function of the Computer2/Monitor Out port</p> <p>Monitor Out: select this option when outputting an image signal to an external monitor</p> <p>Computer2: select this option when inputting an image signal from a computer</p>
HDMI Link	Device Connections HDMI Link Audio Out Device Power On Link Power Off Link	<p>Adjusts the HDMI Link options that allow the projector or remote to control HDMI-connected devices that support the CEC standard</p> <p>Device Connections: lists the devices connected to the HDMI1 and HDMI2 ports when HDMI Link is enabled</p> <p>HDMI Link: enables or disables the HDMI Link feature</p> <p>Audio Out Device: selects whether to output audio from the internal speakers or a connected audio/visual system</p> <p>Power On Link: controls what happens when you turn on the projector or a linked device</p> <ul style="list-style-type: none"> • Bidirectional: automatically turns on the connected device when you turn on the projector, and vice versa • Device -> PJ: automatically turns on the projector when you turn on the connected device • PJ -> Device: automatically turns on the connected device when you turn on the projector <p>Power Off Link: controls whether linked devices are turned off when the projector is turned off</p>

Setting	Options	Description
HDBaseT	Control Communications Extron XTP	<p>Selects the communication settings for connections to an HDBaseT transmitter or switcher</p> <p>Control Communications: enables or disables communication from the Ethernet and serial ports on the transmitter; turning on this setting disables the projector's LAN and RS-232C ports (Extron XTP must be turned off to use this setting)</p> <p>Extron XTP: set to On when you connect an Extron XTP transmitter or switcher to the HDBaseT ports</p>
Reset Signal I/O Settings		Resets all settings on the Signal I/O menu to their default values

Parent topic: [Adjusting the Menu Settings](#)

Related tasks

[Setting Up Monitoring Using SNMP](#)

Installation Settings - Installation Menu

Settings on the Installation menu let you set up your projector for your installation environment. The available settings depend on the currently selected input source and other settings.

Frequently Used Items	Installation	
Image	Fixed Installation	Off
Signal I/O	Test Pattern	
Installation	Projection	Front/Ceiling
Display	Geometry Correction	Point Correction
Operation	Remote Receiver	Off
Management	Screen Type	16:9 ▼
Network	High Altitude Mode	Off
Multi-Projection	Source	Computer1
Memory	Blanking	
Initial/All Settings	Reset to Defaults	
	Reset Installation Settings	
	Display	
	No-signal Screen	Blue
	Startup Screen	On
	Home Screen Auto Disp.	On
	Sort Source Thumbnails	On
	Messages	On

Setting	Options	Description
Fixed Installation	On Off	Set to On if you installed the projector in a fixed location
Test Pattern	—	Displays a test pattern to assist in focusing and zooming the image and correcting image shape
Projection	Front Front/Ceiling Rear Rear/Ceiling	Selects the way the projector faces the screen so the image is oriented correctly

Setting	Options	Description
Geometry Correction	H/V-Keystone Quick Corner Arc Correction Point Correction Memory	<p>Adjusts image shape to rectangular (horizontally and vertically)</p> <p>H/V-Keystone: lets you manually correct horizontal and vertical sides and balance (the H-Balance and V-Balance settings are not available for the PowerLite EB-L520U)</p> <p>Quick Corner: select to correct image shape and alignment using an on-screen display</p> <p>Arc Correction: select to adjust the curve or arc of the horizontal and vertical sides</p> <p>Point Correction: select to divide the projected image into a grid and correct distortion by moving a selected point</p> <p>Memory: controls memory functions for current image shape settings</p> <ul style="list-style-type: none"> • Save Memory: saves the current image shape as a memory setting • Load Memory: loads a saved image shape memory • Rename Memory: renames a saved image shape memory • Erase Memory: deletes a saved image shape memory • Reset Memory: resets all the image shape memory settings
Digital Zoom (PowerLite EB-L630SU/EB-L635SU)	Varying levels available	Adjusts the size of the projected image
E-Zoom (PowerLite EB-L520U)	Varying levels available	Adjusts the size of the projected image

Setting	Options	Description
Image Shift (PowerLite EB-L630SU/EB-L635SU)	Varying positions available	Adjusts the position of the projected image
Remote Receiver	Front/Rear Front Rear Off	Limits reception of remote control signals by the selected receiver; Off turns off all receivers
Screen Type	4:3 16:6 16:9 16:10	Sets the aspect ratio to fit the image on the projection surface; not available in Content Playback mode
Screen Position	Varying positions available	Shifts the image position on the screen (only available if the Screen Type setting is not set to the same aspect ratio as the projector's native resolution)
High Altitude Mode	On Off	Regulates the projector's operating temperature at altitudes above 4921 feet (1500 m)
Source	—	Displays settings saved for each input source
Blanking	Top Bottom Left Right	Hides an area of the projected image that you select (setting only displayed when Content Playback is Off)
Reset to Defaults	—	Resets all settings for the current input source (setting only displayed when Content Playback is Off)

Setting	Options	Description
Reset Installation Settings	—	Resets all settings on the Installation menu to their default values except for the following: <ul style="list-style-type: none"> • Digital Zoom • E-Zoom • Image Shift

Parent topic: [Adjusting the Menu Settings](#)

Related concepts

[Projection Modes](#)

Related tasks

[Displaying a Test Pattern](#)

[Correcting Image Shape with H/V-Keystone](#)

[Correcting Image Shape with Quick Corner](#)

[Correcting Image Shape with Arc Correction](#)

[Correcting Image Shape with Point Correction](#)

[Resizing the Image using Digital Zoom](#)

[Adjusting the Image Position Using Image Shift](#)

[Setting the Screen Type](#)

Display Settings - Display Menu

Settings on the Display menu let you customize various projector display features. The available settings depend on the currently selected input source and other settings.

Frequently Used Items	Display	
Image	No-signal Screen	Blue
Signal I/O	Startup Screen	On
Installation	Home Screen Auto Disp.	On
Display	Sort Source Thumbnails	On
Operation	Messages	On
Management	Menu Rotation	Off
Network	Menu Color	White
Multi-Projection	Air Filter Notice	On
Memory	Split Screen Setting	
Initial/All Settings	Reset Display Settings	
	Operation	
	Auto Source Search	On
	Light Source Brightness Cont...	
	Direct Power On	Off
	Auto Power On	Off
	Sleep Mode	On
	Sleep Mode Timer	10 min.

Setting	Options	Description
No-signal Screen	Black Blue Logo Gradation	Select the screen color or logo to display when no input signal is detected; not available in Content Playback mode
Startup Screen	On Off	Controls whether a logo is displayed when the projector starts up
Home Screen Auto Disp.	On Off	Controls whether the Home screen is displayed automatically when no input signal is detected when the projector turns on

Setting	Options	Description
Sort Source Thumbnails	On Off	Displays the detected input source in the upper left position of the Home screen. The display order of the input sources changes when the projector detects an input signal.
Messages	On Off	Controls whether projector status and error messages are displayed on the projected image
Menu Rotation	Right 90 Degree Left 90 Degree Off	Rotates the menu display 90°
Menu Color	White Black	Sets the color theme of the Home screen and projector menu system.
Air Filter Notice	On Off	Displays a message when a clog in the air filter is detected
Split Screen Setting	Display Audio Output Source Align	Adjusts the Split Screen feature; not available in Content Playback mode Display Audio Output Source: controls whether an icon is displayed with the source providing audio output during Split Screen projection Align: if splitting the screen between two images, determines whether the images are aligned at the top or in the middle of the screen
Reset Display Settings	—	Resets all settings on the Display menu to their default values

Note: You must disable the **Menu Protection** setting for the User's Logo to adjust the **No-signal Screen** and **Startup Screen** settings.

Parent topic: [Adjusting the Menu Settings](#)

Related tasks

[Selecting Password Security Types](#)

Feature Settings - Operation Menu

Settings on the Operation menu let you customize various projector features that control its operation. The available settings depend on the currently selected input source and other settings.

Frequently Used Items	Operation	
Image	Auto Source Search	On
Signal I/O	Light Source Brightness Cont...	
Installation	Direct Power On	Off
Display	Auto Power On	Off
Operation	Sleep Mode	On
Management	Sleep Mode Timer	10 min.
Network	A/V Mute Timer	On
Multi-Projection	Standby Mode	Communication On
Memory	Port	Wired LAN
Initial/All Settings	Quick Startup	Off
	USB Power	On While Projecting
	Indicators	On
	Beep	On
	Release A/V Mute	
	Inv Direction Button	Off
	Content Playback	Off
	Reset Operation Settings	
	Management	

Setting	Options	Description
Auto Source Search	On Off	Enables the projector to automatically select an input source; not available in Content Playback mode or when Quick Startup mode is enabled

Setting	Options	Description
Light Source Brightness Control	Maintain Brightness Maintain Brightness Level Estimated Remains Light Source Mode Brightness Level	<p>Controls the constant brightness of the projector's light source</p> <p>Maintain Brightness: maintains a constant brightness</p> <p>Maintain Brightness Level: selects the brightness level to maintain when the Maintain Brightness setting is enabled</p> <p>Estimated Remains: if the Maintain Brightness setting is enabled, displays the remaining number of hours the projector can maintain constant brightness</p> <p>Light Source Mode: selects the brightness mode of the projector when the Maintain Brightness setting is disabled</p> <ul style="list-style-type: none"> • Normal: maximum brightness • Quiet: 70% brightness with reduced fan noise • Extended: 70% brightness and extends the life expectancy of the light source • Custom: select a custom brightness level and enable use of the next setting <p>Brightness Level: select the Custom brightness level you want</p>
Direct Power On	On Off	<p>Controls whether the projector automatically turns on when you plug it in</p>

Setting	Options	Description
Auto Power On	HDMI1 Computer1 Off	Selects whether to automatically turn on the projector when you connect an input signal to a specific input source
Sleep Mode	On Off	Automatically turns off the projector after an interval of inactivity
Sleep Mode Timer	1 to 30 minutes	Sets the time before the projector automatically turns off (Sleep Mode must be turned on)
A/V Mute Timer	On Off	Automatically turns off the projector after 30 minutes of inactivity
Standby Mode	Communication On Communication Off	Enable this setting to allow monitoring and control of the projector over a network when the projector is in standby mode (setting is displayed only when A/V Output is set to While Projecting)
Port	Wired LAN Wireless LAN	Selects the port to use while the Standby Mode setting is set to Communication On
Startup Source	Various input sources available	Selects the source displayed on startup in Content Playback mode
Quick Startup	Off 20min. 60min. 90min.	Sets the time period for which you want to be able to restart the projector within five seconds of turning it off (Quick Start mode). It may take longer than five seconds when projecting from the projector's USB port or when using the Screen Mirroring features.

Setting	Options	Description
USB Power	On While Projecting Always On	Supplies power to the connected USB device; set to Always On to provide power when the projector is not projecting images; only available when A/V Output is set to While Projecting and Auto Power On is set to Off
Indicators	On Off	Enables or disables the status indicator lights on the projector
Beep	On Off	Controls the beep that sounds when you turn the projector on or off
Release A/V Mute	Any Button A/V Mute	Controls which buttons turn off the A/V Mute setting
Inv Direction Button	On Off	Enable this setting if you want to invert the direction of the arrow buttons on the control panel to match the projector's installation position
Content Playback	On Off	Enable to play back a playlist created in the Epson Projector Content Manager software
Overlay Effect	Overlay Effect Shape Filter Color Filter Lightness	Adds color and shape effects to the projected image; not available when Edge Blending is enabled
USB Viewer	—	Select a playlist from the USB device
Reset Operation Settings	—	Reset all settings on the Operation menu to their default values

Parent topic: [Adjusting the Menu Settings](#)

Related tasks

[Adjusting the Projector's Brightness Level](#)

[Switching to Content Playback Mode](#)

[Projecting a Playlist in Content Playback Mode](#)

[Turning On the Projector](#)

[Turning Off the Projector](#)

Administration Settings - Management Menu

Settings on the Management menu let you customize various projector administrative features.

Frequently Used Items	Management	
Image	User Button	Light Source Mode
Signal I/O	User's Logo	
Installation	Control Panel Lock	Off
Display	Color Uniformity	
Operation	Refresh Mode	
Management	Light Source Calibration	
Network	Date & Time	
Multi-Projection	Schedule Settings	
Memory	Wireless LAN Power	
Initial/All Settings	Wireless LAN Diagnosis	1
	Log Save Destination	USB and Internal Memory
	Batch Setup Range	
	Language	English
	Information	
	Display Logs	
	Reset Management Settings	
	Network	

Note: You must disable Schedule password protection to adjust the **Schedule Settings** settings.

Setting	Options	Description
User Button	Various options available	Assigns a menu option to the User button on the remote control for one-touch access

Setting	Options	Description
User's Logo	Start Setting Reset	Creates the screen that the projector displays to identify itself and enhance security
Control Panel Lock	Full Lock Except for Power Off	Controls projector button locking to secure the projector Full Lock: locks all buttons Except for Power: locks all buttons except the power button Off: no buttons locked
Color Uniformity	Color Uniformity Adjustment Level Start Adjustments Reset	Adjusts the color tone balance Color Uniformity: set to On to adjust the color tone balance for the whole screen Adjustment Level: sets the adjustment level Start Adjustments: adjusts the red, green, and blue color tones individually for the selected area Reset: resets all Color Uniformity adjustment values to their defaults
Refresh Mode	Timer Messages Start	Select Start to clear an afterimage that remains in the projected image and turn off the projector after the time specified in the Timer screen. Press any button to cancel Refresh Mode. Enable the Messages setting if you want to display a message when Refresh Mode is in progress.

Setting	Options	Description
Light Source Calibration	Run Now Run Periodically Last Run	Selects options to perform light source calibration to maintain the color balance of the projected image Run Now: Select On to start light source calibration now. Make sure the projector has been turned on for at least 30 minutes for maximum accuracy. You may not be able to start calibration if the projector's environmental temperature is out of range. Run Periodically: Select On to perform calibration every 100 hours of usage Last Run: Displays the date and time light source calibration was last performed
Date & Time	Date & Time Daylight Saving Time Internet Time	Adjusts the projector's date and time settings <ul style="list-style-type: none"> • Date & Time: sets the date and time on the projector • Daylight Saving Time: enables daylight saving time • Internet Time: updates the time automatically via an online time server
Schedule Settings	—	Schedules projector events to occur automatically at selected dates and times
Wireless LAN Power	On Off	Enables or disables wireless communication

Setting	Options	Description
Wireless LAN Diagnosis	Ping IP Address Ping until stopped Start	Displays the status of the wireless LAN communication
Log Save Destination	Internal Memory USB and Internal Memory	Selects where you want to save projector error and operation log files; not available in Content Playback mode
Batch Setup Range	All Limited	Selects which projector menu settings to copy using the batch setup feature; select All to copy all the settings, or select Limited to copy all settings except for the following: <ul style="list-style-type: none"> • Password Protection settings • EDID setting in the Signal I/O menu • Network menu settings
Language	Various languages available	Selects the language for projector menu and message displays
Information	Various options available	Displays information about the projector and current input signal; the displayed items vary depending on the current input source The Version option displays version numbers for the projector and other components
Display Logs	Display Status Power On/Off History	Displays log data saved to the location specified in the Log Save Destination setting

Setting	Options	Description
Reset Management Settings	—	Resets all settings on the Management menu to their default values except for Language

[Event ID Code List](#)

Parent topic: [Adjusting the Menu Settings](#)

Related tasks

[Saving a User's Logo Image to Display](#)

[Locking the Projector's Buttons](#)

[Adjusting the Color Tone \(Color Uniformity\)](#)

[Running Light Source Calibration](#)

[Setting the Date and Time](#)

[Selecting the Language for the Projector Menus](#)

Related topics

[Copying Menu Settings Between Projectors](#)

[Scheduling Projector Events](#)

Event ID Code List

If the **Event ID** option on the Information screen in the Management menu displays a code number, check this list of Event ID codes for the solution to the projector problem associated with the code.

Event ID code	Cause and solution
0026	A screen mirroring communication error has occurred. Turn the projector off and on again, or restart the network software.
0032	
0036	
0037	

Event ID code	Cause and solution
0027	Unstable screen mirroring communication. Check the network communication status, wait a few moments, and try connecting to the network again.
0028	
0029	
0030	
0031	
0035	
0023	Connection failed. If you see the PIN entry screen on your computer, enter the PIN code displayed on the network information screen or at the bottom right of the projected image. If this does not solve the problem, restart the projector and the connected devices, and then check the connection settings.
0024	
0025	
0043	The video format is not supported. Change the resolution of the mobile device and reconnect. Alternatively, change the Adjust Image Quality setting for the projector and reconnect.
0432	The network software did not start. Turn the projector off and then on again.
0435	
0433	Cannot display the transferred images. Restart the network software.
0434	Unstable network communication. Check the network communication status, wait a few moments, and try connecting to the network again.
0481	
0482	
0485	
0483	The network software quit unexpectedly. Check the network communication status, then turn the projector off and then on again.
04FE	
0484	Communication with computer was disconnected. Restart the network software.
0479	A projector system error has occurred. Turn the projector off and then on again.
04FF	
0891	Cannot find the SSID (network name). Make sure your computer and projector are connected to your access point's current SSID.

Event ID code	Cause and solution
0892	The WPA/WPA2/WPA3 authentication type does not match. Make sure the wireless network security settings are correct.
0893	The WEP/TKIP/AES encryption type does not match. Make sure the wireless network security settings are correct.
0894	Communication with unauthorized access point was disconnected. Contact your network administrator.
0895	Communication with a connected device was disconnected. Check your device's connection status.
0898	Failed to acquire DHCP address. Make sure the DHCP server is operating correctly. If you are not using DHCP, turn off the DHCP setting in the Network menus.
0899	A communication error has occurred. Try restarting the network software and restarting your projector. If that does not solve the problem, contact Epson for help.
089A	The EAP authentication type does not match the network. Check the wireless LAN security settings and make sure that the security certificate is installed correctly.
089B	EAP server authentication failed. Check the wireless LAN security settings and make sure that the security certificate is installed correctly.
089C	EAP client authentication failed. Check the wireless LAN security settings and make sure that the security certificate is installed correctly.
089D	Key exchange failed. Check the wireless LAN security settings and make sure that the security certificate is installed correctly.
0920	The internal battery that saves the projector's date and time settings is running low. Contact Epson for help.

Parent topic: [Administration Settings - Management Menu](#)

Related references

[Network Settings - Network Menu](#)

Related tasks

[Setting Up Wireless Network Security](#)

Network Settings - Network Menu

Settings on the Network menu let you view network information and set up the projector for control over a network.

Frequently Used Items	Network	
Image	Wireless LAN Info.	
Signal I/O	Wired LAN Info.	
Installation	Network Settings	
Display	Transmitter Settings	
Operation	Reset Network Settings	
Management	Multi-Projection	
Network	Projector ID	Off
Multi-Projection	HDMI Out Setting	Off
Memory	Tiling	
Initial/All Settings	Geometry Correction	Point Correction
	Edge Blending	
	Scale	
	Color Uniformity	
	Light Source Mode	Normal
	Color Matching	
	RGBCMY	
	Reset Multi-Projection Settings	

Note: You must disable Network password protection to adjust the network settings.

Setting	Options	Description
Wireless LAN Info.	Projector Name Wireless LAN	Displays wireless network status and details when the wireless LAN module is installed (PowerLite EB-L520U) or when the Wireless LAN Power or Simple AP setting is enabled
Wired LAN Info.	Projector Name DHCP IP Address Subnet Mask Gateway Address MAC Address	Displays wired network status and details
Network Settings	—	Configures your network settings

Setting	Options	Description
Reset Network Settings	—	Resets all settings on the Network menu to their default values

Parent topic: [Adjusting the Menu Settings](#)

Related concepts

[Wired Network Projection](#)

[Wireless Network Projection](#)

Related references

[Wireless LAN Menu Settings](#)

Multiple Projector Operation Settings - Multi-Projection Menu

Settings on the Multi-Projection menu let you set up multiple projectors to project a single unified image.

Frequently Used Items	Multi-Projection
Image	Projector ID Off
Signal I/O	HDMI Out Setting Off ▼
Installation	Tiling
Display	Geometry Correction Point Correction
Operation	Edge Blending
Management	Scale
Network	Color Uniformity
	Light Source Mode Normal
Multi-Projection	Color Matching
Memory	RGBCMY
Initial/All Settings	Reset Multi-Projection Settings
	Memory
	Save Memory
	Load Memory
	Rename Memory
	Erase Memory
	Reset Memory Settings

Setting	Options	Description
Projector ID	Off 1 through 9	Assigns an ID for the projector when you use multiple projectors
HDMI Out Setting (PowerLite EB-L530U/EB-L630U/EB-L630SU/EB-L635SU/EB-L730U/EB-L735U)	Pass Through Off	Set to Pass Through to enable up to four projectors connected via HDMI cables to project a unified image.
Number of Projectors (PowerLite EB-L530U/EB-L630U/EB-L630SU/EB-L635SU/EB-L730U/EB-L735U)	2 to 4	Sets the number of projectors used to create a unified image; this setting is displayed only if HDMI Out Setting is set to Pass Through
Order (PowerLite EB-L530U/EB-L630U/EB-L630SU/EB-L635SU/EB-L730U/EB-L735U)	1 to 4 (when HDMI Out Setting is set to Pass Through) 1 or 2 (when HDMI Out Setting is set to Process Out)	Sets the projector's position in numbered order from left to right
Tiling	Layout Location Setup	Sets the number of split screens and the position of each image; this setting is only displayed when the HDMI Out Setting is set to Off .

Setting	Options	Description
Geometry Correction	H/V-Keystone Quick Corner Arc Correction Point Correction Memory	<p>Adjusts image shape to rectangular (horizontally and vertically)</p> <p>H/V-Keystone: lets you manually correct horizontal and vertical sides</p> <p>Quick Corner: select to correct image shape and alignment using an on-screen display</p> <p>Arc Correction: select to adjust the curve or arc of the horizontal and vertical sides</p> <p>Point Correction: select to divide the projected image into a grid and correct distortion by moving a selected point</p> <p>Memory: controls memory functions for current image shape settings</p> <ul style="list-style-type: none"> • Save Memory: saves the current image shape as a memory setting • Load Memory: loads a saved image shape memory • Rename Memory: renames a saved image shape memory • Erase Memory: deletes a saved image shape memory • Reset Memory: resets all the image shape memory settings

Setting	Options	Description
Edge Blending	Edge Blending Top Edge Bottom Edge Left Edge Right Edge Line Guide Pattern Guide Guide Color	Blends the border between multiple images to create a seamless screen
Black Level	Color Adjustment Area Correction Reset	Adjusts the brightness and tone differences in overlapping images
Scale	Varying levels available	When using multiple projectors, adjusts the scale of the image displayed by each projector
Color Uniformity	Color Uniformity Adjustment Level Start Adjustments Reset	Adjusts the color tone balance Color Uniformity: set to On to adjust the color tone balance for the whole screen Adjustment Level: sets the adjustment level Start Adjustments: adjusts the red, green, and blue color tones individually for the selected area Reset: resets all Color Uniformity adjustment values to their defaults

Setting	Options	Description
Light Source Mode	Normal Quiet Extended Custom	Selects the brightness mode of the projector when the Maintain Brightness setting is disabled Normal: maximum brightness Quiet: 70% brightness with reduced fan noise Extended: 70% brightness and extends the life expectancy of the light source Custom: select a custom brightness level and enable use of the next setting
Color Matching	Adjustment Level Red Green Blue Brightness	Corrects the tint and brightness differences between images
RGBCMY	Varying levels available	Adjusts the hue, saturation, and brightness for each color
Reset Multi-Projection Settings	—	Resets all settings on the Multi-Projection menu to their default values

Parent topic: [Adjusting the Menu Settings](#)

Related concepts

[Using Multiple Projectors](#)

[Projector Identification System for Multiple Projector Control](#)

Related tasks

[Configuring Tiling Manually](#)

[Blending the Image Edges](#)

[Adjusting the Black Level](#)

Matching the Image Colors
Scaling an Image

Image Quality Memory Settings - Memory Menu

Settings on the Memory menu let you save and load image quality settings in the projector's memory.

Frequently Used Items	Home Out Setting	On
Image	Tiling	
Signal I/O	Geometry Correction	Point Correction
Installation	Edge Blending	
Display	Scale	
Operation	Color Uniformity	
Management	Light Source Mode	Normal
Network	Color Matching	
Multi-Projection	RGBCMY	
Memory	Reset Multi-Projection Settings	
Initial/All Settings	Memory	
	Save Memory	
	Load Memory	
	Rename Memory	
	Erase Memory	
	Reset Memory Settings	
	Initial/All Settings	
	Reset All	
	Firmware Update	

Setting	Options	Description
Save Memory	Memory 1 to 10	Lets you save the current image quality settings to memory
Load Memory	Memory 1 to 10	Loads a saved image quality setting memory
Rename Memory	Memory 1 to 10	Renames a saved image quality setting memory
Erase Memory	Memory 1 to 10	Deletes a saved image quality setting memory

Setting	Options	Description
Reset Memory	—	Resets all the image quality setting memory settings

Parent topic: [Adjusting the Menu Settings](#)

Related tasks

[Saving Settings to Memory and Using Saved Settings](#)

Initial Settings and Reset Options - Initial/All Settings Menu

You can reset most of the projector settings to their default values using the **Reset All** option on the Initial/All Settings menu.

When you select the **Reset All** option, you see this screen:

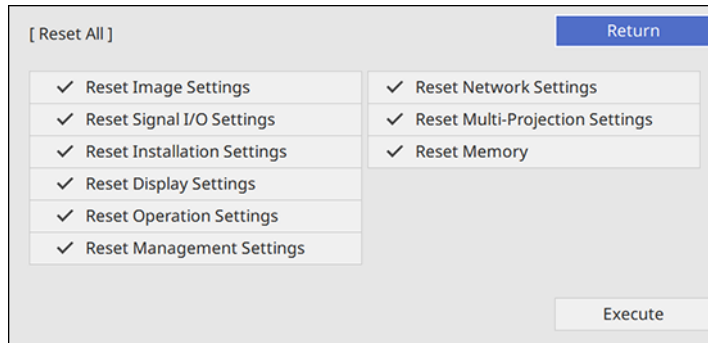

Checkmarks appear next to the menu settings that are selected to be reset. If you do not want to reset settings in some menus, deselect them. When you are ready, select **Execute** and press **↵ Enter**.

You cannot reset the following settings using the **Reset All** option:

- E-Zoom
- Digital Zoom
- Image Shift
- Language

Note: See the link below for details on updating the projector's firmware.

Parent topic: [Adjusting the Menu Settings](#)

Related concepts

[Updating the Firmware](#)

Maintaining and Transporting the Projector

Follow the instructions in these sections to maintain your projector and transport it from place to place.

[Projector Maintenance](#)

[Transporting the Projector](#)

[Updating the Firmware](#)

Projector Maintenance

Your projector needs little maintenance to keep working at its best.

You may need to clean the lens periodically, and clean the air filter and air vents to prevent the projector from overheating due to blocked ventilation.

The only parts you should replace are the air filter and remote control batteries. If any other part needs replacing, contact Epson or an authorized Epson servicer.

This projector uses a sealed laser light source which does not need servicing and cannot be replaced.

Warning: Before cleaning any part of the projector, turn it off, unplug the power cord, and let it cool down. Never open any cover on the projector, except as specifically explained in this manual. Dangerous electrical voltages in the projector can injure you severely.

Warning: Do not try to service this product yourself, except as specifically explained in this manual. Refer all other servicing to Epson qualified servicers.

[Cleaning the Lens](#)

[Cleaning the Projector Case](#)

[Air Filter and Vent Maintenance](#)

[Replacing the Remote Control Batteries](#)

Parent topic: [Maintaining and Transporting the Projector](#)

Cleaning the Lens

Clean the projector's lens periodically, or whenever you notice dust or smudges on the surface.

- To remove dust or smudges, gently wipe the lens with lens-cleaning paper.

- To remove stubborn smudges, moisten a soft, lint-free cloth with lens cleaner and gently wipe the lens. Do not spray any liquid directly on the lens.

Warning: Do not use a lens cleaner that contains flammable gas. The high heat generated by the projector may cause a fire.

Caution: Do not use glass cleaner or any harsh materials to clean the lens and do not subject the lens to any impacts; you may damage it. Do not use canned air, or the gases may leave a residue. Avoid touching the lens with your bare hands to prevent fingerprints on or damage to the lens surface.

Parent topic: [Projector Maintenance](#)

Cleaning the Projector Case

Before cleaning the projector case, turn off the projector and unplug the power cord.

- To remove dust or dirt, use a soft, dry, lint-free cloth.
- To remove stubborn dirt, use a soft cloth moistened with water and mild soap. Do not spray liquid directly on the projector.

Caution: Do not use wax, alcohol, benzene, paint thinner, or other chemicals to clean the projector case. These can damage the case. Do not use canned air, or the gases may leave a flammable residue.

Parent topic: [Projector Maintenance](#)

Air Filter and Vent Maintenance

Regular filter maintenance is important to maintaining your projector. Your Epson projector is designed with an easily accessible, user-replaceable filter to protect your projector and make regular maintenance simple. Filter maintenance intervals will depend on the environment.

If regular maintenance is not performed, your Epson projector will notify you when the temperature inside the projector has reached a high level. Do not wait until this warning appears to maintain your projector filter as prolonged exposure to high temperatures may reduce the life of your projector or laser.

Damage due to the failure to properly maintain the projector or its filter may not be covered by the projector's Limited Warranty.

[Cleaning the Air Filter](#)

[Replacing the Air Filter](#)

Parent topic: [Projector Maintenance](#)

Related references

[Optional Equipment and Replacement Parts \(U.S. and Canada\)](#)

[Optional Equipment and Replacement Parts \(Latin America\)](#)

Cleaning the Air Filter

You need to clean the projector's air filter in the following situations:

- The filter or vents get dusty.
- You see a message telling you to clean it.
- The projector's Filter light flashes orange.

Note: It is recommended that you clean the air filter every 20,000 hours. Clean it more often if the projector is in a dusty environment.

1. Turn off the projector and unplug the power cord.
2. Carefully remove the dust from the air filter cover with a vacuum or brush.

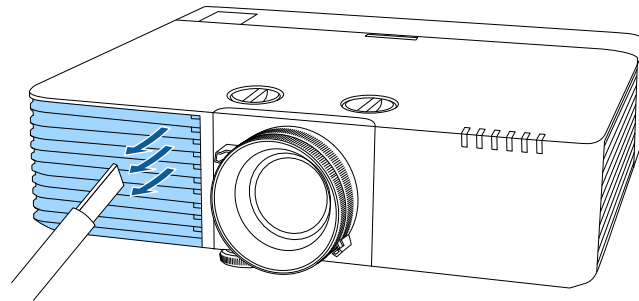

3. Turn the projector upside down.

4. Loosen the screws and remove the air filter cover.

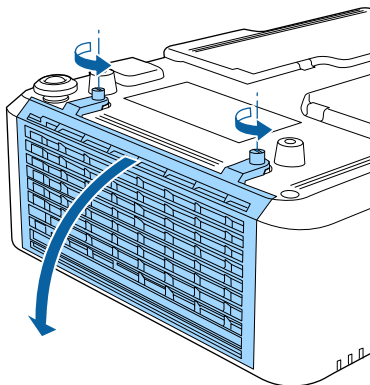

5. Pull the air filter out of the projector.

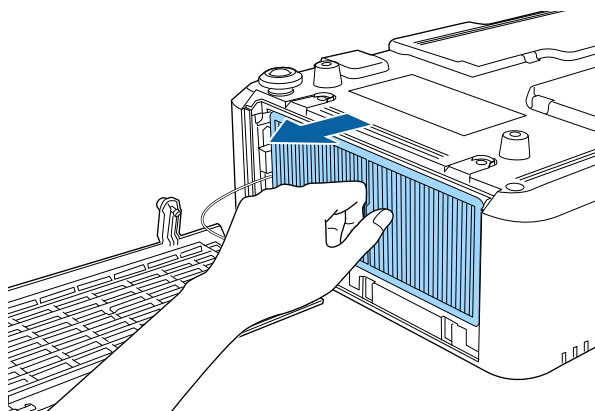

6. Tap each side of the air filter 4 to 5 times to shake off any excess dust.

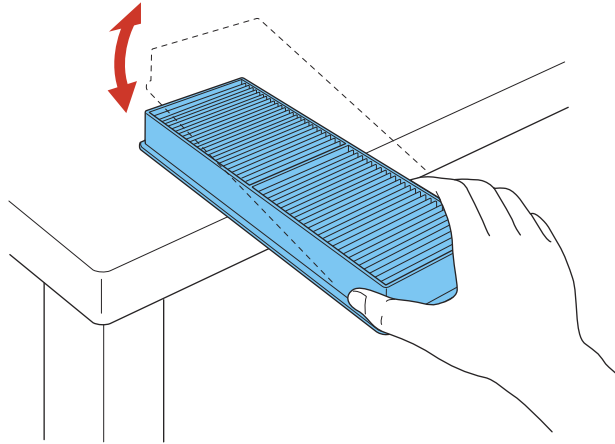

Caution: Do not use excessive force when tapping the air filter, or it may crack and become unusable. Do not rinse the air filter in water, or use any detergent or solvent to clean it. Do not use canned air; the gases may leave a residue, or push dust and debris into the projector's optics or other sensitive areas.

7. Vacuum the front of the air filter (the side with the tabs) to remove any remaining dust.

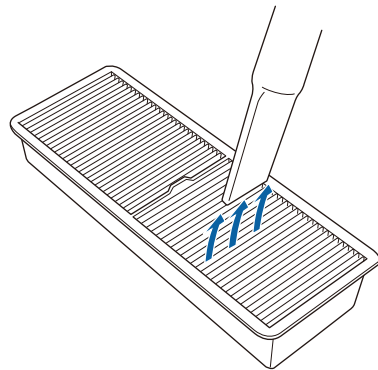

Note: If dust is difficult to remove or the air filter is damaged, replace the air filter.

8. Place the air filter back in the projector as shown.

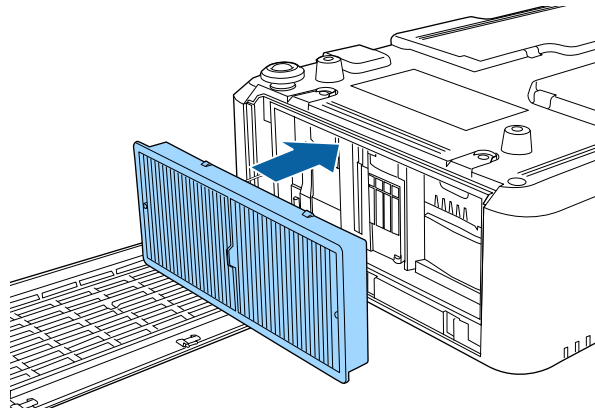

9. Replace the air filter cover and tighten the screws as shown.

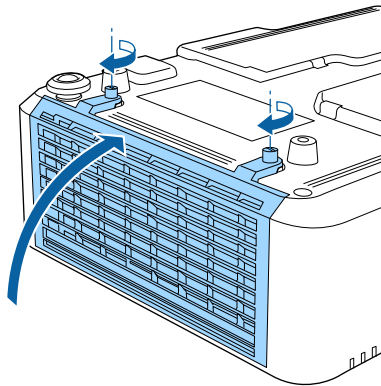

Parent topic: [Air Filter and Vent Maintenance](#)

Related tasks

[Turning Off the Projector](#)

Replacing the Air Filter

You need to replace the air filter in the following situations:

- After cleaning the air filter, you see a message telling you to clean or replace it
- After cleaning the air filter, the projector's Filter light continues to flash orange
- The air filter is torn or damaged

You can replace the air filter while the projector is mounted to the ceiling or placed upside-down on a table.

1. Turn off the projector and unplug the power cord.
2. Loosen the screws and remove the air filter cover.

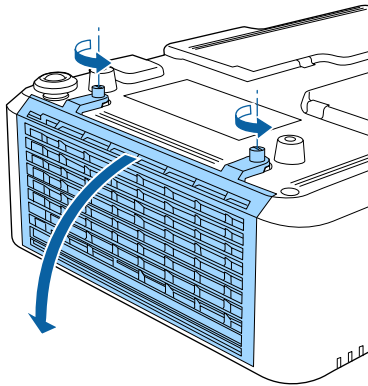

3. Pull the air filter out of the projector.

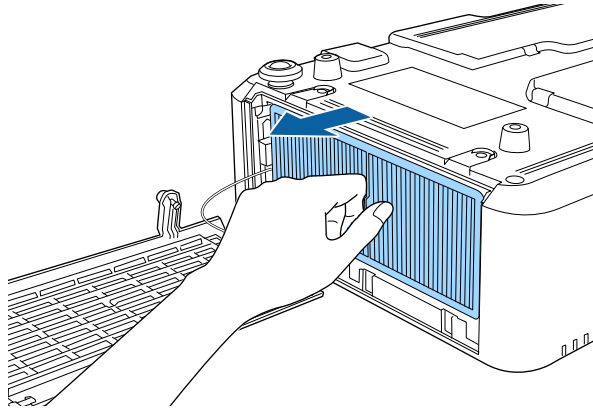

Note: Air filters contain polypropylene. Dispose of used air filters according to local regulations.

4. Place the new air filter in the projector as shown.

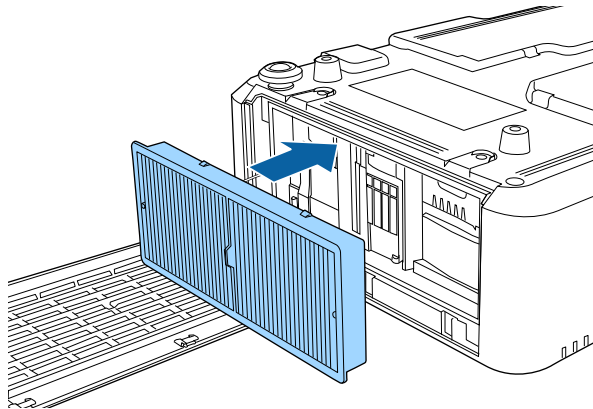

5. Replace the air filter cover and tighten the screws as shown.

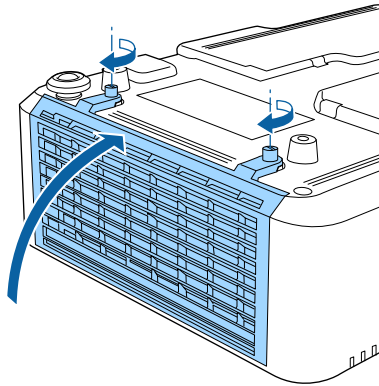

Parent topic: [Air Filter and Vent Maintenance](#)

Related references

[Optional Equipment and Replacement Parts \(U.S. and Canada\)](#)

[Optional Equipment and Replacement Parts \(Latin America\)](#)

Related tasks

[Turning Off the Projector](#)

Replacing the Remote Control Batteries

The remote control uses two AA manganese or alkaline batteries. Replace the batteries as soon as they run out.

Caution: Use only the type of batteries specified in this manual. Do not install batteries of different types, or mix new and old batteries.

1. Remove the battery cover as shown.

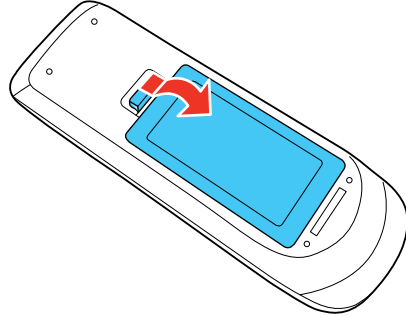

2. Remove the old batteries.

Warning: If the battery fluid has leaked, wipe it away with a soft cloth and avoid getting the fluid on your hands. If it gets on your hands, wash them immediately to avoid injury.

3. Insert the batteries with the + and – ends facing as shown.

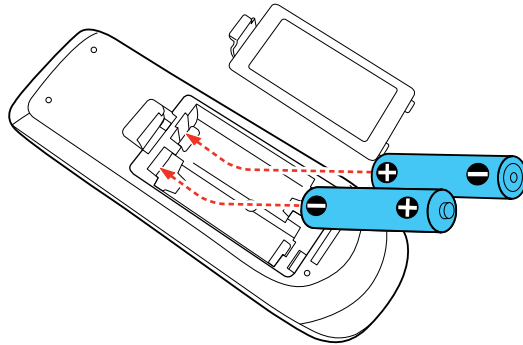

Warning: Make sure the batteries are inserted in the correct positions. If the batteries are not inserted correctly, they could explode or leak, causing a fire, injury, or damage to the product.

4. Replace the battery cover and press it down until it clicks into place.

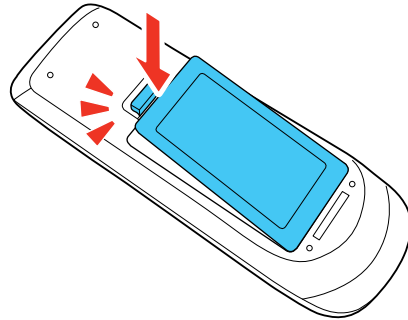

Warning: Dispose of used batteries according to local regulations. Do not expose batteries to heat or flame. Keep batteries out of the reach of children; they are choking hazards and are very dangerous if swallowed.

Parent topic: [Projector Maintenance](#)

Transporting the Projector

The projector contains precision parts, some of which are glass. Follow these guidelines to transport, ship, or store the projector safely:

- Remove any equipment connected to the projector.
- Center the lens position using the vertical and horizontal lens shift dials until they click (PowerLite EB-L530U/EB-L630U/EB-L630SU/EB-L635SU/EB-L730U/EB-L735U).

Caution: If you transport the projector when the lens is not centered, the lens shift mechanism may be damaged.

- Attach the protective lens cover that was included with the projector.
- When transporting the projector a long distance or as checked luggage, pack it in a firm box with cushioning around it and mark the box "Fragile."
- When shipping the projector for repairs, place it in its original packing materials, if possible, or use equivalent materials with cushioning around the projector. Mark the box "Fragile."

Note: Epson shall not be liable for any damages incurred during transportation.

Parent topic: [Maintaining and Transporting the Projector](#)

Related tasks

[Adjusting the Image Position Using Lens Shift](#)

Updating the Firmware

You can update the projector's firmware using a USB storage device or a computer and a USB cable.

If a firmware update is available for your product, you can select the **Firmware Update** option in the projector's Initial/All Settings menu. The projector enters firmware update mode and is ready to perform a firmware update. If a firmware update file is not found, the projector enters standby mode.

You can download your firmware update file from your product's support page or use the Epson Projector Management software to check for firmware updates for your product.

[Updating Projector Firmware Using a USB Storage Device](#)

[Updating Projector Firmware Using a Computer and USB Cable](#)

Parent topic: [Maintaining and Transporting the Projector](#)

Related references

[Additional Projector Software and Manuals](#)

Updating Projector Firmware Using a USB Storage Device

You can update the projector's firmware using a USB storage device.

1. Download the projector firmware file from the Epson support website. Make sure it is the correct firmware file for your model.
2. Copy the downloaded firmware file onto the root (top) folder of the USB storage device.

Note: Do not rename the firmware file. The USB device should be completely empty except for the firmware file and should be formatted in FAT format.

3. Turn on the projector.
4. Connect the USB storage device to the projector's **USB-A** port.
5. Press the **Menu** button, select **Initial/All Settings > Firmware Update** and press **↵Enter**.
6. Select **Yes** to start the firmware update.

Note: Do not disconnect the power cable or remove the USB storage device while the firmware is updating.

While the firmware is updating, all of the status indicators on the projector start flashing. After the update is complete, the projector enters standby mode. If the **Direct Power On** setting is enabled, the projector restarts automatically.

After the update is complete, check the **Version** setting in the **Management > Information** menu to confirm that the firmware was updated successfully.

Parent topic: [Updating the Firmware](#)

Related references

[Where to Get Help \(U.S. and Canada\)](#)

[Where to Get Help \(Latin America\)](#)

[Initial Settings and Reset Options - Initial/All Settings Menu](#)

[Administration Settings - Management Menu](#)

Related tasks

[Connecting to a USB Device](#)

Updating Projector Firmware Using a Computer and USB Cable

You can update the projector firmware using a computer and a USB cable.

Note: You need a USB Type A to USB Type B cable.

Your computer must be running one of the following operating systems when updating firmware:

- Windows 8.1 (32- and 64-bit)
 - Windows 10 (32- and 64-bit)
 - macOS 10.13.x (64-bit)
 - macOS 10.14.x (64-bit)
 - macOS 10.15.x (64-bit)
 - macOS 11.x (64-bit)
1. Download the projector firmware file from the Epson support website. Make sure it is the correct firmware file for your model.
 2. Turn on the projector.
 3. Connect the USB cable to the computer's USB port and to the projector's **Service** port.
 4. Press the **Menu** button, select **Initial/All Settings > Firmware Update** and press **Enter**.

5. Select **Yes** to start the firmware update.

Note: Do not disconnect the power cable or remove the USB cable while the firmware is updating.

All of the status indicators on the projector start flashing, and the projector enters firmware update mode. The projector appears as a removable drive on the connected computer.

6. Copy the downloaded firmware file onto the root (top) directory of the projector's removable drive.

Note: Do not rename the firmware file.

7. Safely remove the projector's removable drive from the computer, then disconnect the USB cable from the projector.

The firmware update starts.

While the firmware is updating, the status indicators on the projector start flashing. After the update is complete, the projector enters standby mode. If **Direct Power On** is enabled, the projector restarts automatically.

After the update is complete, check the **Version** setting in the **Management > Information** menu to confirm that the firmware was updated successfully.

Parent topic: [Updating the Firmware](#)

Related references

[Where to Get Help \(U.S. and Canada\)](#)

[Where to Get Help \(Latin America\)](#)

[Initial Settings and Reset Options - Initial/All Settings Menu](#)

[Administration Settings - Management Menu](#)

Related tasks

[Connecting to a USB Device](#)

Solving Problems

Check the solutions in these sections if you have any problems using the projector.

[Projection Problem Tips](#)

[Projector Light Status](#)

[Viewing Projector Status Information](#)

[Using the Projector Menu Displays](#)

[Solving Image or Sound Problems](#)

[Solving Projector or Remote Control Operation Problems](#)

[Solving Network Problems](#)

[Solutions to Problems Using Content Playback](#)

[Solutions to HDMI Link Problems](#)

[Where to Get Help \(U.S. and Canada\)](#)

[Where to Get Help \(Latin America\)](#)

Projection Problem Tips

If the projector is not working properly, try turning it off and unplugging it. Then plug it back in and turn it on.

If this does not solve the problem, check the following:

- The lights on the projector may indicate what the problem is.
- The solutions in this manual can help you solve many problems.

If none of these solutions help, you can contact Epson for technical support.

Parent topic: [Solving Problems](#)

Related references

[Projector Light Status](#)

[Where to Get Help \(U.S. and Canada\)](#)

[Where to Get Help \(Latin America\)](#)

Related tasks

[Turning On the Projector](#)

[Turning Off the Projector](#)

Projector Light Status

The lights on the projector indicate the projector status and let you know when a problem occurs. Check the status and color of the lights and look for a solution in the table here.

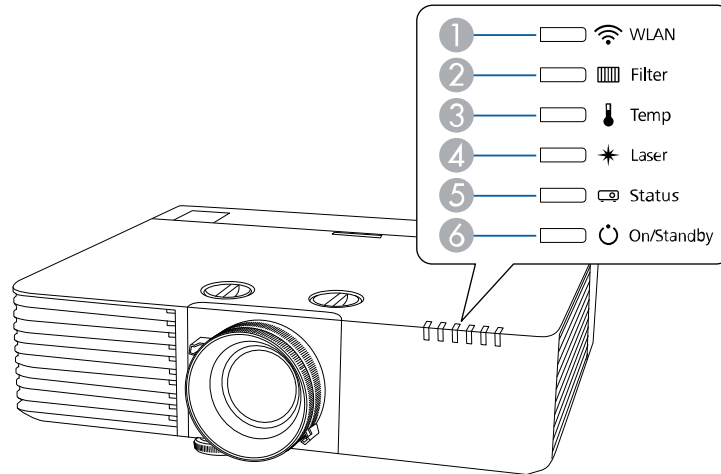

- 1 WLAN (wireless LAN) light
- 2 Filter light
- 3 Temp (temperature) light
- 4 Laser light
- 5 Status light
- 6 On/Standby (power) light

On/Standby (power) light	Status light	Laser light	Temp light	Filter light	Status and solution
Blue	Off	Off	Off	Off	Standby, sleep mode, or network monitoring and control
Blue	Flashing blue	Off	Off	Off	Warming up or cooling down. Wait for about 30 seconds for an image to appear. All control panel buttons are disabled.

On/Standby (power) light	Status light	Laser light	Temp light	Filter light	Status and solution
Blue	Blue	Off	Off	Off	Normal operation.
Flashing blue	Off	Off	Off	Off	Preparing for network monitoring or quick startup mode. All features are disabled.
Off	Flashing blue	Flashing orange	Off	Off	Internal error. Turn off the projector, unplug it from the electrical outlet, and contact Epson for help.
Off	Flashing blue	Off	Flashing orange	Off	A fan or sensor has a problem. Turn the projector off, unplug it, and contact Epson for help.
Off	Flashing blue	Off	Orange	Off	<p>Projector has overheated and turned off. Leave it turned off to cool down for five minutes.</p> <ul style="list-style-type: none"> • Make sure that the vents and air filter are not clogged with dust or obstructed by nearby objects. • Make sure the room temperature is not too hot. • Clean or replace the air filter. • If operating the projector at high altitude, turn on High Altitude Mode. • If the problem persists, unplug the projector and contact Epson for help.

On/Standby (power) light	Status light	Laser light	Temp light	Filter light	Status and solution
Off	Flashing blue	Orange	Off	Off	<p>Laser has a problem.</p> <ul style="list-style-type: none"> • Make sure that the vents and air filter are not clogged with dust or obstructed by nearby objects. • Clean or replace the air filter. • If the problem persists, unplug the projector and contact Epson for help.
Off	Flashing blue	Off	Off	Orange	<p>Low air flow through the projector.</p> <ul style="list-style-type: none"> • Make sure that the vents and air filter are not clogged with dust or obstructed by nearby objects. • Clean or replace the air filter. • If the problem persists, unplug the projector and contact Epson for help.
Varies	Varies	Flashing orange	Varies	Varies	<p>The projector is unable to maintain constant brightness. The Maintain Brightness setting is disabled.</p>
Varies	Flashing blue	Flashing orange	Varies	Varies	<p>Refresh mode is in progress.</p>
Flashing blue	Varies	Varies	Flashing orange	Varies	<p>High temperature warning. If the temperature gets too high, projection automatically stops.</p> <ul style="list-style-type: none"> • Make sure that the vents and air filter are not clogged with dust or obstructed by nearby objects. • Make sure the room temperature is not too hot. • Clean or replace the air filter.

On/Standby (power) light	Status light	Laser light	Temp light	Filter light	Status and solution
Flashing blue	Varies	Flashing orange	Varies	Varies	Laser warning. Turn the projector off, unplug it, and contact Epson for help.
Flashing blue	Varies	Varies	Varies	Orange	Low air flow through the air filter. <ul style="list-style-type: none"> • Make sure that the vents and air filter are not clogged with dust or obstructed by nearby objects. • Clean or replace the air filter. • If the problem persists, unplug the projector and contact Epson for help.
Varies	Varies	Varies	Varies	Flashing orange	It is time to clean the air filter.
		Flashing orange (fast)	Flashing orange (fast)		The batch setup file may be corrupt or the USB flash drive may not be connected correctly. Disconnect the USB flash drive, unplug the projector's power cord, and try again.
Flashing blue (fast)	Flashing blue (fast)	Flashing orange (fast)	Flashing orange (fast)		Writing the settings may have failed and an error may have occurred in the projector's firmware. Turn off the projector and unplug it from the electrical outlet. Contact Epson for help.

Note: If the lights display a pattern not listed in the table above, turn the projector off, unplug it, and contact Epson for help.

Wireless LAN status

WLAN light	Status and solution
Blue	Wireless LAN is available
Flashing blue (fast)	Connecting to a device
Flashing blue (slow)	An error occurred. Turn off the projector, then restart it.
Off	Wireless LAN is not available. Make sure the wireless LAN settings are correct.

Parent topic: [Solving Problems](#)

Related references

[Where to Get Help \(U.S. and Canada\)](#)

[Where to Get Help \(Latin America\)](#)

[Administration Settings - Management Menu](#)

[Feature Settings - Operation Menu](#)

Related tasks

[Cleaning the Air Filter](#)

[Replacing the Air Filter](#)

Viewing Projector Status Information

You can monitor the projector's status and view error information through the menu system.

1. Turn on the projector.
2. Press the **Menu** button on the control panel or remote control.
3. Select the **Management** menu and press **Enter**.
4. Select **Display Logs > Display Status** and press **Enter**.
5. Press the left or right arrow button to view different categories of information.
 - **Status Information:** the projector's operating status
 - **Source:** input signal information
 - **Signal Information:** input digital signal information
 - **Network Wired:** wired LAN settings
 - **Network Wireless:** wireless LAN settings

- **Maintenance:** operating time for the projector and light source
- **Version:** projector's firmware version

[Projector Status Display Messages](#)

Parent topic: [Solving Problems](#)

Projector Status Display Messages

Categories on the status display screens let you view information about the projector and its operation.

Status Information category

Information	Description
System	See the System status information table at the end of this topic
Source	Displays the source currently being used
On-Screen Display	Displays the settings for on-screen displays. When turned off, menus or messages are not displayed on the projected images
A/V Mute	Displays the A/V Mute status
Intake Air Temp	Displays the air intake temperature
Internal Temp Lv	Displays the projector's internal temperature
Laser Status	Displays the operating status of the light source

Source category

Information	Description
Source	Displays the source currently being used
Resolution	Displays the resolution of the current input signal
Color Space	Displays the color space of the current input signal
H-Frequency	Displays the horizontal frequency of the current input signal
V-Frequency	Displays the vertical frequency of the current input signal

Information	Description
Sync Polarity	Displays the sync polarity
Sync Mode	Displays the sync type
Detected Mode	Displays the detected mode of the current input signal
Video Range	Displays the video range of the projector

Signal Information category

Information	Description
5V Detect	Displays the detection results of 5V signals
TMD5 Clock	Displays the TMD5 frequency of the current input signal
H-Frequency	Displays the horizontal frequency of the current input signal
V-Frequency	Displays the vertical frequency of the current input signal
Stable Time	Displays the amount of operating time since the input source was determined
HDCP Status	Displays the HDCP status
HDCP Ver	Displays the HDCP version
AVI VIC	Displays the VIC information (AVI) of the current input signal
AVI Checksum	Displays the checksum result for AVI
AVI Sampling Str	Displays the color sampling for AVI
Signal Mode	Displays the signal mode
HDBaseT Level	Displays the image signal from the HDBaseT port

Network Wired category

Information	Description
Projector Name	Displays the name used to identify the projector when connected to a network
Connection Mode	Displays the connection path for the LAN
DHCP	Displays the DHCP display settings
IP Display	Displays the IP address display settings
IP Address	Displays the IP address
MAC Address	Displays the MAC address

Network Wireless category

Information	Description
Projector Name	Displays the name used to identify the projector when connected to a network
Connection Mode	Displays the connection mode to use when connecting the projector and a computer over a wireless LAN
SSID	Displays the SSID
DHCP	Displays the DHCP settings
IP Display	Displays the IP address display settings
IP Address	Displays the IP address
MAC Address	Displays the MAC address
Security	Displays the security settings
Antenna Level	Displays the reception status for Wi-Fi

Maintenance category

Information	Description
Operation Time	Displays the projector's total operation time
Laser Op. Time	Displays the laser operating time for each Light Source Mode setting

Version category

Information	Description
Serial No.	Displays the projector's serial number
Main	Display the projector's firmware version information
HDBaseT	

System status information

Status	Description
OK	The projector is in normal operating mode
Warm-up	The projector is warming up
Standby	The projector is in standby mode
Cool Down	The projector is cooling down
Temp Error	A high temperature error occurred
Fan Error	A fan error occurred
Sensor Error	A sensor error occurred
Power Error	A power error occurred
Internal Error	An internal error occurred
Airflow Error	A filter airflow error occurred
Temp Warning	A high temperature warning occurred
Internal Warning	A warning regarding the internal system occurred
Airflow Decline	A low airflow error occurred
Power Warning	A power warning occurred
Clean Filter	An air filter notice occurred; clean the air filter
Laser Error	A laser error has occurred
Laser Warning	A laser warning has occurred
Temp Error FE	A laser error has occurred because the laser temperature is too high

Status	Description
Temp Warning FE	A laser warning has occurred because the laser temperature is too high

Parent topic: [Viewing Projector Status Information](#)

Using the Projector Menu Displays

The projector displays descriptions in the menu system to help you navigate the projector's settings. The descriptions appear on the right side of the screen as you scroll the menu settings.

Parent topic: [Solving Problems](#)

Solving Image or Sound Problems

Check the solutions in these sections if you have any problems with projected images or sound.

[Solutions When No Image Appears](#)

[Solutions When "No Signal" Message Appears](#)

[Solutions When No Image Appears on an External Monitor](#)

[Solutions When "Not Supported" Message Appears](#)

[Solutions When Only a Partial Image Appears](#)

[Solutions When the Image is Not Rectangular](#)

[Solutions When the Image Contains Noise or Static](#)

[Solutions When the Image is Fuzzy or Blurry](#)

[Solutions When the Image Brightness or Colors are Incorrect](#)

[Solutions When an Afterimage Remains On the Projected Image](#)

[Solutions to Sound Problems](#)

[Solutions to PC Free Problems](#)

Parent topic: [Solving Problems](#)

Solutions When No Image Appears

If no image appears, try the following solutions:

- Make sure the lens cap is off.
- Check the status lights to confirm the projector is operating normally.

- Make sure all necessary cables are securely connected and the power is on for the projector and connected video sources.
- If you connected your video source to the **Computer2/Monitor Out** port, make sure you set the **Monitor Out Port** setting to **Computer2**.
- Press the projector's power button to wake it from standby or sleep mode. Also see if your connected computer is in sleep mode or displaying a blank screen saver.
- If the projector does not respond when you press any buttons on the projector, an internal error may have occurred in the projector. Contact Epson for help.
- Adjust the **Brightness** setting on the Image menu.
- Adjust the brightness of your projector's light source.
- Check the Display menu to make sure the **Messages** setting is set to **On**.
- If the projector does not respond when you press the control panel buttons, the buttons may be locked. Unlock the buttons.
- For images projected with Windows Media Center, reduce the screen size from full screen mode.
- For images projected from applications using Windows DirectX, turn off DirectX functions.
- The projector may not be able to project copyrighted videos that you play back on a computer. For details, see the manual supplied with your computer.

Parent topic: [Solving Image or Sound Problems](#)

Related references

[Input Signal Settings - Signal I/O Menu](#)

[Display Settings - Display Menu](#)

[Image Quality Settings - Image Menu](#)

Related tasks

[Adjusting the Projector's Brightness Level](#)

Solutions When "No Signal" Message Appears

If the "No Signal" message appears, try the following solutions:

- Press the **Source Search** button and wait a few seconds for an image to appear.
- Turn on the connected computer or video source, and press its play button to begin your presentation, if necessary.
- Check the connection from the projector to your video sources.

- If you are projecting from a laptop computer, make sure it is set up to display on an external monitor.
- If necessary, turn the projector and the connected computer or video source off and then on again.
- If you are projecting from an HDMI source, replace the HDMI cable with a shorter one.
- Try a different video cable.
- If the other solutions do not solve the problem, reset all of the projector settings using the options on the **Initial/All Settings** menu.

[Displaying From a PC Laptop](#)

[Displaying From a Mac Laptop](#)

Parent topic: [Solving Image or Sound Problems](#)

Related concepts

[Projector Connections](#)

Related references

[Initial Settings and Reset Options - Initial/All Settings Menu](#)

Related tasks

[Selecting an Image Source](#)

Displaying From a PC Laptop

If you see the "No Signal" message when you display from a PC laptop, you need to set up the laptop to display on an external monitor.

1. Hold down the laptop's **Fn** key and press the key labeled with a monitor icon or **CRT/LCD**. (See your laptop manual for details.) Wait a few seconds for an image to appear. To display on both the laptop's monitor and the projector, try pressing the same keys again.

Note: On Windows 7 or later, hold down the Windows key and press **P** at the same time, then click **Duplicate**.

2. If the same image is not displayed by the laptop and projector, check the Windows **Display** utility to make sure the external monitor port is enabled and extended desktop mode is disabled. (See your computer or Windows manual for instructions.)
3. If necessary, check your video card settings and set the multiple display option to **Clone**, **Mirror**, or **Duplicate**.

Parent topic: [Solutions When "No Signal" Message Appears](#)

Displaying From a Mac Laptop

If you see the "No Signal" message when you display from a Mac laptop, you need to set up the laptop for mirrored display. (See your laptop manual for details.)

1. Open the **System Preferences** utility and select **Displays**, **Display**, or **Color LCD**.
2. Click the **Arrange** or **Arrangement** tab.
3. Select the **Mirror Displays** checkbox.

Parent topic: [Solutions When "No Signal" Message Appears](#)

Solutions When No Image Appears on an External Monitor

If no image appears on a connected external monitor, try the following solutions:

- Make sure your external monitor's cable is connected to the monitor and to the projector's **Monitor Out** port.
- Make sure you set the **Monitor Out Port** setting to **Monitor Out**.

Parent topic: [Solving Image or Sound Problems](#)

Related references

[Input Signal Settings - Signal I/O Menu](#)

Solutions When "Not Supported" Message Appears

If the "Not Supported" message appears, try the following solutions:

- Make sure the correct input signal is selected on the Signal I/O menu.
- Make sure the computer's display resolution does not exceed the projector's resolution and frequency limit. If necessary, select a different display resolution for your computer. (See your computer manual for details.)
- If you are projecting from an HDMI source, change the **HDMI IN EQ Level** setting in the projector's Signal I/O menu. Follow the on-screen instructions. You may need to restart the projector.
- If you are projecting using a thumb-sized media streaming device, set the **HDMI IN EQ Level** to **Auto** in the projector's Signal I/O menu.

Parent topic: [Solving Image or Sound Problems](#)

Related references

[Input Signal Settings - Signal I/O Menu](#)

Solutions When Only a Partial Image Appears

If only a partial computer image appears, try the following solutions:

- For VGA connections, press the **Auto** button on the remote control to optimize the image signal.
- Make sure you selected the correct **Screen Type** setting in the projector's Installation menu for the screen you are using. If there are margins between the edge of the image and the projected screen frame, use the **Screen Position** setting to adjust the position of the image.
- Make sure the **Scale** setting in the Image menu is turned off.
- Make sure the **Resolution** setting in the Image menu is set correctly for the input signal.
- Try adjusting the image position using the **Position** setting in the Image menu.
- If you adjusted the image size using the **Digital Zoom** setting in the Installation menu, use the **Image Shift** setting to adjust the image position (PowerLite EB-L630SU/EB-L635SU).
- Try adjusting the image position using the **Screen Position** menu setting.
- Press the **Aspect** button on the remote control to select a different image aspect ratio.
- Check the **Blanking** setting in the Installation menu.
- If you zoomed into or out of the image using the **E-Zoom** buttons, press the **Esc** button until the projector returns to a full display (PowerLite EB-L530U/EB-L630U/EB-L630SU/EB-L635SU/EB-L730U/EB-L735U).
- If you zoomed into or out of the image using the **E-Zoom** buttons, press the **Default** button until the projector returns to a full display (PowerLite EB-L520U).
- Check your computer display settings to disable dual display and set the resolution within the projector's limits. (See your computer manual for details.)
- Check the resolution assigned to your presentation files to see if they are created for a different resolution than you are projecting in. (See your software help for details.)
- Make sure you selected the correct **Projection** setting in the Installation menu.
- If you are projecting in **Content Playback** mode, make sure you are using the correct **Overlay Effect** setting in the Operation > Content Playback menu.

Parent topic: [Solving Image or Sound Problems](#)

Related references

[Image Quality Settings - Image Menu](#)

[Installation Settings - Installation Menu](#)

[Installation Settings - Installation Menu](#)

[Feature Settings - Operation Menu](#)

Related tasks

[Adjusting the Image Position Using Image Shift](#)

[Adjusting the Image Position Using Lens Shift](#)

[Resizing the Image using Digital Zoom](#)

[Changing the Image Aspect Ratio](#)

[Adjusting the Image Resolution](#)

[Setting the Screen Type](#)

Solutions When the Image is Not Rectangular

If the projected image is not evenly rectangular, try the following solutions:

- Place the projector directly in front of the center of the screen, facing it squarely, if possible.
- If you are mounting the projector from the ceiling, use the adjustment controls on the mount at the time of installation.
- Try to fix the image using lens shift before adjusting the **Keystone** setting.
- Adjust the **Quick Corner** setting to correct the image shape.
- Adjust the **Arc Correction** setting to correct the image shape projected on a curved surface.
- Adjust the **Point Correction** setting to correct slight distortion that affects a portion of the screen.

Parent topic: [Solving Image or Sound Problems](#)

Related tasks

[Correcting Image Shape with H/V-Keystone](#)

[Correcting Image Shape with Quick Corner](#)

[Correcting Image Shape with Arc Correction](#)

[Correcting Image Shape with Point Correction](#)

Solutions When the Image Contains Noise or Static

If the projected image seems to contain electronic interference (noise) or static, try the following solutions:

- Check the cables connecting your computer or video source to the projector. They should be:
 - Separated from the power cord to prevent interference
 - Securely connected at both ends

- Not connected to an extension cable
- Make sure you selected the correct **Signal Format** or **EDID** settings in the projector's Signal I/O menu, if available for your image source.
- Adjust the **Noise Reduction**, **MPEG Noise Reduction**, and **Deinterlacing** settings in the projector's Image menu.
- If available for your video source, select **Auto** as the **Resolution** setting in the Image menu.
- Select a computer video resolution and refresh rate that are compatible with the projector.
- If you are projecting from a computer using a VGA cable, press the **Auto** button on the remote control to automatically adjust the tracking and sync. If the problem remains, display a uniformly patterned image on the screen and manually adjust the **Tracking** and **Sync** settings.
- If you adjusted the image shape using the projector controls, try decreasing the **Sharpness** setting to improve image quality.
- If you connected an extension power cable, try projecting without it to see if it caused interference in the signal.

Parent topic: [Solving Image or Sound Problems](#)

Related references

[Image Quality Settings - Image Menu](#)

[Input Signal Settings - Signal I/O Menu](#)

[Supported Video Display Formats](#)

Solutions When the Image is Fuzzy or Blurry

If the projected image is fuzzy or blurry, try the following solutions:

- Adjust the image focus.
- Clean the projector lens.

Note: To avoid condensation on the lens after bringing the projector in from a cold environment, let the projector warm up to room temperature before using it.

- Position the projector close enough to the screen.
- Position the projector so the keystone adjustment angle is not so wide that it distorts the image.
- Adjust the **Sharpness** setting to improve image quality.

- If you are projecting from a computer using a VGA cable, press the **Auto** button on the remote control to automatically adjust the tracking and sync. If any bands or overall blurriness remain, display a uniformly patterned image on the screen and manually adjust the **Tracking** and **Sync** settings.
- If you are projecting from a computer, use a lower resolution or adjust the computer's resolution to match the projector's native resolution, if possible.

Parent topic: [Solving Image or Sound Problems](#)

Related references

[Image Quality Settings - Image Menu](#)

[Input Signal Settings - Signal I/O Menu](#)

[Supported Video Display Formats](#)

[Projection Distance](#)

Related tasks

[Cleaning the Lens](#)

Solutions When the Image Brightness or Colors are Incorrect

If the projected image is too dark or light, or the colors are incorrect, try the following solutions:

- Press the **Color Mode** button on the remote control to try different color modes for the image and environment.
- Check your video source settings.
- Adjust the available settings on the Image menu for the current input source, such as **Brightness**, **Contrast**, **Tint**, **Color Saturation**, and **RGBCMY**. RGBCMY should be set by a professional color calibrator using specialized color calibration tools in a controlled lighting environment.
- Make sure you selected the correct **Signal Format** or **EDID** setting in the Signal I/O menu, if available for your video source.
- Make sure all the cables are securely connected to the projector and your video device. If you connected long cables, try connecting shorter cables.
- Position the projector close enough to the screen.
- Make sure you have run the **Light Source Calibration** in the Management menu recently. If using multiple projectors, perform the calibration on all projectors to ensure a consistent image quality.

Parent topic: [Solving Image or Sound Problems](#)

Related references

[Image Quality Settings - Image Menu](#)

[Input Signal Settings - Signal I/O Menu](#)

[Supported Video Display Formats](#)
[Image Quality Settings - Image Menu](#)

Related tasks

[Changing the Color Mode](#)
[Running Light Source Calibration](#)

Solutions When an Afterimage Remains On the Projected Image

If you see an afterimage in the projected image, select **Refresh Mode > Start** in the Management menu.

Parent topic: [Solving Image or Sound Problems](#)

Related references

[Administration Settings - Management Menu](#)

Solutions to Sound Problems

If there is no sound when you expect it or the volume is too low or high, try the following solutions:

- Adjust the projector's volume settings.
- Press the **A/V Mute** button on the control panel or remote control to resume video and audio if they were temporarily stopped.
- Check your computer or video source to make sure the volume is turned up and the audio output is set for the correct source.
- Check the cable connection between the projector and your video source.
- Try disconnecting and reconnecting the audio cable.
- If you do not hear sound from an HDMI source, set the connected device to PCM output.
- Make sure any connected audio cables are labeled "No Resistance."
- If you are using a Mac and you do not hear sound from an HDMI source, make sure your Mac supports audio through the HDMI port. If not, you need to connect an audio cable.
- If you want to use a connected audio source when the projector isn't projecting any images, set the **Quick Startup** option in the Operation menu to **Off** and make sure the **A/V Output** setting in the Signal I/O menu is set to **Always On**.
- If the volume for the computer is set to the minimum while the projector's volume is set to maximum, the sound level may be mixed. Turn up the computer's volume and decrease the projector's volume (when using Epson iProjection [Windows/Mac]).

- Make sure the **Audio Output** and **HDMI Audio Output** options are set to the correct audio port for your video device.
- If you turn the projector on immediately after turning it off, the cooling fans may run at high speed momentarily and cause an unexpected noise. This is normal.

Parent topic: [Solving Image or Sound Problems](#)

Related references

[Input Signal Settings - Signal I/O Menu](#)

[Feature Settings - Operation Menu](#)

Related tasks

[Controlling the Volume with the Volume Buttons](#)

[Shutting Off the Picture and Sound Temporarily](#)

[Connecting to External Speakers](#)

Solutions to PC Free Problems

If you are having problems with the PC Free feature on your projector, try the following solutions:

- If any file names are longer than the display area or include unsupported symbols, the displayed file names are shortened or changed in PC Free. To avoid this, shorten or change the file name on the USB drive.
- If you are using a USB device with a slow transfer speed, you may not be able to project movies correctly.
- You cannot play movies saved with a movie codec other than H.264 and H.265. (H.265 only supports Main Profile.)
- You cannot play audio saved with an audio codec other than LPCM and AAC-LC.

Parent topic: [Solving Image or Sound Problems](#)

Related references

[Supported PC Free File Types](#)

[PC Free Precautions](#)

Solving Projector or Remote Control Operation Problems

Check the solutions in these sections if you have problems operating the projector or remote control.

[Solutions to Projector Power or Shut-Off Problems](#)

[Solutions to Remote Control Problems](#)

[Solutions to Password Problems](#)

[Solutions When a Battery Message Appears](#)

Parent topic: [Solving Problems](#)

Solutions to Projector Power or Shut-Off Problems

If the projector does not come on when you press the power button or it shuts off unexpectedly, try the following solutions:

- Make sure the power cord is securely connected to the projector and to a working electrical outlet.
- The projector's buttons may be locked for security. Unlock the buttons or use the remote control to turn on the projector.
- If the projector's laser shuts off unexpectedly, it may have entered standby mode after a period of inactivity. Press the power button to wake the projector and adjust the **Sleep Mode** setting to change the sleep interval.
- If the projector's light source turns off unexpectedly, the A/V mute timer may be enabled. Select **Off** as the **A/V Mute Timer** setting.
- If the power button on the remote control does not turn on the projector, check its batteries and make sure the **Remote Receiver** setting is turned on in the projector's menu, if available.
- The power cord may be defective. Try another power cord. If that doesn't work, disconnect the cord and contact Epson.
- The cooling fans may run in standby status depending on the projector settings. Also, when the projector wakes from standby status, the fans may cause an unexpected noise. This is not a malfunction.

Parent topic: [Solving Projector or Remote Control Operation Problems](#)

Related references

[Feature Settings - Operation Menu](#)

[Installation Settings - Installation Menu](#)

[Where to Get Help \(U.S. and Canada\)](#)

[Where to Get Help \(Latin America\)](#)

Related tasks

[Unlocking the Projector's Buttons](#)

[Turning On the Projector](#)

Solutions to Remote Control Problems

If the projector does not respond to remote control commands, try the following solutions:

- Check that the remote control batteries are installed correctly and have power. If necessary, replace the batteries.
- Make sure you are operating the remote control within the reception angle and range of the projector.
- Make sure the projector is not warming up or shutting down.
- Check to see if a button on the remote control is stuck down, causing it to enter sleep mode. Release the button to wake the remote control up.
- Strong fluorescent lighting, direct sunlight, or infrared device signals may be interfering with the projector's remote receivers. Dim the lights or move the projector away from the sun or interfering equipment.
- If available, turn on one of the remote receivers in the projector's menu system, or check if all the remote receivers were turned off.
- If the remote receiver setting is off, press and hold the **Menu** button on the remote for at least 15 seconds to restore the default setting.
- If you assigned an ID number to the remote control to operate multiple projectors, you may need to check or change the ID setting (feature not available with all projectors).
- If you lose the remote control, you can purchase another from an Epson parts distributor.

Parent topic: [Solving Projector or Remote Control Operation Problems](#)

Related references

[Installation Settings - Installation Menu](#)

[Remote Control Operation](#)

Related tasks

[Replacing the Remote Control Batteries](#)

[Setting the Remote Control ID](#)

Solutions to Password Problems

If you cannot enter or remember a password, try the following solutions:

- You may have turned on password protection without first setting a password. Try entering **0000** using the remote control. If you lose the remote control, you cannot enter a password. Order a new one from Epson.

- If you have entered an incorrect password too many times and see a message displaying a request code, write down the code and contact Epson. Do not attempt to enter the password again. Provide the request code and proof of ownership for assistance in unlocking the projector.
- If you set a Epson Web Control password and forgot the user ID or password, try entering the following:
 - User ID: **EPSONWEB**
 - Default password: **admin**
- If you set a Remote password (in Epson Web Control) and forgot the user ID or password, try entering the following:
 - User ID: **EPSONREMOTE**
 - Default password: **guest**

Parent topic: [Solving Projector or Remote Control Operation Problems](#)

Related references

[Where to Get Help \(U.S. and Canada\)](#)

[Where to Get Help \(Latin America\)](#)

Related tasks

[Setting a Password](#)

[Selecting Password Security Types](#)

[Entering a Password to Use the Projector](#)

Solutions When a Battery Message Appears

If you see a message telling you that the battery that saves your clock settings is running low, contact Epson for help.

Parent topic: [Solving Projector or Remote Control Operation Problems](#)

Related references

[Where to Get Help \(U.S. and Canada\)](#)

[Where to Get Help \(Latin America\)](#)

Solving Network Problems

Check the solutions in these sections if you have problems using the projector on a network.

[Solutions When Wireless Authentication Fails](#)

[Solutions When You Cannot Access the Projector Through the Web](#)

[Solutions When Network Alert E-Mails are Not Received](#)
[Solutions When You Cannot Connect Using Screen Mirroring](#)
[Solutions When the Image Contains Static During Network Projection](#)
[Solutions When the Image or Sound Contains Static During Screen Mirroring](#)

Parent topic: [Solving Problems](#)

Solutions When Wireless Authentication Fails

If you cannot authenticate a wireless connection, try the following solutions:

- If the wireless settings are correct, but authentication fails, you may need to update the **Date & Time** settings in the Management menu, if available.
- Check the **Security** settings and passphrase in the Network menu.
- If the access point security is WPA3-EAP, change the access point setting to **WPA2/WPA3-EAP**.

Parent topic: [Solving Network Problems](#)

Related references

[Network Settings - Network Menu](#)

[Administration Settings - Management Menu](#)

Related tasks

[Setting the Date and Time](#)

[Setting Up Wireless Network Security](#)

Solutions When You Cannot Access the Projector Through the Web

If you are unable to access the projector through a web browser, make sure you are using the correct ID and password, which are case sensitive.

- For the user ID, enter **EPSONWEB**. (You cannot change the user ID.)
- For the password, enter the password set in the projector's Network menu. The default password is **admin**.
- Make sure you have access to the network the projector is on.
- If your Web browser is set up to connect via a proxy server, the **Epson Web Control** screen cannot be displayed. Make settings for a connection without using a proxy server.
- If you set **Standby Mode** to **Communication On** in the projector's Operation menu, make sure the network device is turned on. After turning on the network device, turn on the projector.

Note: The user ID and password are case sensitive.

Parent topic: [Solving Network Problems](#)

Related references

[Feature Settings - Operation Menu](#)

Solutions When Network Alert E-Mails are Not Received

If you do not receive an e-mail alerting you to problems with a projector over the network, try the following solutions:

- Make sure the projector is turned on and connected to the network correctly. (If an error shut down the projector, it cannot send an e-mail.)
- Make sure you set up the projector e-mail alert settings correctly on the projector's Network Mail Notification menu or in the network software.
- Set the **Standby Mode** setting to **Communication On** so the network software can monitor the projector in standby mode. Change the **Port** setting according to your network environment.

Parent topic: [Solving Network Problems](#)

Related references

[Feature Settings - Operation Menu](#)

Related tasks

[Setting Up Projector Network E-Mail Alerts](#)

Solutions When You Cannot Connect Using Screen Mirroring

If you are unable to connect to the projector using Screen Mirroring, try the following solutions:

- Set the **Simple AP** setting to **On**.
- Make sure **On** is selected as the **Screen Mirroring** setting in the projector's Network menu. Try turning the setting off and then on again, if necessary.
- Make sure the **Operation Mode** and **Channel** settings are correct for your mobile environment and try connecting again.
- If you are unable to use two Screen Mirroring sources at the same time, set the **Network > Network Settings > Screen Mirroring > Interrupt Connection** setting to **Off**.
- Make sure the mobile device settings are correct.
- You may not be able to connect immediately after disconnecting from the projector. Wait a while and try connecting again.

- Restart the mobile device.
- If you have previously connected to the projector using Screen Mirroring, the device may have saved the previous connection information. Delete the saved information and connect to the projector from the list of available devices.

Parent topic: [Solving Network Problems](#)

Related references

[Screen Mirroring Restrictions](#)

Solutions When the Image Contains Static During Network Projection

If the projected image contains static during network projection, try the following solutions:

- Check for any obstacles between the access point, the computer, the mobile device, and the projector. If necessary, change their positions to improve communication. Also make sure that they are not too far apart; move them closer together and try to connect again.
- If the wireless connection is slow or your projected image contains noise, check for interference from other equipment, such as a Bluetooth device or microwave. Move the interfering device farther away or expand your wireless bandwidth.
- If the connection speed declines, reduce the number of connected devices.

Parent topic: [Solving Network Problems](#)

Solutions When the Image or Sound Contains Static During Screen Mirroring

If the projected image or sound contains static during Screen Mirroring, try the following solutions:

- Avoid covering the Wi-Fi antenna of the mobile device.
- If you use a Screen Mirroring connection and an internet connection at the same time, the image may stop or contain noise. Disconnect the internet connection to expand your wireless bandwidth and improve the connection speed of the mobile device.
- Make sure the projection contents meet the Screen Mirroring requirements.
- Depending on the settings of the mobile device, the connection may be lost when the device enters power saving mode. Check the electrical power saving settings on the mobile device.
- Update to the latest version of the wireless driver or firmware on the mobile device.

Parent topic: [Solving Network Problems](#)

Related tasks

[Switching to Content Playback Mode](#)

[Projecting a Playlist in Content Playback Mode](#)
[Creating a Playlist Using Epson Web Control](#)
[Adding Effects to the Projected Image](#)

Solutions to Problems Using Content Playback

If you cannot play back a playlist correctly, try the following solutions:

- Check the following on all projectors:
 - All projectors are the same model. If any of the projectors are a different model or have a different resolution, synchronized playback may not be performed properly.
 - Make sure the name, date, and time settings are correct.
 - Make sure all projectors are connected to the same network.
 - Make sure the **Content Playback** setting is turned on in the Operation menu.
- Make sure your USB device contains a playlist.
- Make sure your USB device is connected directly to the projector and not through a USB hub or card reader.
- If the USB device is partitioned, you may not be able to play back playlists. Delete all of the partitions before saving the playlists on your USB device.
- Do not share a playlist between projectors that are different in resolution. Color and shape effects added by using the **Overlay Effect** setting may not be reproduced correctly.

Parent topic: [Solving Problems](#)

Solutions to HDMI Link Problems

If you cannot control an HDMI device using the HDMI Link feature, try the following solutions:

- Make sure all necessary cables are securely connected and the power is on for the projector and connected video sources.
- Make sure the cables meet the HDMI CEC standard.
- Make sure the connected device meets the HDMI CEC standard. See the documentation supplied with the device for more information.
- Check if the device is available in the **Device Connections** list in the Signal I/O menu. If the device does not appear, it does not meet the HDMI CEC standards. Connect a different device.
- Make sure the connected devices are turned on and in standby status. See the documentation supplied with the device for more information.

- If you connected a new device or changed any connections, make sure the CEC function is set for the connected device. You may need to restart the device.
- Connect no more than three devices that support HDMI CEC at the same time.
- If you have connected a speaker or receiver, set the output to PCM.
- Make sure the HDMI Out Setting is set to **Pass Through** in the Multi-Projection menu (PowerLite EB-L530U/EB-L630U/EB-L630SU/EB-L635SU/EB-L730U/EB-L735U).

Parent topic: [Solving Problems](#)

Related references

[Multiple Projector Operation Settings - Multi-Projection Menu](#)

Where to Get Help (U.S. and Canada)

If you need to contact Epson for technical support services, use the following support options.

Internet Support

Visit Epson's support website at epson.com/support (U.S.) or epson.ca/support (Canada) and select your product for solutions to common problems with your projector. You can download utilities and documentation, get FAQs and troubleshooting advice, or e-mail Epson with your questions.

Speak to a Support Representative

To use the Epson PrivateLine Support service, call (800) 637-7661. This service is available for the duration of your warranty period. You may also speak with a projector support specialist by dialing (562) 276-4394 (U.S.) or (905) 709-3839 (Canada).

Support hours are Monday through Friday, 7 AM to 4 PM, Pacific Time.

Days and hours of support are subject to change without notice. Toll or long distance charges may apply.

Before you call, have the following information ready:

- Product name
- Product serial number (located on the bottom or rear of the projector, or in the menu system)
- Proof of purchase (such as a store receipt) and date of purchase
- Computer or video configuration
- Description of the problem

Purchase Supplies and Accessories

You can purchase screens, other optional accessories, and replacement parts from an Epson authorized reseller. To find the nearest reseller, call 800-GO-EPSON (800-463-7766) in the U.S. or 800-807-7766 in Canada. Or you can purchase online at epsonstore.com (U.S. sales) or epsonstore.ca (Canadian sales).

You can purchase a replacement remote control from an Epson parts distributor [here](#) (U.S. sales) or [here](#) (Canadian sales).

Parent topic: [Solving Problems](#)

Where to Get Help (Latin America)

If you need to contact Epson for technical support services, use the following support options.

Internet Support

Visit Epson's support website at latin.epson.com/support and select your product for solutions to common problems with your projector. You can download utilities and documentation, get FAQs and troubleshooting advice, or e-mail Epson with your questions.

Speak to a Support Representative

Before you call for support, please have the following information ready:

- Product name
- Product serial number (located on the bottom or rear of the projector, or in menu system)
- Proof of purchase (such as a store receipt) and date of purchase
- Computer or video configuration
- Description of the problem

Then call:

Country	Telephone
Argentina	(54 11) 5167-0300 0800-288-37766
Bolivia*	800-100-116
Brazil	State capitals and metropolitan areas: 3004-6627 Other areas: 0800-377-6627 / 0800-EPSONBR
Chile	(56 2) 2484-3400

Country	Telephone
Colombia	Bogota: (57 1) 592-2200 Other cities: 018000-915235
Costa Rica	800-377-6627
Dominican Republic*	1-888-760-0068
Ecuador*	1-800-000-044
El Salvador*	800-6570
Guatemala*	1-800-835-0358
Mexico	Mexico City: (52 55) 1323-2052 Other cities: 01-800-087-1080
Nicaragua*	00-1-800-226-0368
Panama*	00-800-052-1376
Paraguay	009-800-521-0019
Peru	Lima: (51 1) 418-0210 Other cities: 0800-10126
Uruguay	00040-5210067
Venezuela	(58 212) 240-1111

*Contact your local phone company to call this toll-free number from a mobile phone.

Note: Toll or long distance charges may apply. If your country does not appear on the list, contact the sales office in the nearest country.

Purchase Supplies and Accessories

You can purchase optional accessories and replacement parts from an Epson authorized reseller. To find the nearest reseller, go to latin.epson.com. Or you can contact your nearest sales office as described in "Where to Get Help."

Parent topic: [Solving Problems](#)

Technical Specifications

These sections list the technical specifications of your projector.

[General Projector Specifications](#)

[Projector Light Source Specifications](#)

[Remote Control Specifications](#)

[Projector Dimension Specifications](#)

[Projector Electrical Specifications](#)

[Projector Environmental Specifications](#)

[Projector Safety and Approvals Specifications](#)

[Supported Video Display Formats](#)

General Projector Specifications

Type of display	Poly-silicon TFT active matrix
Resolution	1920 × 1200 pixels (WUXGA)
Lens	PowerLite EB-L520U/EB-L530U/EB-L730U/EB-L735U: F=1.5 to 1.7 Focal length: 20 to 31.8 mm PowerLite EB-L630SU/EB-L635SU: F=1.7 Focal length: 11.76 mm
Color reproduction	Up to 1.07 billion colors
Brightness	PowerLite EB-L730U/EB-L735U: Normal (High) power consumption mode: White light output 7000 lumens (ISO 21118 standard) Color light output 7000 lumens Extended power consumption mode: White light output 4900 lumens (ISO 21118 standard)

PowerLite EB-L630SU/EB-L635SU:

Normal (High) power consumption mode:

White light output 6000 lumens (ISO 21118 standard)

Color light output 6000 lumens

Quiet/Extended power consumption mode:

White light output 4200 lumens (ISO 21118 standard)

PowerLite EB-L630U:

Normal (High) power consumption mode:

White light output 6200 lumens (ISO 21118 standard)

Color light output 6200 lumens

Quiet/Extended power consumption mode:

White light output 4340 lumens (ISO 21118 standard)

PowerLite EB-L530U/EB-L520U:

Normal (High) power consumption mode:

White light output 5200 lumens (ISO 21118 standard)

Color light output 5200 lumens

Quiet/Extended power consumption mode:

White light output 3640 lumens (ISO 21118 standard)

Note: Color brightness (color light output) and white brightness (white light output) will vary depending on usage conditions. Color light output measured in accordance with IDMS 15.4; white light output measured in accordance with ISO 21118.

Over 2,500,000:1 with Dynamic Contrast on

Contrast ratio

Image size

(in native aspect ratio)

PowerLite EB-L520U/EB-L530U/EB-L730U/EB-L735U:

50 inches (1.27 m) to 500 inches (12.7 m)

PowerLite EB-L630SU/EB-L635SU:

50 inches (1.27 m) to 200 inches (5.08 m)

Projection distance (in native aspect ratio)	PowerLite EB-L520U/EB-L530U/EB-L730U/EB-L735U: 56.7 inches (1.44 m) to 581.1 inches (14.76 m) (Zoom: Wide) 92.5 inches (2.35 m) to 938.6 inches (23.84 m) (Zoom: Tele) PowerLite EB-L630SU/EB-L635SU: 33.5 inches (0.85 m) to 137.4 inches (3.49 m)
Projection methods	360°
Optical aspect ratio (width-to-height)	16:10
Focus adjustment	Manual
Zoom adjustment (Tele-to-Wide)	PowerLite EB-L520U/EB-L530U/EB-L730U/EB-L735U: 1.0 to 1.6 (Optical Zoom) PowerLite EB-L630SU/EB-L635SU: 1.0 to 1.35 (Digital Zoom)
Internal sound system	10 W monaural
Noise level	PowerLite EB-L730U/EB-L735U/EB-L630SU/EB-L635SU/EB-L630U: 38 dB (Normal power consumption mode) 27 dB (Quiet power consumption mode) PowerLite EB-L530U/EB-L520U: 31 dB (Normal power consumption mode) 23 dB (Quiet power consumption mode)
Keystone correction angle	Vertical: ± 30° Horizontal: ± 30°
USB Type B port compatibility	USB 2.0 compliant port for USB mouse, keyboard, firmware update, or service
USB Type A port compatibility	One USB 1.1 and 2.0 compliant port for USB device input or Epson document camera display

Parent topic: [Technical Specifications](#)

Projector Light Source Specifications

Type	Laser diode
Light source output power	PowerLite EB-L730U/EB-L735U/EB-L630SU/EB-L635SU/EB-L630U: Up to 115.5 W PowerLite EB-L530U/EB-L520U: Up to 44 W x 2
Wavelength	449 to 461 nm
Light source life (approximate)	Normal/Quiet Light Source Mode: Up to about 20000 hours Extended Light Source Mode: Up to about 30000 hours

Note: Turn off this product when not in use to prolong the life of the projector. Laser life will vary depending upon mode selected, environmental conditions, and usage. Brightness decreases over time.

Parent topic: [Technical Specifications](#)

Remote Control Specifications

Reception range	26 feet (8 m)
Batteries	Two alkaline or manganese AA

Parent topic: [Technical Specifications](#)

Projector Dimension Specifications

Height (excluding feet)	4.8 inches (122 mm)
Width	17.3 inches (440 mm)
Depth	12.0 inches (304 mm)

Weight (approximate)	PowerLite EB-L735U/EB-L730U/EB-L635SU/EB-L630SU/EB-L630U: 18.5 lb (8.4 kg)
	PowerLite EB-L530U: 18.1 lb (8.2 kg)
	PowerLite EB-L520U: 17.0 lb (7.7 kg)

Parent topic: [Technical Specifications](#)

Projector Electrical Specifications

Rated frequency	50/60 Hz
Power supply	PowerLite EB-L730U/EB-L735U/EB-L630SU/EB-L635SU/EB-L630U: 100 to 240 V AC \pm 10% 3.6 to 1.6 A
	PowerLite EB-L530U/EB-L520U: 100 to 240 V AC \pm 10% 3.1 to 1.4 A
Power consumption (100 to 120 V)	Operating: PowerLite EB-L730U/EB-L735U/EB-L630SU/EB-L635SU/EB-L630U: Normal power consumption mode: 358 W Quiet/Extended power consumption mode: 267 W
	PowerLite EB-L530U/EB-L520U: Normal power consumption mode: 301 W Quiet/Extended power consumption mode: 232 W
	Standby: 0.3 W (Communication Off), 2.0 W (Communication On)

Power consumption

(220 to 240 V)

Operating:

PowerLite EB-L730U/EB-L735U/EB-L630SU/EB-L635SU/EB-L630U:

Normal power consumption mode: 345 W

Quiet/Extended power consumption mode: 258 W

PowerLite EB-L530U/EB-L520U:

Normal power consumption mode: 293 W

Quiet/Extended power consumption mode: 223 W

Standby:

0.3 W (Communication Off), 2.0 W (Communication On)

Parent topic: [Technical Specifications](#)

Projector Environmental Specifications

Temperature

Single projector (up to 7500 feet [2286 m]):

Operating: 32 to 113 °F (0 to 45 °C)

Single projector (over 7500 feet [2286 m]):

Operating: 32 to 104 °F (0 to 40 °C)

Multiple projectors (up to 7500 feet [2286 m]):

Operating: 32 to 104 °F (0 to 40 °C)

Multiple projectors (over 7500 feet [2286 m]):

Operating: 32 to 95 °F (0 to 35 °C)

Storage: 14 to 140 °F (-10 to 60 °C)

Light source brightness automatically dims if the surrounding temperature gets too high — approximately 95 °F (35 °C) at an altitude of 0 to 7,500 feet (2,286 m), and approximately 86 °F (30 °C) at an altitude above 7,500 feet (2,286 m). This may vary depending on the surrounding environment.

Humidity (relative, non-condensing)

Operating: 20 to 80%

Storage: 10 to 90%

Operating altitude Up to 4921 feet (1500 m)
Up to 10,000 feet (3048 m) with High Altitude Mode enabled

Parent topic: [Technical Specifications](#)

Projector Safety and Approvals Specifications

United States FCC Part 15 Class B (DoC)
UL60950-1 2nd edition
UL62368-1 2nd edition
(cTUVus Mark)

Canada ICES-003 Class B
CSA C22.2 No.60950-1-07
CSA C22.2 No.62368-1-14
(cTUVus Mark)

Parent topic: [Technical Specifications](#)

Supported Video Display Formats

For best results, your computer's monitor port or video card resolution should be set to display in the projector's native resolution. However, your projector includes Epson's SizeWise chip that supports other computer display resolutions, so your image will be resized to fit automatically.

Your computer's monitor port or video card refresh rate (vertical frequency) must be compatible with the projector. (See your computer or video card manual for details.)

The table here lists the compatible refresh rate and resolution for each compatible video display format.

Display format	Refresh rate (in Hz)	Resolution (in pixels)
Computer signals (analog RGB)		
VGA	60/72/75/85	640 × 480
SVGA	60/72/75/85	800 × 600
XGA	60/70/75/85	1024 × 768

Display format	Refresh rate (in Hz)	Resolution (in pixels)
WXGA	60-1	1280 × 768
	60-3	1366 × 768
	60/75/85	1280 × 800
WXGA+	60/75/85	1440 × 900
WXGA++	60	1600 × 900
SXGA1	70/75/85	1152 × 864
SXGA2	60/75/85	1280 × 960
SXGA3	60/75/85	1280 × 1024
SXGA+	60/75	1400 × 1050
WSXGA+	60	1680 × 1050
UXGA	60	1600 × 1200
1920 × 1080	50/60	1920 × 1080
WUXGA (Reduced Blanking)	60	1920 × 1200
Component video		
SDTV (480p)	59.94	720 × 480
SDTV (576p)	50	720 × 576
HDTV (720p)	50/59.94/60	1280 × 720
HDTV (1080p)	50/59.94/60	1920 × 1080
HDMI/HDBaseT Control input signals		
VGA	60	640 × 480
SVGA	60	800 × 600
XGA	60	1024 × 768
WXGA	60	1280 × 800
	60-3	1366 × 768
WXGA+	60	1440 × 900
WXGA++	60	1600 × 900

Display format	Refresh rate (in Hz)	Resolution (in pixels)
WSXGA+	60	1680 × 1050
SXGA2	60	1280 × 960
SXGA3	60	1280 × 1024
SXGA+	60	1400 × 1050
UXGA	60	1600 × 1200
1920 × 1080	50/60	1920 × 1080
WUXGA (Reduced Blanking)	60	1920 × 1200
QXGA	60	2048 × 1536
WQHD	60	2560 × 1440
WQXGA (Reduced Blanking)	60	2560 × 1600
SDTV (480i/480p)	59.94	720 × 480
SDTV (576i/576p)	50	720 × 576
HDTV (720p)	50/59.94/60	1280 × 720
HDTV (1080i)	50/59.94/60	1920 × 1080
HDTV (1080p)	23.98/24/29.97/30/50/59.94/60	1920 × 1080
4K	23.98/24/25/29.97/30/50/59.94/60	3840 × 2160
4K (SMPTE)	23.98/24/50/59.94/60	4096 × 2160
Unique Aspect		
Unique Aspect (16:6)	60	1920 × 720

Parent topic: [Technical Specifications](#)

Notices

Check these sections for important notices about your projector.

[Recycling \(U.S. and Canada\)](#)

[Important Safety Information](#)

[Laser Safety Information](#)

[Important Safety Instructions](#)

[List of Safety Symbols \(corresponding to IEC60950-1 A2\)](#)

[FCC Compliance Statement](#)

[Binding Arbitration and Class Waiver](#)

[Trademarks](#)

[Copyright Notice](#)

Recycling (U.S. and Canada)

Epson offers a recycling program for end of life products. Please go to [this site](#) for information on how to return your products for proper disposal.

Parent topic: [Notices](#)

Important Safety Information

Warning: Never look into the projector lens when the laser is on. This can damage your eyes and is especially dangerous for children and pets. Before cleaning any part of the projector, turn it off and unplug the power cord. Never open any cover on the projector, except as specifically explained in this manual. Dangerous electrical voltages in the projector can injure you severely.

Warning: The projector and its accessories come packaged in plastic bags. Keep plastic bags away from small children to avoid any risk of suffocation.

Parent topic: [Notices](#)

Laser Safety Information

This projector is a Class 1 laser product that complies with the IEC/EN60825-1:2014 international standard for lasers. Follow these safety instructions when using the projector.

Warning: Possibly hazardous optical radiation emitted from this product. Do not look at operating light source. Eye injury may result.

- If an error occurs in the projector, turn off the power and unplug the projector immediately. Continuing to use the projector could result in an electric shock, fire, or visual impairment. Contact Epson support.
- Do not attempt to disassemble or modify the projector. The projector contains a high-power laser component. Serious injury could result.
- Do not look into the lens during projection. Also, do not look into the lens using optical devices, such as a magnifying glass or telescope. This could cause visual impairment.
- Do not place flammable objects in front of the lens. Objects could catch fire.
- When turning on the projector at a distance using the remote control, make sure no one is looking into the lens.
- Do not allow small children to operate the projector. Children must be accompanied by an adult.
- Do not apply optical devices, such as a magnifying glass or reflector, to the projected image. Using the projector may result in physical harm, fire, or an accident.
- Do not block the light from the lens during projection. The high temperature in this area could cause burns, fire, or other damage. The lens may overheat due to the reflected light and could cause the projector to malfunction.
- Before using the projector, make sure there is nothing in the area that could reflect the projected image.
- When disposing of the projector, do not disassemble it. Dispose of the projector in accordance with your local or national laws and regulations.

Laser warning labels are attached to the projector.

- **Inside**



- **Top**

As with any bright source, do not stare into the beam (RG2 IEC/EN 62471-5:2015).

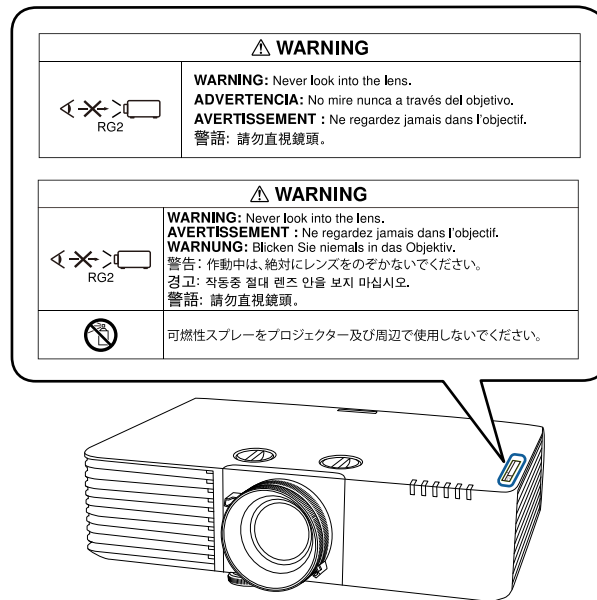

Warning: MOUNT ABOVE THE HEADS OF CHILDREN. The use of a ceiling mount is recommended with this product to place it above the eyes of children.

Complies with FDA performance standards for laser products except for conformance as a Risk Group 2 LIP as defined in IEC 62471-5: Ed. 1.0. For more information see Laser Notice No. 57, dated May 8, 2019.

Parent topic: [Notices](#)

Important Safety Instructions

Follow these safety instructions when setting up and using the projector:

- Do not look into the lens when the projector is on. The bright light can damage your eyes. Avoid standing in front of the projector so the bright light does not shine into your eyes.
- When turning on the projector at a distance using the remote control, make sure there is no one looking into the lens.

- Do not place the projector on an unstable cart, stand, or table or on a surface that is unable to support its weight. Otherwise, it could fall or topple causing an accident and injury.
- You must install a ceiling mount when suspending the projector from a ceiling. If you do not install the projector correctly, it could fall and cause damage or injury.
- Failure to install the ceiling mount and projector may cause the projector to fall. After installing the specific Epson mount that supports your projector, make sure you secure the mount to all of the projector's ceiling mount fixing points. Also, secure the projector and the mounts using wire that is strong enough to hold their weight.
- Do not install in locations where salt damage could occur, or in locations subject to corrosive gas such as sulphuric gas from hot springs. Otherwise, corrosion could cause the projector to fall. It could also cause the projector to malfunction.
- When installing the projector in a high position, take measures to prevent it from falling by using wires to ensure safety in an emergency, such as an earthquake, and to prevent accidents. If the projector is not installed correctly, the projector could fall. This may result in injury or accidents. Contact your dealer to carry out the installation work.
- When installing or adjusting a ceiling or wall mount, do not use adhesives to prevent the screws from loosening and do not use oils or lubricants. This may cause the projector case to crack and the projector to fall from its ceiling mount. This could cause serious injury to anyone under the mount and could damage the projector.
- Do not install the projector in locations exposed to high humidity and dust, such as on a kitchen counter, in the kitchen, or near a humidifier, or in locations exposed to oil smoke or steam. Doing so could cause fire or electric shock. The projector's case could also deteriorate and be damaged causing the projector to fall from the mount.

Examples of environments that could cause the projector to fall due to case deterioration:

- Locations subject to excessive smoke or airborne oil particles, such as factories or kitchens
- Locations containing volatile solvents or chemicals, such as factories or laboratories
- Locations where the projector could be subjected to detergents or chemicals, such as factories or kitchens
- Locations in which aroma oils are often used, such as relaxation rooms
- Near devices that produce excessive smoke, airborne oil particles, or foam at events
- Do not use the projector near water, sources of heat, high-voltage electrical wires, or sources of magnetic fields.
- Use the type of power source indicated on the projector. Use of a different power source may result in fire or electric shock. If you are not sure of the power available, consult your dealer or power company.

- Place the projector near a wall outlet where the plug can be easily unplugged.
- Take the following precautions when handling the plug: Do not hold the plug with wet hands. Do not insert the plug into a dusty outlet. Insert the plug firmly into the outlet. Do not pull the power cord when disconnecting the plug; always be sure to hold the plug when disconnecting it. Do not overload wall outlets, extension cords, or power strips. Failure to comply with these precautions could result in fire or electric shock.
- Do not place the projector where the cord can be walked on. This may result in fraying or damage to the plug.
- Unplug the projector from the wall outlet and allow to cool before cleaning. Use a dry cloth (or, for stubborn dirt or stains, a moist cloth that has been wrung dry) for cleaning. Do not use liquid or aerosol cleaners, any sprays containing flammable gas, or solvents such as alcohol, paint thinner, or benzene.
- Do not block the slots and openings in the projector case. They provide ventilation and prevent the projector from overheating. If the vents are covered, the internal temperature could rise and cause a fire. Do not place the projector in locations subject to high temperatures, such as near heating equipment. Do not operate the projector on a sofa, rug, or other soft surface, or set it on top of loose papers. Do not cover the projector with a blanket, curtain, or tablecloth. If you are setting up the projector near a wall, leave at least 7.9 inches (20 cm) of space between the wall and the projector. On the side where hot air is exhausted from the projector, leave at least 16 inches (40 cm) of space between the wall and the projector.
- Do not operate the projector in a closed-in cabinet unless proper ventilation is provided.
- Never allow objects of any kind to enter any openings in the projector. Do not leave objects, especially flammable objects, near the projector. Never spill liquid of any kind into the projector.
- If you are using two or more projectors side-by-side, leave at least 59 inches (150 cm) of space between the projectors to allow for proper ventilation.
- You may need to clean the air filter and vent. A clogged air filter or vent can block ventilation needed to cool the projector. Do not use canned air, or the gases may leave a residue.
- Do not use or store the projector in locations where it will be subject to dust or dirt. Otherwise, the quality of the projected image may decline, or the air filter may become clogged, resulting in a malfunction or fire.
- Do not store the projector outdoors for an extended length of time.
- Except as specifically explained in this manual, do not attempt to service this product yourself. Refer all servicing to qualified personnel. Opening or removing covers may expose you to dangerous voltages and other hazards.
- Never open any covers on the projector except as specifically explained in this manual. Never attempt to disassemble or modify the projector. Refer all repairs to qualified service personnel.

- Unplug the projector from the wall outlet and refer servicing to qualified service personnel under the following conditions: if it does not operate normally when you follow the operating instructions, or exhibits a distinct change in performance; if smoke, strange odors, or strange noises come from the projector; if the power cord or plug is damaged or frayed; if liquid or foreign objects get inside the projector, or if it has been exposed to rain or water; if it has been dropped or the housing has been damaged.
- Do not touch the plug during an electrical storm. Otherwise, you may receive an electric shock.
- Unplug the projector when it will not be used for extended periods.
- Do not use the projector where it may be exposed to rain, water, or excessive humidity.
- Do not use or store the projector where it may be exposed to smoke, steam, corrosive gases, excessive dust, vibration, or shock.
- Do not use the projector where flammable or explosive gases may be present.
- Do not use or store the projector or remote control in a hot location, such as near a heater, in direct sunlight, or in a closed vehicle.
- If you use the projector in a country other than where you purchased it, use the correct power cord for that country.
- Do not stand on the projector or place heavy objects on it.
- Do not use the projector outside of the required temperature range below (20 to 80% humidity, no condensation):
32 to 113 °F (0 to 45 °C) at an altitude of 7500 feet (2286 m) or less, or 32 to 104 °F (0 to 40 °C) at an altitude of 7500 to 10000 feet (2286 to 3048 m)
When using multiple projectors at the same time:
32 to 104 °F (0 to 40 °C) at an altitude of 7500 feet (2286 m) or less, or 32 to 95 °F (0 to 35 °C) at an altitude of 7500 to 10000 feet (2286 m to 3048 m)
Doing so may cause an unstable display and could lead to projector damage. Do not use or store the projector where it may be exposed to sudden changes in temperature.
- Do not store the projector outside of the required temperature range of 14 to 140 °F (–10 to 60 °C) or in direct sunlight for long periods of time. Doing so may cause damage to the case.
- Do not place anything that can become warped or damaged by heat near the exhaust vents. Do not bring your hands or face close to the vents while projection is in progress. Do not bring your face close to the projector while it is in use.
- Before you move the projector, make sure its power is turned off, the plug is disconnected from the outlet, and all cables are disconnected.

- Do not place the source of an open flame, such as a lit candle, on or near the projector.
- Do not modify the power cord. Do not place heavy objects on top of the power cord or bend, twist, or pull it excessively. Keep the power cord away from hot electrical appliances.

[Restriction of Use](#)

Parent topic: [Notices](#)

Restriction of Use



When this product is used for applications requiring high reliability/safety such as transportation devices related to aviation, rail, marine, automotive; disaster prevention devices; various safety devices; or functional/precision devices, you should use this product only after giving consideration to including fail-safes and redundancies into your design to maintain safety and total system reliability.







Because this product was not intended for use in applications requiring extremely high reliability/safety such as aerospace equipment, main communication equipment, nuclear power control equipment, or medical equipment related to direct medical care, please make your own judgment on this product's suitability after a full evaluation.







Parent topic: [Important Safety Instructions](#)









List of Safety Symbols (corresponding to IEC60950-1 A2)





The following table lists the meaning of the safety symbols labeled on the equipment.

No.	Symbol	Approved Standards	Description
1		IEC60417 No.5007	"ON" (power) To indicate connection to the mains.
2		IEC60417 No.5008	"OFF" (power) To indicate disconnection from the mains.
3		IEC60417 No.5009	Stand-by To identify the switch or switch position by means of which part of the equipment is switched on in order to bring it into the stand-by condition.

No.	Symbol	Approved Standards	Description
4		ISO7000 No.0434B, IEC3864-B3.1	Caution To identify general caution when using the product.
5		IEC60417 No.5041	Caution, hot surface To indicate that the marked item can be hot and should not be touched without taking care.
6		IEC60417 No.6042 ISO3864-B3.6	Caution, risk of electric shock To identify equipment that has risk of electric shock.
7		IEC60417 No.5957	For indoor use only To identify electrical equipment designed primarily for indoor use.
8		IEC60417 No.5926	Polarity of DC power connector To identify the positive and negative connections (the polarity) on a piece of equipment to which a DC power supply may be connected.
9		—	Polarity of DC power connector To identify the positive and negative connections (the polarity) on a piece of equipment to which a DC. power supply may be connected.
10		IEC60417 No.5001B	Battery, general On battery powered equipment. To identify a device for instance a cover for the battery compartment, or the connector terminals.

No.	Symbol	Approved Standards	Description
11		IEC60417 No.5002	Positioning of cell To identify the battery holder itself and to identify the positioning of the cell(s) inside the battery holder.
12		—	Positioning of cell To identify the battery holder itself and to identify the positioning of the cell(s) inside the battery holder.
13		IEC60417 No.5019	Protective earth To identify any terminal which is intended for connection to an external conductor for protection against electric shock in case of a fault, or the terminal of a protective earth electrode.
14		IEC60417 No.5017	Earth To identify an earth (ground) terminal in cases where neither the symbol No.13 is explicitly required.
15		IEC60417 No.5032	Alternating current To indicate on the rating plate that the equipment is suitable for alternating current only; to identify relevant terminals.
16		IEC60417 No.5031	Direct current To indicate on the rating plate that the equipment is suitable for direct current only; to identify relevant terminals.
17		IEC60417 No.5172	Class II equipment To identify equipment meeting the safety requirements specified for Class II equipment according to IEC 61140.

No.	Symbol	Approved Standards	Description
18		ISO 3864	General prohibition To identify actions or operations that are prohibited.
19		ISO 3864	Contact prohibition To indicate injury that could occur due to touching a specific part of the equipment.
20		—	Never look into the optical lens while the projector is on.
21		—	To indicate that the marked item don't place anything on projector.
22		ISO3864 IEC60825-1	Caution, laser radiation To indicate the equipment has a laser radiation part.
23		ISO 3864	Disassembly prohibition To indicate a risk of injury, such as electric shock, if the equipment is disassembled.
24		IEC60417 No. 5266	Standby, partial standby To indicate that part of the equipment is in the ready status.
25		ISO3864 IEC60417 No. 5057	Caution, movable parts To indicate that you must keep away from movable parts according to protection standards.

No.	Symbol	Approved Standards	Description
27		IEC 60417-6056	Caution (movable fan blades) To indicate that you must keep away from the blades of the movable fan according to protection standards.
28		IEC 60417-6043	Caution (sharp corners) To indicate that you must not touch the sharp corners of the product according to protection standards.
29		—	Never look into the projection lens while the projector is on.
30		ISO7010 No. W027	Warning, light emission (UV, visible light, IR and so on) To indicate that you must be careful not to injure your eyes or skin when near light emitting sections.
31		IEC60417 No. 5109	Not to be used in residential areas To indicate that the electrical equipment/device is not suitable for use in residential area.

Parent topic: [Notices](#)

FCC Compliance Statement

For United States Users

This equipment has been tested and found to comply with the limits for a Class B digital device, pursuant to Part 15 of the FCC Rules. These limits are designed to provide reasonable protection against harmful interference in a residential installation. This equipment generates, uses, and can radiate radio frequency energy and, if not installed and used in accordance with the instructions, may cause harmful interference to radio communications. However, there is no guarantee that interference will not occur in a particular installation. If this equipment does cause interference to radio and television reception, which

can be determined by turning the equipment off and on, the user is encouraged to try to correct the interference by one or more of the following measures:

- Reorient or relocate the receiving antenna.
- Increase the separation between the equipment and receiver.
- Connect the equipment into an outlet on a circuit different from that to which the receiver is connected.
- Consult the dealer or an experienced radio/TV technician for help.

This device complies with part 15 of the FCC Rules. Operation is subject to the following two conditions: (1) This device may not cause harmful interference, and (2) this device must accept any interference received, including interference that may cause undesired operation.

WARNING

The connection of a non-shielded equipment interface cable to this equipment will invalidate the FCC Certification or Declaration of this device and may cause interference levels which exceed the limits established by the FCC for this equipment. It is the responsibility of the user to obtain and use a shielded equipment interface cable with this device. If this equipment has more than one interface connector, do not leave cables connected to unused interfaces. Changes or modifications not expressly approved by the manufacturer could void the user's authority to operate the equipment.

For Canadian Users

CAN ICES-3(B)/NMB-3(B)

Parent topic: [Notices](#)

Binding Arbitration and Class Waiver

1. DISPUTES, BINDING INDIVIDUAL ARBITRATION, AND WAIVER OF CLASS ACTIONS AND CLASS ARBITRATIONS

1.1 Disputes. The terms of this Section 1 shall apply to all Disputes between you and Epson. The term "Dispute" is meant to have the broadest meaning permissible under law and includes any dispute, claim, controversy or action between you and Epson arising out of or relating to this Agreement, Epson branded products (hardware and including any related software), or other transaction involving you and Epson, whether in contract, warranty, misrepresentation, fraud, tort, intentional tort, statute, regulation, ordinance, or any other legal or equitable basis. "DISPUTE" DOES NOT INCLUDE IP CLAIMS, or more specifically, a claim or cause of action for (a) trademark infringement or dilution, (b) patent infringement, (c) copyright infringement or misuse, or (d) trade secret misappropriation (an "IP Claim"). You and Epson also agree, notwithstanding Section 1.6, that a court, not an arbitrator, may decide if a claim or cause of action is for an IP Claim.

1.2 Binding Arbitration. You and Epson agree that all Disputes shall be resolved by binding arbitration according to this Agreement. **ARBITRATION MEANS THAT YOU WAIVE YOUR RIGHT TO A JUDGE OR JURY IN A COURT PROCEEDING AND YOUR GROUNDS FOR APPEAL ARE LIMITED.**

Pursuant to this Agreement, binding arbitration shall be administered by JAMS, a nationally recognized arbitration authority, pursuant to its code of procedures then in effect for consumer related disputes, but excluding any rules that permit joinder or class actions in arbitration (for more detail on procedure, see Section 1.6 below). You and Epson understand and agree that (a) the Federal Arbitration Act (9 U.S.C. §1, et seq.) governs the interpretation and enforcement of this Section 1, (b) this Agreement memorializes a transaction in interstate commerce, and (c) this Section 1 shall survive termination of this Agreement.

1.3 Pre-Arbitration Steps and Notice. Before submitting a claim for arbitration, you and Epson agree to try, for sixty (60) days, to resolve any Dispute informally. If Epson and you do not reach an agreement to resolve the Dispute within the sixty (60) days, you or Epson may commence an arbitration. Notice to Epson must be addressed to: Epson America, Inc., ATTN: Legal Department, 3131 Katella Ave., Los Alamitos, CA 90720 (the "Epson Address"). The Dispute Notice to you will be sent to the most recent address Epson has in its records for you. For this reason, it is important to notify us if your address changes by emailing us at EAlegal@ea.epson.com or writing us at the Epson Address above. Notice of the Dispute shall include the sender's name, address and contact information, the facts giving rise to the Dispute, and the relief requested (the "Dispute Notice"). Following receipt of the Dispute Notice, Epson and you agree to act in good faith to resolve the Dispute before commencing arbitration.

1.4 Small Claims Court. Notwithstanding the foregoing, you may bring an individual action in the small claims court of your state or municipality if the action is within that court's jurisdiction and is pending only in that court.

1.5 WAIVER OF CLASS ACTIONS AND CLASS ARBITRATIONS. YOU AND EPSON AGREE THAT EACH PARTY MAY BRING DISPUTES AGAINST THE OTHER PARTY ONLY IN AN INDIVIDUAL CAPACITY, AND NOT AS A PLAINTIFF OR CLASS MEMBER IN ANY CLASS OR REPRESENTATIVE PROCEEDING, INCLUDING WITHOUT LIMITATION FEDERAL OR STATE CLASS ACTIONS, OR CLASS ARBITRATIONS. CLASS ACTION LAWSUITS, CLASS-WIDE ARBITRATIONS, PRIVATE ATTORNEY-GENERAL ACTIONS, AND ANY OTHER PROCEEDING WHERE SOMEONE ACTS IN A REPRESENTATIVE CAPACITY ARE NOT ALLOWED. ACCORDINGLY, UNDER THE ARBITRATION PROCEDURES OUTLINED IN THIS SECTION, AN ARBITRATOR SHALL NOT COMBINE OR CONSOLIDATE MORE THAN ONE PARTY'S CLAIMS WITHOUT THE WRITTEN CONSENT OF ALL AFFECTED PARTIES TO AN ARBITRATION PROCEEDING.

1.6 Arbitration Procedure. If you or Epson commences arbitration, the arbitration shall be governed by the rules of JAMS that are in effect when the arbitration is filed, excluding any rules that permit arbitration on a class or representative basis (the "JAMS Rules"), available at <http://www.jamsadr.com> or by calling 1-800-352-5267 (U.S. or Canada), or <https://www.jamsadr.com/about/> or by calling +1-949-224-1810 (Latin America), and under the rules set forth in this Agreement. All Disputes shall be resolved by a

single neutral arbitrator, and both parties shall have a reasonable opportunity to participate in the selection of the arbitrator. The arbitrator is bound by the terms of this Agreement. The arbitrator, and not any federal, state or local court or agency, shall have exclusive authority to resolve all disputes arising out of or relating to the interpretation, applicability, enforceability or formation of this Agreement, including any claim that all or any part of this Agreement is void or voidable. Notwithstanding this broad delegation of authority to the arbitrator, a court may determine the limited question of whether a claim or cause of action is for an IP Claim, which is excluded from the definition of "Disputes" in Section 1.1 above. The arbitrator shall be empowered to grant whatever relief would be available in a court under law or in equity. The arbitrator may award you the same damages as a court could, and may award declaratory or injunctive relief only in favor of the individual party seeking relief and only to the extent necessary to provide relief warranted by that party's individual claim. In some instances, the costs of arbitration can exceed the costs of litigation and the right to discovery may be more limited in arbitration than in court. The arbitrator's award is binding and may be entered as a judgment in any court of competent jurisdiction.

You may choose to engage in arbitration hearings by telephone. Arbitration hearings not conducted by telephone shall take place in a location reasonably accessible from your primary residence, or in Orange County, California, at your option.

a) Initiation of Arbitration Proceeding. If either you or Epson decides to arbitrate a Dispute, both parties agree to the following procedure:

(i) Write a Demand for Arbitration. The demand must include a description of the Dispute and the amount of damages sought to be recovered. You can find a copy of a Demand for Arbitration at <http://www.jamsadr.com> ("Demand for Arbitration").

(ii) Send three copies of the Demand for Arbitration, plus the appropriate filing fee, to: JAMS, 500 North State College Blvd., Suite 600 Orange, CA 92868, U.S.A.

(iii) Send one copy of the Demand for Arbitration to the other party (same address as the Dispute Notice), or as otherwise agreed by the parties.

b) Hearing Format. During the arbitration, the amount of any settlement offer made shall not be disclosed to the arbitrator until after the arbitrator determines the amount, if any, to which you or Epson is entitled. The discovery or exchange of non-privileged information relevant to the Dispute may be allowed during the arbitration.

c) Arbitration Fees. Epson shall pay, or (if applicable) reimburse you for, all JAMS filings and arbitrator fees for any arbitration commenced (by you or Epson) pursuant to provisions of this Agreement.

d) Award in Your Favor. For Disputes in which you or Epson seeks \$75,000 or less in damages exclusive of attorney's fees and costs, if the arbitrator's decision results in an award to you in an amount greater than Epson's last written offer, if any, to settle the Dispute, Epson will: (i) pay you \$1,000 or the amount of the award, whichever is greater; (ii) pay you twice the amount of your reasonable attorney's fees, if any; and (iii) reimburse you for any expenses (including expert witness fees and costs) that your attorney

reasonably accrues for investigating, preparing, and pursuing the Dispute in arbitration. Except as agreed upon by you and Epson in writing, the arbitrator shall determine the amount of fees, costs, and expenses to be paid by Epson pursuant to this Section 1.6d).

e) Attorney's Fees. Epson will not seek its attorney's fees and expenses for any arbitration commenced involving a Dispute under this Agreement. Your right to attorney's fees and expenses under Section 1.6d) above does not limit your rights to attorney's fees and expenses under applicable law; notwithstanding the foregoing, the arbitrator may not award duplicative awards of attorney's fees and expenses.

1.7 Opt-out. You may elect to opt-out (exclude yourself) from the final, binding, individual arbitration procedure and waiver of class and representative proceedings specified in this Agreement by sending a written letter to the Epson Address within thirty (30) days of your assent to this Agreement (including without limitation the purchase, download, installation of the Software or other applicable use of Epson Hardware, products and services) that specifies (i) your name, (ii) your mailing address, and (iii) your request to be excluded from the final, binding individual arbitration procedure and waiver of class and representative proceedings specified in this Section 1. In the event that you opt-out consistent with the procedure set forth above, all other terms shall continue to apply, including the requirement to provide notice prior to litigation.

1.8 Amendments to Section 1. Notwithstanding any provision in this Agreement to the contrary, you and Epson agree that if Epson makes any future amendments to the dispute resolution procedure and class action waiver provisions (other than a change to Epson's address) in this Agreement, Epson will obtain your affirmative assent to the applicable amendment. If you do not affirmatively assent to the applicable amendment, you are agreeing that you will arbitrate any Dispute between the parties in accordance with the language of this Section 1 (or resolve disputes as provided for in Section 1.7, if you timely elected to opt-out when you first assented to this Agreement).

1.9 Severability. If any provision in this Section 1 is found to be unenforceable, that provision shall be severed with the remainder of this Agreement remaining in full force and effect. **The foregoing shall not apply to the prohibition against class or representative actions as provided in Section 1.5. This means that if Section 1.5 is found to be unenforceable, the entire Section 1 (but only Section 1) shall be null and void.**

Parent topic: [Notices](#)

Trademarks

EPSON®, PowerLite® and Quick Corner® are registered trademarks, EPSON Exceed Your Vision is a registered logomark, and Epson iProjection is a trademark of Seiko Epson Corporation.

PrivateLine® is a registered trademark and SizeWise™ is a trademark of Epson America, Inc.

Windows is a registered trademark of Microsoft Corporation in the United States and/or other countries.

Mac, macOS, and OS X are trademarks of Apple Inc., registered in the U.S. and other countries.

App Store is a service mark of Apple Inc.

Google® is a registered trademark and Android™, Google Chrome™, Chromebook™, Android TV™, and Google Play™ are trademarks of Google LLC.

Miracast® is a registered trademark and Wi-Fi®, WPA2®, and WPA3® are trademarks of Wi-Fi Alliance®.

HDMI, the HDMI Logo and High-Definition Multimedia Interface are trademarks or registered trademarks of HDMI Licensing Administrator, Inc.

"QR Code" is a registered trademark of DENSO WAVE INCORPORATED.

Crestron® and Crestron Connected® are registered trademarks of Crestron Electronics, Inc.

Extron® and XTP® are registered trademarks of RGB Systems Incorporated.

HDBaseT™ and the HDBaseT Alliance logo are trademarks of the HDBaseT Alliance.

The PLink trademark is a trademark applied for registration or is already registered in Japan, the United States of America and other countries and areas.

General Notice: Other product names used herein are for identification purposes only and may be trademarks of their respective owners. Epson disclaims any and all rights in those marks.



Parent topic: [Notices](#)

Copyright Notice

All rights reserved. No part of this publication may be reproduced, stored in a retrieval system, or transmitted in any form or by any means, electronic, mechanical, photocopying, recording, or otherwise, without the prior written permission of Seiko Epson Corporation. The information contained herein is designed only for use with this Epson product. Epson is not responsible for any use of this information as applied to other products.

Neither Seiko Epson Corporation nor its affiliates shall be liable to the purchaser of this product or third parties for damages, losses, costs, or expenses incurred by purchaser or third parties as a result of: accident, misuse, or abuse of this product or unauthorized modifications, repairs, or alterations to this product, or (excluding the U.S.) failure to strictly comply with Seiko Epson Corporation's operating and maintenance instructions.

Seiko Epson Corporation shall not be liable for any damages or problems arising from the use of any options or any consumable products other than those designated as Original Epson Products or Epson Approved Products by Seiko Epson Corporation.

This information is subject to change without notice.

[A Note Concerning Responsible Use of Copyrighted Materials](#)

[Copyright Attribution](#)

Parent topic: [Notices](#)

A Note Concerning Responsible Use of Copyrighted Materials

Epson encourages each user to be responsible and respectful of the copyright laws when using any Epson product. While some countries' laws permit limited copying or reuse of copyrighted material in certain circumstances, those circumstances may not be as broad as some people assume. Contact your legal advisor for any questions regarding copyright law.

Parent topic: [Copyright Notice](#)

Copyright Attribution

© 2021 Epson America, Inc.

12/21

CPD-61218R2

Parent topic: [Copyright Notice](#)