

# NEXO

powered by  YAMAHA

---

## **NXAMP4X1 & NXAMP4X4 Powered TDcontrollers**

 *User Manual v1.7 (LOAD2\_52)*



## FCC INFORMATION (U.S.A.)

### 1. IMPORTANT NOTICE: DO NOT MODIFY THIS UNIT!

This product, when installed as indicated in the instructions contained in this manual, meets FCC requirements. Modifications not expressly approved by NEXO-SA may void your authority, granted by the FCC, to use the product.

### 2. IMPORTANT:

When connecting this product to accessories and/or another product use only high quality shielded cables. Cable/s supplied with this product MUST be used. Follow all installation instructions. Failure to follow instructions could void your FCC authorization to use this product in the USA.

### 3. NOTE:

This product has been tested and found to comply with the requirements listed in FCC Regulations, Part 15 for Class "B" digital devices. Compliance with these requirements provides a reasonable level of assurance that your use of this product in a residential environment will not result in harmful interference with other electronic devices. This equipment generates/uses radio frequencies and, if not installed and used according to the instructions found in the users manual, may cause interference harmful to the operation of other electronic devices.

Compliance with FCC regulations does not guarantee that interference will not occur in all installations. If this product is found to be the source of interference, which can be determined by turning the unit "OFF" and "ON", please try to eliminate the problem by using one of the following measures:

Relocate either this product or the device that is being affected by the interference.





Utilize power outlets that are on different branch (circuit breaker or fuse) circuits or install AC line filter/s.

In the case of radio or TV interference, relocate/reorient the antenna. If the antenna lead-in is 300 ohm ribbon lead, change the lead-in to co-axial type cable.

If these corrective measures do not produce satisfactory results, please contact the local retailer authorized to distribute this type of product. If you can not locate the appropriate retailer, please contact the After Sales department of NEXO-SA, Parc d'Activité du Pré de la Dame Jeanne, B.P. 5, 60128 PLAILLY

The above statements apply ONLY to those products distributed by NEXO-SA or its subsidiaries.

\* This applies only to products distributed in the United States of America.

 <p>The lightning flash with arrowhead symbol, within an equilateral triangle is intended to alert the user to the presence of uninsulated "dangerous voltage" within the product's enclosure that may be of sufficient magnitude to constitute a risk of electric shock to persons.</p>	 <p><b>CAUTION</b> RISK OF ELECTRIC SHOCK DO NOT OPEN</p> 	 <p>The exclamation point within an equilateral triangle is intended to alert the user to the presence of important operating and maintenance (servicing) instructions in the literature accompanying the appliance.</p>
<p><b>WARNING: To reduce the risk of fire or electric shock, do not expose this apparatus to rain or moisture.</b></p>		
<p><b>To avoid electrical shock, do not remove covers. Dangerous voltages exist inside. Refer all servicing to qualified personnel only.</b></p>		

The above warning is located on the top of the unit.

## IMPORTANT SAFETY INSTRUCTIONS

- 1 Read these instructions.
- 2 Keep these instructions.
- 3 Heed all warnings.
- 4 Follow all instructions.
- 5 Do not use this apparatus near water.
- 6 Clean only with dry cloth.
- 7 Do not block any ventilation openings. Install in accordance with the manufacturer's instructions.
- 8 Do not install near any heat sources such as radiators, heat registers, stoves, or other apparatus (including amplifiers) that produce heat.
- 9 Do not defeat the safety purpose of the polarized or grounding-type plug. A polarized plug has two blades with one wider than the other. A grounding type plug has two blades and a third grounding prong. The wide blade or the third prong are provided for your safety. If the

- provided plug does not fit into your outlet, consult an electrician for replacement of the obsolete outlet.
- 10 Protect the power cord from being walked on or pinched particularly at plugs, convenience receptacles, and the point where they exit from the apparatus.
- 11 Only use attachments/accessories specified by the manufacturer.
- 12 Unplug this apparatus during lightning storms or when unused for long periods of time.
- 13 Refer all servicing to qualified service personnel. Servicing is required when the apparatus has been damaged in any way, such as power-supply cord or plug is damaged, liquid has been spilled or objects have fallen into the apparatus, the apparatus has been exposed to rain or moisture, does not operate normally, or has been dropped.

## PRECAUTIONS

Please read carefully before proceeding. Please keep this manual in a safe place for future reference.

 <p><b>WARNING</b></p> <p>Always follow the basic precautions listed below to avoid the possibility of serious injury or even death from electrical shock, short-circuiting, damages, fire or other hazards. These precautions include, but are not limited to, the following:</p>
---

## Power supply/Power cord

- Only use the voltage specified as correct for the device. The required voltage is printed on the name plate of the device.
- Use only the included power cord.
- Do not place the power cord near heat sources such as heaters or radiators, and do not excessively bend or otherwise damage the cord, place heavy objects on it, or place it in a position where anyone could walk on, trip over, or roll anything over it.
- Be sure to connect to an appropriate outlet with a protective grounding connection. Improper grounding can result in electrical shock.

## Do not open

- Do not open the device or attempt to disassemble the internal parts or modify them in any way. The device contains no user-serviceable parts. If it should appear to be malfunctioning, discontinue use immediately and have it inspected by qualified NEXO-SA service personnel.



## CAUTION

**Always follow the basic precautions listed below to avoid the possibility of physical injury to you or others, or damage to the device or other property. These precautions include, but are not limited to, the following:**

## Power supply/Power cord

- Remove the electric plug from the outlet when the device is not to be used for extended periods of time, or during electrical storms.
- When removing the electric plug from the device or an outlet, always hold the plug itself and not the cord. Pulling by the cord can damage it.
- If you are using the NXAMP4X4, be sure to plug each power cord into separate branch circuits employing separate service grounds. Plugging into the same circuit can result in electrical shock.
- To disconnect the NXAMP4X4 from the mains, unplug both power cords.

## Location

- When transporting or moving the device, always use two or more people. Attempting to lift the device by yourself may damage your back, result in other injury, or cause damage to the device itself.
- Before moving the device, remove all connected cables.
- When setting up the device, make sure that the AC outlet you are using is easily accessible. If some trouble or malfunction occurs, immediately turn off the power switch and disconnect the plug from the outlet. Even when the power switch is turned off, electricity is still flowing to the product at the minimum level. When you are not using the product for a long time, make sure to unplug the power cord from the wall AC outlet.
- If this device is to be mounted in an EIA-standard rack, leave the back of the rack open and make sure that it is at least 10 cm away from walls or surfaces. Also, if this device is to be mounted with devices that tend to generate heat, such as power amplifiers, be sure to keep an adequate gap between this device and the heat-generating devices or install ventilation panels to prevent high temperatures from developing inside this device.

Inadequate ventilation can result in overheating, possibly causing damage to the device(s), or even fire.

- Do not use the device in a confined, poorly-ventilated location. If this device is to be used in a small space other than an EIA-standard rack, make sure that there is adequate space between the device and surrounding walls or other devices: at least 10 cm at the sides, 15 cm behind and 40 cm above. Inadequate ventilation can result in overheating, possibly causing damage to the device(s), or even fire.
- Do not expose the device to excessive dust or vibrations, or extreme cold or heat (such as in direct sunlight, near a heater, or in a car during the day) to prevent the

## Water warning

- Do not expose the device to rain, use it near water or in damp or wet conditions, or place containers on it containing liquids which might spill into any openings.

If any liquid such as water seeps into the device, turn off the power immediately and unplug the power cord from the AC outlet. Then have the device inspected by qualified NEXO-SA service personnel.

- Never insert or remove an electric plug with wet hands.

## If you notice any abnormality

- If the power cord or plug becomes frayed or damaged, or if there is a sudden loss of sound during use of the device, or if any unusual smells or smoke should appear to be caused by it, immediately turn off the power switch, disconnect the electric plug from the outlet, and have the device inspected by qualified NEXO-SA service personnel.
- If this device should be dropped or damaged, immediately turn off the power switch, disconnect the electric plug from the outlet, and have the device inspected by qualified NEXO-SA service personnel.

possibility of panel disfiguration or damage to the internal components.

- Do not place the device in an unstable position where it might accidentally fall over.
- Do not block the vents. This device has ventilation holes at the front/rear to prevent the internal temperature from becoming too high. In particular, do not place the device on its side or upside down. Inadequate ventilation can result in overheating, possibly causing damage to the device(s), or even fire.
- Do not use the device in the vicinity of a TV, radio, stereo equipment, mobile phone, or other electric devices. Doing so may result in noise, both in the device itself and in the TV or radio next to it.

## Connections

- Before connecting the device to other devices, turn off the power for all devices. Before turning the power on or off for all devices, set all volume levels to minimum.
- Use only speaker cables for connecting speakers to the speaker jacks. Use of other types of cables may result in fire.

## Maintenance

- Inspect the cooling fans and clean them periodically. Dust and dirt can seriously degrade the effectiveness of the cooling fan and result in malfunction or fire.
- Remove the power plug from the AC outlet when cleaning the device.

## Handling caution

- When turning on the AC power in your audio system, always turn on the device LAST, to avoid speaker damage. When turning the power off, the device should be turned off FIRST for the same reason.
- Do not insert your fingers or hands in any gaps or openings on the device (vents...)
- Avoid inserting or dropping foreign objects (paper, plastic, metal, etc.) into any gaps or openings on the device (vents, etc.) If this happens, turn off the power immediately and unplug the power cord from the AC outlet. Then have the device inspected by qualified NEXO-SA service personnel.
- Do not use the device for a long period of time at a high or uncomfortable volume level, since this can cause permanent hearing loss. If you experience any hearing loss or ringing in the ears, consult a physician.
- Do not rest your weight on the device or place heavy objects on it, and avoid use excessive force on the buttons, switches or connectors.
- Do not use this device for any purpose other than driving loudspeakers.

**XLR-type connectors are wired as follows (IEC60268 standard): pin 1: ground, pin 2: hot (+), and pin 3: cold (-).  
Use only Neutrik NL4 plugs for connecting Speakon connectors.**

**NEXO-SA cannot be held responsible for damage caused by improper use or modifications to the device or data that is lost or destroyed.**

- Always turn the power off when the device is not in use.
- The performance of components with moving contacts, such as switches, volume controls, and connectors, deteriorates over time. Consult qualified NEXO-SA service personnel about replacing defective components.
- If you do not intend to rack-mount the NXAMP, attach the included rubber feet to the bottom surface of the device.

## IMPORTANT NOTICE FOR THE UNITED KINGDOM

### Connecting the Plug and Cord

**WARNING: THIS APPARATUS MUST BE EARTHED**

IMPORTANT. The wires in this mains lead are colored in accordance with the following code:

GREEN-AND-YELLOW: EARTH

BLUE : NEUTRAL

BROWN : LIVE

As the colors of the wires in the mains lead of this apparatus may not correspond with the colored markings identifying the terminals in your plug proceed as follows:

The wire which is colored GREEN-and-YELLOW must be connected to the terminal in the plug which is marked by the letter E or by the safety earth symbol  or colored GREEN or GREEN-and-YELLOW.

The wire which is colored BLUE must be connected to the terminal which is marked with the letter N or colored BLACK.

The wire which is colored BROWN must be connected to the terminal which is marked with the letter L or colored RED.

- This applies only to products distributed in the United Kingdom.

## COMPLIANCE INFORMATION STATEMENT (DECLARATION OF CONFORMITY PROCEDURE)

1) This device may not cause harmful interference, and

2) This device must accept any interference received including interference that may cause undesired operation. See user manual instructions if interference to radio reception is suspected.

\* This applies only to products distributed in the United States of America.

## EUROPEAN MODELS

Purchaser/User Information specified in EN55103-1 and EN55103-2.

Inrush Current: 16 A

Conforms to Environments: E1, E2, E3 and E4.

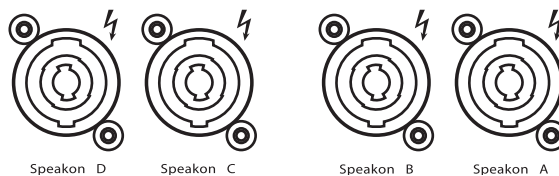

This  mark indicates a dangerous electrically live terminal. When connecting an external wire to this terminal, it is necessary either to have "a person who have received appropriate guidance on handling" make the connection or to use leads or a cord that have been manufactured in such way that the connection can be made simply and without problem.

**TABLE OF CONTENT**

**FCC INFORMATION (U.S.A.).....3**

**IMPORTANT SAFETY INSTRUCTIONS.....3**

**PRECAUTIONS.....3**

POWER SUPPLY/POWER CORD .....4

DO NOT OPEN .....4

WATER WARNING.....4

IF YOU NOTICE ANY ABNORMALITY.....4

**POWER SUPPLY/POWER CORD .....4**

**LOCATION.....4**

**CONNECTIONS .....4**

**MAINTENANCE.....4**

**HANDLING CAUTION.....4**

**IMPORTANT NOTICE FOR THE UNITED KINGDOM.....6**

**COMPLIANCE INFORMATION STATEMENT (DECLARATION OF CONFORMITY PROCEDURE).....6**

**EUROPEAN MODELS .....6**

**TABLE OF CONTENT .....6**

**NXAMP VERSUS NX242: WHAT’S NEW? ..... 11**

**WHAT’S REMAINING THE SAME? ..... 11**

DSP CORE ..... 11

LEVEL AND LATENCY ..... 11

SOFTWARE ..... 11

**WHAT’S CHANGED?..... 11**

INTEGRATED AMPLIFIER ..... 11

COMPUTING RESOURCES ..... 12

FOUR SEPARATE INPUTS ..... 12

POWER SUPPLY..... 12

ETHERSOUND™ OPTIONAL BOARD..... 12

USER INTERFACE..... 12

**QUICK START.....13**

**FRONT PANEL DESCRIPTION..... 13**

TABLE OF CONTENT

(1) POWER SWITCH .....	13
(2) AMPLIFIER INDICATORS .....	13
(3) LCD DISPLAY .....	14
(4) ENCODER .....	14
(5) NAVIGATION BUTTONS (A & B).....	14
(6) VOLUME INDICATORS .....	14
(7) MUTE BUTTONS .....	14
(8) SELECT BUTTONS.....	14
(9) CHANNEL INDICATORS.....	15
(10) AIR INTAKES .....	15
(11) SCREW HOLES FOR HANDLES.....	15
<b>BACK PANELS DESCRIPTION .....</b>	<b>16</b>
(1) MAINS CONNECTORS.....	16
(2) BALANCED AUDIO INPUTS WITH LINK.....	16
(3) EXPANSION SLOT .....	17
(4) POWER OUTPUTS .....	17
(5) RS-232 PORT .....	17
(6) GPIO PORT .....	17
(7) REAR END MOUNTING HOLES .....	18
<b>BASIC FUNCTIONS .....</b>	<b>18</b>
RESET.....	18
SELECTING CABINET FAMILY .....	18
SELECT YOUR CABINET SET-UP.....	18
USING THE AMPLIFIER WITHOUT THE TDCONTROLLER FUNCTIONALITY.....	19
BACK TO DEFAULT .....	19
AUTO SAVE.....	19
ENTER THE DOWNLOAD MODE.....	19
<b><u>WHAT'S INSIDE THE CARTON BOX.....</u></b>	<b><u>20</u></b>
<b><u>SETTING-UP ADVICE.....</u></b>	<b><u>21</u></b>
EARTH CONNECTION.....	21
MAINS SETTING.....	21
MOUNTING THE NXAMP IN A RACK (GROUNDING, SHIELDING & SAFETY ISSUES) .....	22
USING THE NXAMP WITHOUT A RACK .....	23
FUSES.....	23
ELECTROMAGNETIC ENVIRONMENTS .....	23
ANALOGUE INPUT SIGNAL CABLES .....	24
NXAMP POWER OUTPUTS WIRING .....	25
<b><u>GENERAL DESCRIPTION.....</u></b>	<b><u>26</u></b>
<b>GLOBAL ARCHITECTURE .....</b>	<b>26</b>
NXAMP4X1 GLOBAL ARCHITECTURE.....	26
NXAMP4X4 GLOBAL ARCHITECTURE.....	26
POWER SUPPLY BLOCK .....	27
ANALOG INPUT BLOCK .....	28
CONTROL BLOCK .....	28
POWER AMPLIFIER BLOCKS.....	29
POWER OUTPUTS BLOCK.....	29
USER INTERFACE BLOCK.....	30
COMMUNICATION BLOCK .....	30
EXPANSION SLOT BLOCK .....	31
<b><u>BLOCK DIAGRAM DESCRIPTION.....</u></b>	<b><u>32</u></b>

TABLE OF CONTENT

<b>PATCHING AND ROUTING (1)</b> .....	<b>33</b>
<b>DELAY &amp; POLARITY INVERSION (2)</b> .....	<b>33</b>
FACTORY SET-UP DELAY .....	33
USER SET-UP DELAY .....	33
<b>EQUALISATION &amp; FILTERING</b> .....	<b>33</b>
SUBSONIC AND VHF FILTERING (3).....	33
EQUALISING WIDEBAND ACOUSTICAL RESPONSE (3) .....	34
USER SET-UP, ARRAY EQ (4).....	34
EQUALISING SINGLE COMPONENT RESPONSE AND NXSTREAM PROCESSING (5) .....	34
CROSSOVER SECTION (6).....	34
POST PROTECTION EQ AND LOW PASS (27) (28).....	34
GAIN SECTION (29).....	34
<b>PROTECTIONS</b> .....	<b>35</b>
SOURCE SIGNALS FOR PROTECTION ALGORITHMS (25) .....	35
DISPLACEMENT CONTROL (7) (8) (9).....	35
MECHANICAL STRESS CONTROL (10) (11).....	35
HF DISPLACEMENT CONTROL (12).....	36
HF ACCELERATION CONTROL (13) .....	36
GLOBAL PURPOSE VCEQ (14) .....	36
LOUDSPEAKER PEAK LIMITERS (15).....	36
TEMPERATURE CONTROL (16) (17) .....	36
INTERCHANNEL REGULATION (19) .....	37
AMPLIFIER PEAK CURRENT LIMITER (20).....	37
AMPLIFIER INTEGRATE CURRENT LIMITER (21) .....	37
AMPLIFIER PEAK VOLTAGE LIMITER (22).....	37
AMPLIFIER SHORT CIRCUIT DETECTOR (24).....	37
<b><u>MENU DESCRIPTION</u></b> .....	<b><u>38</u></b>
<b>CHANGING CABINET FAMILY</b> .....	<b>38</b>
<b>ADJUSTING VOLUME</b> .....	<b>39</b>
<b>ADJUSTING DELAY</b> .....	<b>40</b>
<b>ADJUSTING GAIN</b> .....	<b>41</b>
<b>ADJUSTING ARRAY EQ</b> .....	<b>42</b>
<b>ADJUSTING HEADROOM</b> .....	<b>42</b>
HEADROOM CONCEPT.....	43
<b>OPTIONS MENU</b> .....	<b>44</b>
SYSTEM CONFIG .....	45
INPUT PATCH .....	46
SAVE/RECALL USER SETUPS .....	48
SECURITY.....	50
GPIO MODE.....	52
MISCELLANEOUS OPTIONS .....	56
<b><u>INSTALLATION RECOMMENDATIONS</u></b> .....	<b><u>57</u></b>
<b>AUDIO CHAIN RECOMMENDATIONS</b> .....	<b>57</b>
ABOUT « LOUDSPEAKER MANAGEMENT DEVICES » .....	57
OPERATING SUB'S FED THROUGH AN AUX OUTPUT .....	57
OPERATION OF MULTIPLE POWERED TDCONTROLLERS .....	57
<b>SYSTEM ALIGNMENT</b> .....	<b>57</b>
GEOMETRICAL ALIGNMENT .....	58
MEASURING AND ALIGNING PHASE IN THE OVERLAPPING REGION .....	58
<b><u>NXES104 EXPANSION BOARD AND REMOTE CONTROL</u></b> .....	<b><u>60</u></b>
<b>NXES104 PHYSICAL DESCRIPTION</b> .....	<b>60</b>



TABLE OF CONTENT

(1) ETHERSOUND™ IN PORT .....	60
(2) ETHERSOUND™ NETWORK STATUS LEDS .....	61
(3) ETHERSOUND™ OUT PORT .....	61
(4) REMOTE ES100 PORT .....	61
<b>VARIOUS ETHERSOUND™ DEVICES DESCRIPTION.....</b>	<b>61</b>
MONO-DIRECTIONAL, NON ES100 DEVICES .....	62
BI-DIRECTIONAL, NON ES100 DEVICES .....	62
ES100 DEVICES .....	62
ES100/SPKR DEVICES .....	62
<b>ETHERNET ADDITIONAL HARDWARE .....</b>	<b>63</b>
HUBS .....	63
SWITCHES .....	63
WIRELESS LAN .....	63
ETHERNET CABLES .....	64
FIBER OPTIC .....	66
<b>INSTALLATION INSIDE THE NXAMP .....</b>	<b>66</b>
<b>NXAMP CONTROL PAGE IN ESMONITOR SOFTWARE .....</b>	<b>66</b>
COMPATIBILITY ISSUES .....	67
GRAPHICAL USER INTERFACE .....	67
(1) VIRTUAL FRONT PANEL .....	68
(2) INPUT METERS .....	68
(3) STANDBY BUTTON .....	69
(4) DELAY UNIT .....	69
(5) SECURITY LOCK .....	69
(6) GROUP .....	69
(7) INPUT PATCH .....	70
(8) OUTPUT METERS .....	71
(9) MUTE BUTTON .....	71
(10) VOLUME CONTROL .....	71
(11) GAIN CONTROL .....	71
(12) DELAY SETTINGS .....	71
(13) ARRAYEQ SETTINGS .....	71
(14) HEADROOM SETTINGS .....	71
(15) AMPLIFIER STATUS .....	71
(16) OVERMUTE .....	72
(17) NOTES .....	73
(18) LOCATION .....	73
(19) ALIAS .....	73
(20) HARDWARE AND FIRMWARE .....	73
(21) SCENE .....	73
(22) CABINET SETUP .....	74
(23) VIRTUAL FRONT PANEL SIZE .....	74
<b><u>NXWIN4 SOFTWARE FOR NXAMP FIRMWARE UPGRADE .....</u></b>	<b><u>75</u></b>
<b>WHAT YOU NEED TO UPGRADE YOUR NXAMP .....</b>	<b>75</b>
SERIAL PORT UPGRADE .....	75
ETHERSOUND™ UPGRADE .....	76
<b>CONNECT THE COMPUTER TO THE NXAMP .....</b>	<b>76</b>
(1) REMOTE ES100 PORT .....	76
(2) ETHERSOUND™ IN PORT .....	76
(3) RS-232 SERIAL PORT .....	76
<b>USING THE NXWIN4 SOFTWARE.....</b>	<b>76</b>
PUT THE NXAMP IN DOWNLOAD MODE .....	78
BEGIN THE UPGRADE .....	78
<b>USING THE CONTROLLER AFTER A FIRMWARE UPDATE .....</b>	<b>79</b>
CHOOSING A CABINET SETUP .....	79

TABLE OF CONTENT

SELECTING CABINET FAMILY ..... 79  
SELECT YOUR CABINET SET-UP..... 79

**TECHNICAL SPECIFICATIONS..... 80**

**THERMAL DISSIPATION AND CURRENT DRAWN ..... 81**

**DIMENSIONS..... 82**

**APPLICATION NOTE: DRIVING THE SUB FROM THE AUX SEND..... 83**

WHAT IS THE PHASE RELATION BETWEEN THE AUX AND MAIN OUTPUT OF YOUR DESK? ..... 83  
WHY IT IS UNLIKELY THE AUX AND MAIN HAVE THE SAME PHASE? ..... 83  
CONSEQUENCES OF BADLY ALIGNED SYSTEMS..... 83  
PRECAUTIONS & CHECK ..... 84

**APPENDIX A: LIST OF SUPPORTED PRESETS (LOAD2 52) ..... 86**

**APPENDIX B: HOW IS MEASURED THE AMPLIFIER POWER? ..... 87**

GENERAL DESCRIPTION OF THE SETUP ..... 87  
PRECISION OF THE MEASUREMENT ..... 88  
MEASUREMENT METHOD ..... 88

**USABLE MAINS CORD IN EUROPE..... 89**

**ROHS CERTIFICATE..... 90**

**USER NOTES..... 91**

## **NXAMP versus NX242: What's new?**

The NXAMP Powered TDcontroller has been designed in order to provide ascendant compatibility with its predecessor – the NX242 Digital TDcontroller.

### **What's remaining the same?**

#### **DSP core**

The DSP used in the NXAMP are from the same family (same core) than the one used in NX242 and on the NXTENSION board. Thus algorithms such as EQ will perform exactly the same on both platforms to allow the user to mix NXAMP and NX242 with traditional amplifiers at the same time. However, computing resources are higher on the NXAMP (see further), thus some setup will perform only with this hardware.

#### **Level and latency**

Global delays due to analog to digital and/or digital to analog as well as global gain are identical on NXAMP on one side and NX242 with 26dB gain amplifiers on the other side (of course attenuators should be placed to 0 dB).

Also when used with Ethersound™ networks (through the optional NXES104 board) the NXAMP has the same gain and delay from digital input to analog output than NX242-ES4 with traditional 26dB amplifier.

Please note however that both NX242 and NXAMP should have the same firmware revision (LOAD) to be phase compatible inside a same setup.

#### **Software**

Basic MENUs and functions are more or less the same; only little learning curve is needed to go from the NX242 to the NXAMP.

The same LOAD and NXWIN software are used to update both TDcontrollers and NXAMP Powered TDcontroller firmware. The transition is transparent for the user. Note however, that the NXAMP can't be flashed with LOADs prior to 2\_46, and must use NXWIN 4 software.

### **What's changed?**

#### **Integrated amplifier**

The most notable improvement is the integration of the amplifier module that will simplify the cabling from the user point of view but also allow a much more efficient integration of loudspeaker controller with the amplifier needs. Thus the digital controller becomes also an amplifier controller. This is not simply two units inside the same box, but a powerful use of the DSP resources for both cabinets and amplifier being driven.

## Computing resources

The DSP resources have been multiply by 3.5 between the NX242ES4 and the NXAMP (so it means by 7 between the NX242 and the NXAMP). This will ensure that the NXAMP will have enough DSP resources to deal with many years of algorithm improvements. Other key components like CPU speed, memory quantities and so on have been also upgraded.

## Four separate inputs

The analog input stage now offers 4 separate symmetrical inputs, each on XLR with link (due to the 3U , on NXAMP4X1, or 4U , on NXAMP4X4 height of the unit, there is plenty of space for connectors at the back). All the inputs offer considerable 28 dBu headroom (same than on the NX242). These analog inputs leads to last generation 24 bits converters running at 48 KHz (like on the NX242-ES4).

## Power supply

The NXAMP4X1 Powered TDcontroller uses three separate switch mode power supplies (SMPS) whereas the NXAMP4X4 uses 5. A first small power supply is used for powering the TDcontroller digital board, and to initiate the power amp. The other big power supplies are used for power amplifiers:

- On NXAMP4X1, channels 1 & 2 (on one power supply) and for channel 3 and 4 (on the other one).
- On NXAMP4X4, each channel has its own large power supply.

These large power supplies are precisely tailored to work around a precise Mains voltage, so separate model of NXAMP exists for 100 ~ 120 Volts on one side (these are models NXAMP4X1U and NXAMP4X4U), and for 220 ~ 240 Volts on the other side (these are models NXAMP4X1C and NXAMP4X4C).

## Ethersound™ optional board

The NXAMP is designed to accept the optional NXES104 board witch offers four digital inputs among a bidirectional 2x 64 channels Ethersound™ ES100 network. This optional board uses the new NEXO slot which prevents the necessity to open the top panel of the amplifier for installing the board. NXAMP firmware upgrade can also be performed through this Ethersound™ port.

## User interface

The front panel LCD display is now a comfortable 2 x 40 characters display, for easy access to the parameters for each channel.

## Quick Start

This section will allow you to quickly understand the basic functions of this product. If you already know the previous NEXO digital TDcontrollers, such as NX241 or NX242, you may be able to use the NXAMP Powered TDcontroller quickly as it has been designed with a similar user interface. However please devote some attention to reading the user manual. A better understanding of specific features of the NXAMP Powered TDcontroller will enable you to operate your system to its full potential.

### Front panel description

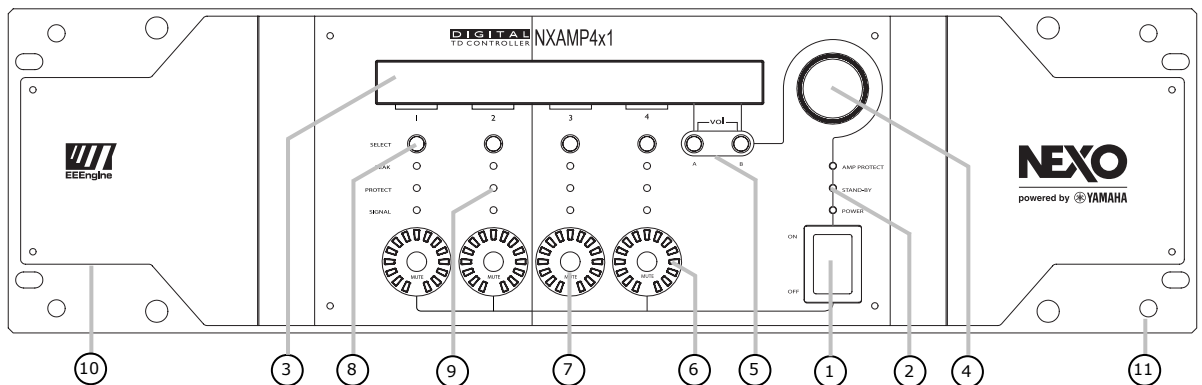

*NB: Front panel of NXAMP4X1 is shown here, but front panel of NXAMP4X4 is similar, except the model name and the global height of the unit.*

#### (1) Power switch

Put the switch in the upper position to turn the power on. Put it down to power the amplifier off. Please note that even in the 'Off' position, high voltage is still present in some part of the amplifier, as long as it is connected to mains. Even if it is in the 'Off' position, the amplifier will consume a minimal current.

If you plan to use remote control to turn the amplifier 'On' or 'Stand-by', then you must first turn this power switch to the 'On' position. No operation is possible when the power switch is on the 'Off' position.

#### (2) Amplifier indicators

These Three LEDs above the power switch indicate the status of the amplifier. The two first LEDs (Power and Stand-by) indicate the power status of the amplifier:

- If both are off, the amplifier is powered off.
- If Power is lit, the amplifier is in use.
- If Stand-by is blinking, the amplifier is in stand-by.

Stand-by mode consumes slightly more current than in Power off mode, but allows the

amplifier to be brought back from Stand-by to power on mode through remote control.

The last LED, 'Amp Protect' reflects the protection status of the amplifier. If this LED is lit, it signifies that the amplifier is reducing or muting one or several outputs due to malfunctions as overheating, output DC, short circuitry ... In combination with other LEDs indicators and LCD display the cause of the problem will be clearly displayed. Please see further for more details. Please also note that the Amp Protect LED will light while the amplifiers power supplies are starting.

### **(3) LCD display**

This large and easily readable 2 x 40 characters display will allow the user to quickly setup the amplifier. Please note that in stand-by mode the backlight of the LCD remains on even if nothing is displayed.

### **(4) Encoder**

The default function of the encoder is to adjust the volume of the amplifier. But depending on the current menu displayed on the LCD, other functions can be affected, such as delay adjustment or speaker setup selection.

### **(5) Navigation buttons (A & B)**

These two buttons are used most of the time to navigate through the menus. However, depending on the LCD display, they can be used for a specific purpose.

Anytime, pressing the two buttons simultaneously will instantly enter the "Volume" menu, allowing the user to adjust the volume for each channel using the encoder.

### **(6) Volume indicators**

These surrounding LEDs will indicate the position of the volume control for each channel, similar to the position given by analog potentiometers on classical amplifiers. If a channel is muted, corresponding Mute button will lit red, but the position of the volume control will blink alternatively for that channel, allowing the user to know what will be the level once the channel is unmuted.

### **(7) Mute buttons**

Whatever the current menu is, pressing the mute button will set or release the mute of the chosen channel. The button will turn to red if the channel is muted.

### **(8) Select buttons**

Use the select buttons to choose the channel on which you want to adjust parameters with the encoder. In most of the menus, the bottom line of the LCD is used to indicate the cabinet name for each channel. If this name is between brackets, it means that the channel is selected. Turning the encoder will then have an effect on this channel.

**(9) Channel indicators**

For each channel, you have three LEDs indicator. The 'Sense' LED will light to green when a certain level of current is detected on the output, meaning that a cabinet is connected and that some signal is flowing to it. The 'Protect' LED will light to yellow if the TDcontroller is applying a VCEQ protection on that channel (see further for details). The 'Peak' LED will light to red to indicate that the peak limiter is working to protect the cabinet or the amplifier.

**(10) Air intakes**

The NXAMP uses forced-air cooling. The variable speed cooling fan draws air in from the front and exhausts it through the rear. Please be sure that you do not block the air intakes or exhaust vents.

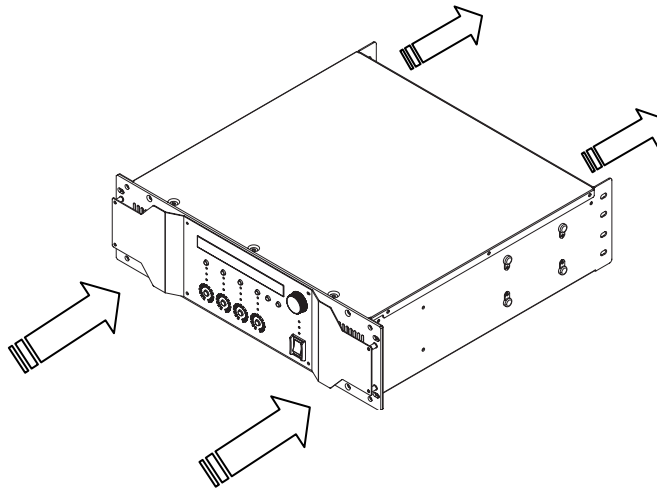

Please be sure not to mix inside the same rack amplifiers with opposite air flow.

**(11) Screw holes for handles**

These four screw holes are for the optional handles. Fix the handles to the amplifier using the flat-head screws included with the handles (Screw driver or key TORX X20 is needed).

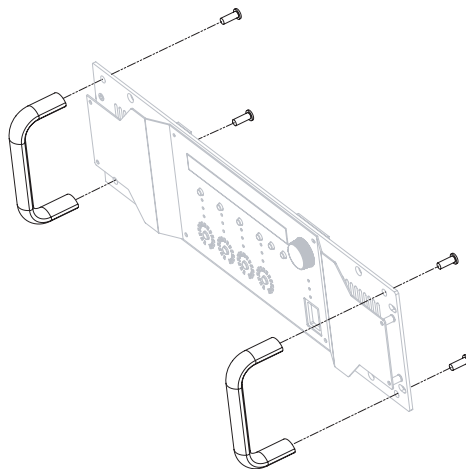

*NB: Separate handle models exist for NXAMP4X1 and NXAMP4X4*

## Back panels description

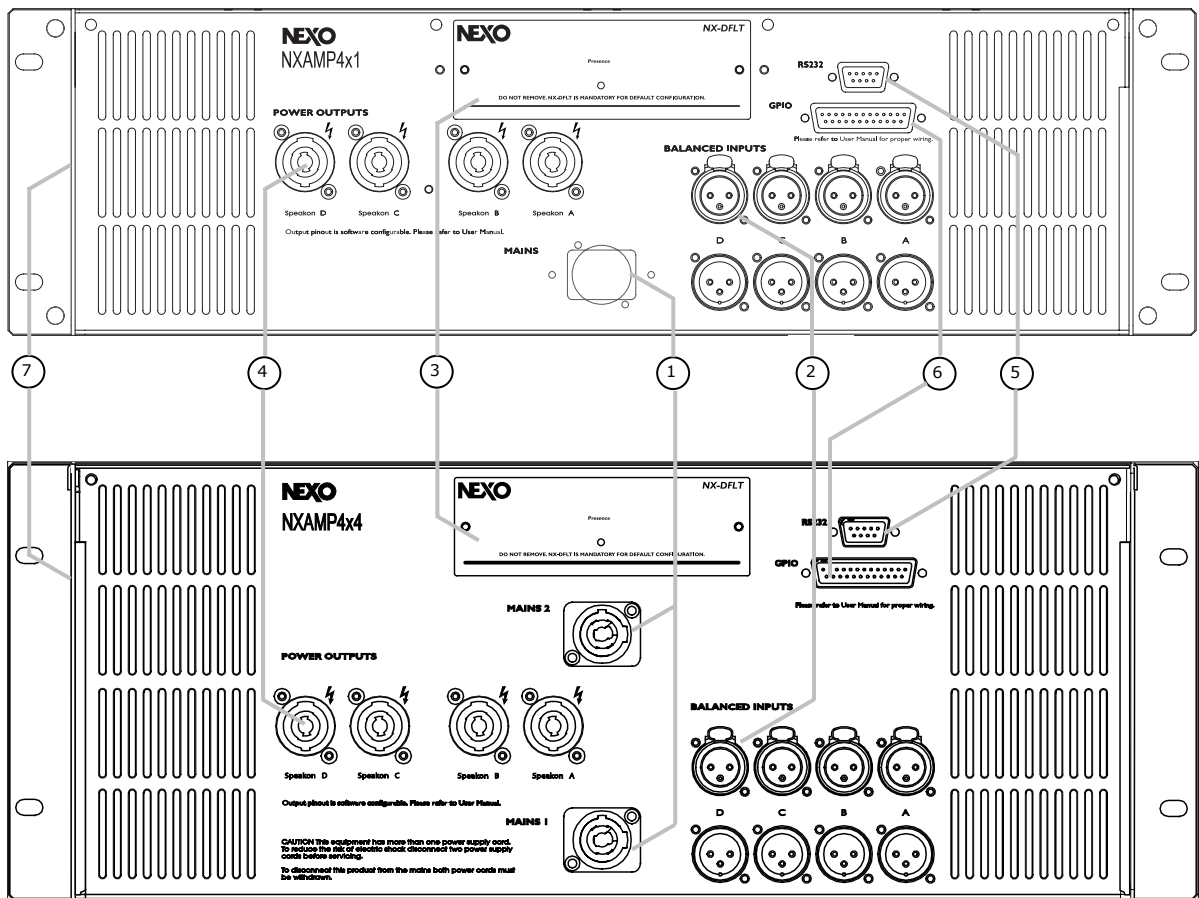

### (1) Mains connectors

This is the mains input for the NXAMP. There is one mains plug on NXAMP4X1 and two mains plug on NXAMP4X4.

- On NXAMP4X1, the plug is a Powercon 20A for the 100 ~ 120 Volts model (ref. NXAMP4X1U) and a standard IEC 3 pin for the 220 Volts model (ref. NXAMP4X1C).
- On NXAMP4X4, the plugs are two Powercon 30A for the 100 ~ 120 Volts model (ref. NXAMP4X4U) and two Powercon 20A for the 220 Volts model (ref. NXAMP4X4C).

The amplifier requires high-power so that it can demand high current from the AC service. Connections must be properly rated for reliable operation. See specification part for details.

### (2) Balanced audio inputs with link

For each of the four analog audio inputs you will find an XLR3 female input connector, and also an XLR3 male connector in parallel for sending back the input signal to another unit.



**(3) Expansion slot**

This slot is used for extra audio inputs and remote control. See further in the manual for details about the available options.

Since July 2009, all NXAMP4x1s and NXAMP4x4s are shipped with an expansion card fitted in, the NX-DFLT card. This card prevents output noises when main AC power feeding NXAMPs is brutally shutdown. NX-DFLT card should always be fitted in when no other expansion card is used. The "Presence" LED on the NX-DFLT card shows that the card is running properly. It will light when the amplifier is powered ON (also in Stand-by mode).

**(4) Power outputs**

Use Neutrik NL4 cable plug into these ports for safely connecting the power amplifier outputs to the cabinets.

**In LOAD2\_52, the output routing is always done this way for 4 channels mode:**

**Please note the symmetry between speakon A/B and C/D. Also you can notice that Speakon B is always reverse of Speakon A (and same for D and C).**

**In LOAD2\_52, the output routing is always done this way in bridge mode:**

*Gray lines shows the points of the speakon physically connected to the amplifier output but unused.*

**(5) RS-232 port**

Through this serial port, you can upload a new firmware into the NXAMP from a computer. New firmware adds new functionalities and new cabinets' setups. Details about the update procedure are given further in this manual.

**(6) GPIO port**

This GPIO port is used for interfacing the amplifier to security system, or to allow a basic remote control of the unit.

**(7) Rear end mounting holes**

If the NXAMP is to be rack mounted and transported frequently, be sure to support the rear end of the unit with mounting hardware that matches the size of the rack used.

**Basic functions**

**Reset**

You can reset the unit without powering off by simultaneously depressing buttons A, B & "Select CH1" for 3 seconds at least.

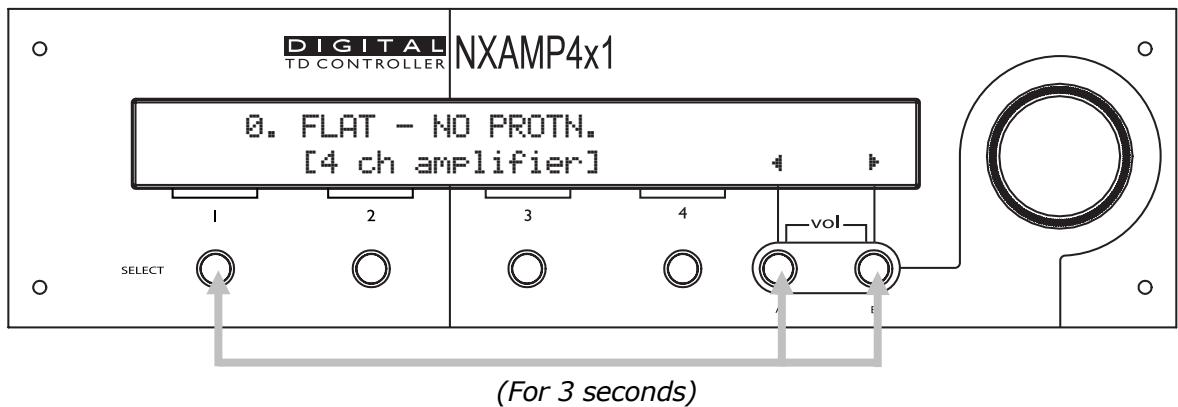

**Selecting cabinet family**

Simultaneously depressing A & B buttons at power up or during device RESET accesses the system change menu. Keep the A & B Buttons held until Load revision disappears from screen (approx. 2 seconds). This will allow the selection of any cabinet in any family. Using the rotary encoder, scroll through the configurations and press "B" to load the required settings.

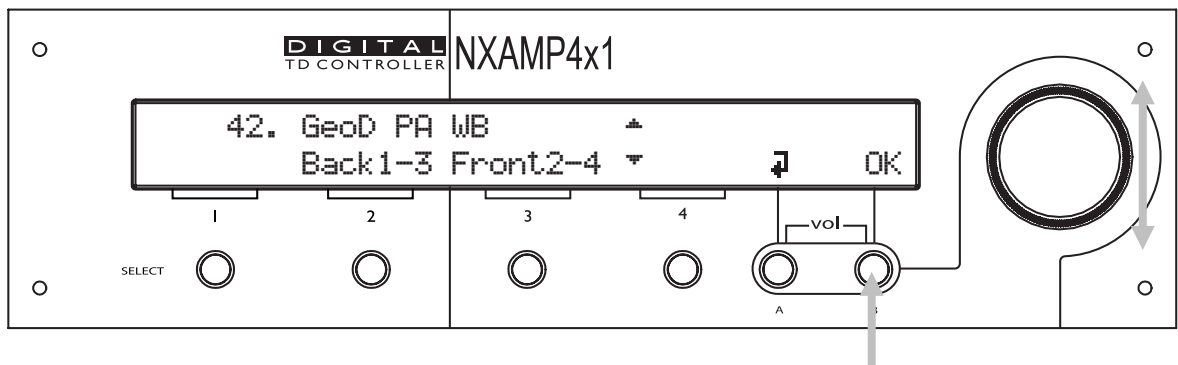

**Select your cabinet set-up**

In the 'Options' menu, choose "System Config", and you will be able to choose among the different set-ups within the same cabinet family. (i.e. you don't have to modify the amplifier to cabinet wiring).

**Using the amplifier without the TDcontroller functionality**

If you want to use the amplifier without the TDcontroller, just choose the "FLAT mode" setup. In this mode, no EQ and no protection is applied to the cabinets. Please note that the amplifier will still have 2.2 ms analog input to analog output latency in that mode (i.e. the same latency than an NX242 TDcontroller in flat mode).

In Flat mode, full amplifier digital protections are still available, and some functionality like volume control, input patching, mute, delay, gain and ArrayEQ are working. Remote control can be used as well.

**Back to default**

Startup the amplifier with the "select 1" button down and you will have the possibility to reset the settings to default (except if the local controls have been locked, see further).

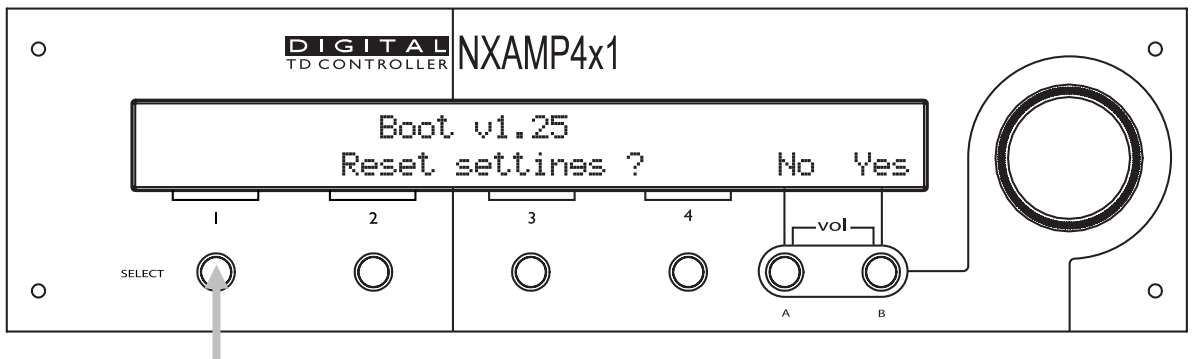

**Auto save**

The current set-up is automatically saved three seconds after the last change of a parameter. At power up the last saved settings are restored.

**Enter the download mode**

Keep the 'mute 1' button down during boot up will enter the download mode. See further for connection to the computer and download software (Nxwin) description.

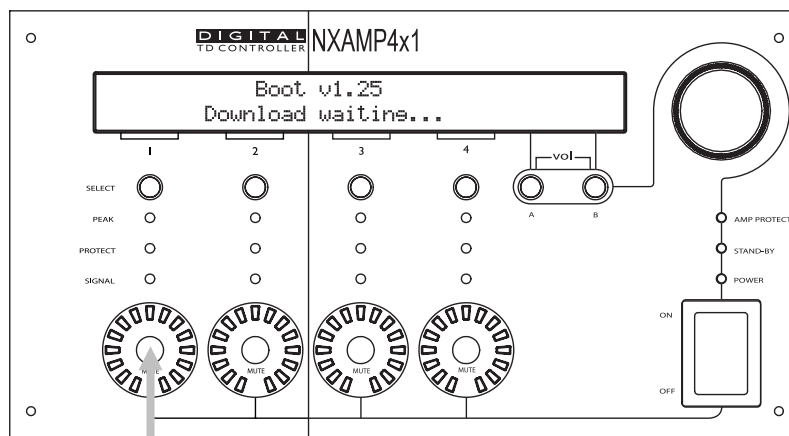

## What's inside the carton box



WARNING ! The shipping weight of the NXAMP4X1 (U or C version) is nearly 21 Kg (46 lb). The shipping weight of the NXAMP4X4 (U or C version) is nearly 30 Kg (66 lb). Because of the large size of the carton box it is recommended to manipulate the box with two persons.

Open the box with care to prevent damage on the content. Inside you will find:

- 1 x NXAMP Quick start guide (32 pages, 7 languages)
- 4 x Rubber pad
- 1 x NXAMP Powered TDcontroller with NX-DFLT card fitted.
- 1 x Mains cord (for NXAMP4X1) or 2 x Mains cord (for NXAMP4X4).

*N.B.: The provided mains cord is Chinese type for NXAMP4X1C or NXAMP4X4C (220 ~ 240 Volts version) and US type for NXAMP4X1U or NXAMP4X4U (100 ~ 120 Volts version).*

## Setting-Up Advice

### Earth connection



WARNING! THIS APPLIANCE MUST BE EARTHED.

The green and yellow wire of the mains cord must always be connected to an installation safety earth or ground. The earth is essential for personal safety as well as the correct installation of the system, and is internally connected to all exposed metal surfaces. Any rack framework into which this unit may be mounted is assumed to be connected to the same grounding circuit.

### Mains setting

NEXO NXAMP Powered TDcontrollers exists under two references for each model:

NXAMP Reference	Mains Voltage	Mains current
<b>NXAMP4X1U</b>	100 to 120 Volts	Max 20 Amps
<b>NXAMP4X1C</b>	220 to 240 Volts	Max 10 Amps
<b>NXAMP4X4U</b>	100 to 120 Volts	Max 2x 30 Amps
<b>NXAMP4X4C</b>	220 to 240 Volts	Max 2x 16 Amps

Each model applies to various safety standards only when use with the correct mains voltage. Therefore, the amplifier won't start (or will stop working) if the mains voltage is getting out of the following min and max limits:

NXAMP Reference	Mains Minimum Voltage	Mains Maximum Voltage
<b>NXAMP4X1U or NXAMP4X4U</b>	60 Volts	150 Volts
<b>NXAMP4X1C or NXAMP4X4C</b>	150 Volts	288 Volts

*N.B.: The maximum amplifier output voltage is proportional to the mains voltage.*

**Mounting the NXAMP in a rack (Grounding, shielding & safety issues)**

The NXAMP Powered TDcontroller is intended for rack mounting. The only accessible part during use shall be the front panel of the unit. Any space above or under the TDcontroller shall be obstructed with a blank panel.

The rack is a free grounding and shielding structure and it provides extra shielding. Therefore, it is desirable that the screws used to fix the NXAMP Powered TDcontroller in the frame or rack provides an electrical contact between the chassis of the TDcontroller and the rack.

The primary reason for grounding is safety. Conformance to the applicable requirements of the authorities having jurisdiction is, of course, mandatory. However, grounding also has an impact on electromagnetic compatibility. From the EMC point of view, it is desirable to have a low impedance ground network, as a current flowing in the ground network will then produce low voltage in the network. A low impedance network can be obtained using a multipoint ground scheme, with as many closed ground loops as is economically possible.

Because of the amplifier weight, it is mandatory to fix the amplifier both from the front panel and from the rear ears. The picture bellow shows the dimensions between the rack holes on the front panel.

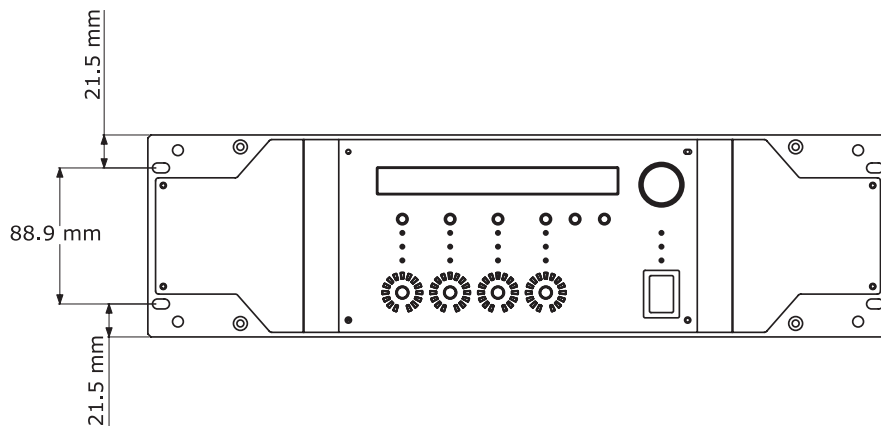

*NXAMP4X1 rack holes position*

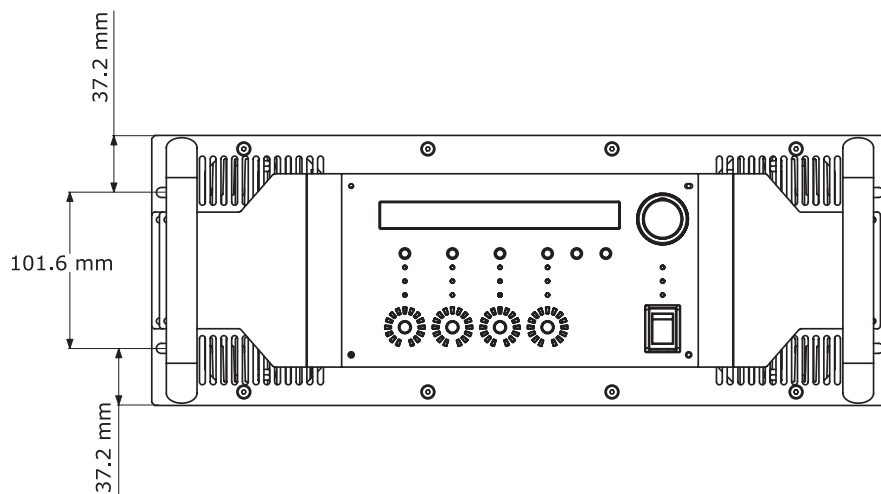

*NXAMP4X4 rack holes position*

With NXAMP4X1, because of this layout, it is not possible to use some rack rails with 2 holes per rack unit (see picture bellow), because you will loose  $\frac{1}{2}$  U of rack space on the top and bottom of the amplifier. Thus continuous rack rails or with 4 holes per rack unit should be used.

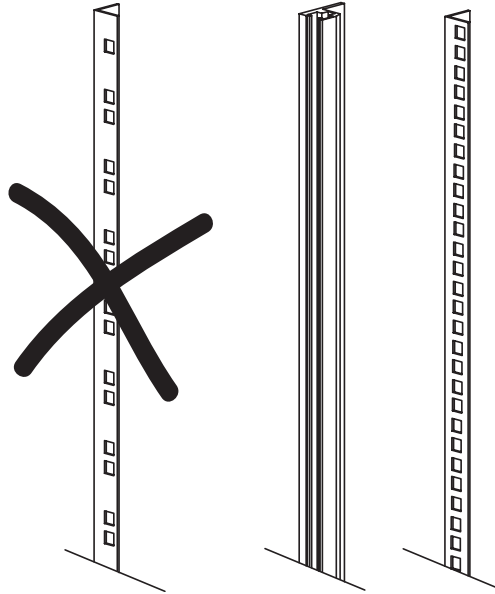

### Using the NXAMP without a rack

If you do not put the NXAMP into a rack, then it is mandatory to use the four rubber pads enclosed into the amplifier carton box. These auto adhesive pads should be stuck on each corner of the bottom of the amplifier. Without these rubber pads, some internal components can be damaged when there is a shock (for example dropping the amplifier on a table).

### Fuses



The fuses provided in the unit will not blow during normal operation. If one of the fuses blows it means that the Powered TDcontroller has malfunctioned. This fuse must only be changed by NEXO certified service personnel. In any case do not replace the fuse with a non-certified NEXO fuse, as this will invalidate the NEXO warranty.

#### CAUTION!

This servicing instruction is for use by qualified service personnel only. To reduce the risk of electric shock, do not perform any servicing other than that contained in the operating instructions unless you are qualified to do so.

### Electromagnetic environments

The emission (this word describes all types of electromagnetic noise radiated by the equipment) requirements which have been applied to Nexo's Powered TDcontrollers are the stringent requirements of the "Commercial and light industrial environment" of the product family EMC standard for emission.

The immunity (this word describes the ability to cope with electromagnetic disturbance generated by other items and natural phenomena) requirements that we have considered exceed those applicable to the "Commercial and light industrial environment" of the product family EMC standard for immunity. In order to provide a further safety margin, we recommend that you do not operate the Powered TDcontrollers in the presence of electromagnetic interference exceeding half of the limits found in this standard.

These two EMC standards are those applicable to pro-audio equipment for the implementation of the "EMC directive".

### Analogue input signal cables

Analogue signals should be connected to the input ports of the NXAMP Powered TDcontroller via shielded twisted pair or Starquad cable fitted with XLR connectors on the NXAMP side. We recommend the use of low transfer impedance cables with a braided shield and transfer impedance below 10 mΩ/m.

The NXAMP Powered TDcontroller is intended to be used with symmetrical (balanced) sources (for instance a mixer, see figure below). You can see that the TDcontroller provides a low impedance path between pin 1 of its XLR connectors and its chassis. The TDcontroller can sustain high current in pin 1 without degradation of output noise. We recommend that the sources and loads you use have the same desirable characteristics.

It is sometimes claimed that connecting cable shield at both ends creates ground loops, and that the current flowing in such loops will produce noise. This is not the case for most professional audio equipment. In short, there are two kinds of loops in which voltages are present: the loops formed by signal wires, and the loops formed by grounded conductors, among which are protective earth conductors (PE) and signal cable shields.

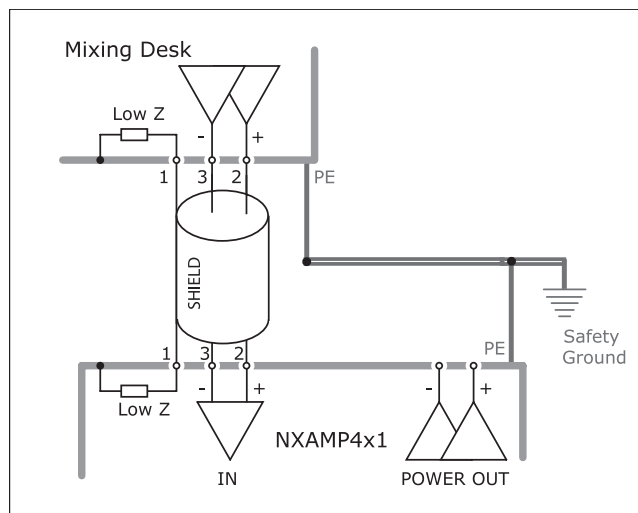

When a cable shield is grounded at both ends, a loop is closed, and the resulting current causes a reduction of the voltage induced on signal lines. This effect is what the cable shield is intended to produce, since this is how it protects your signal from magnetic fields.

If you are using an asymmetrical (unbalanced) source (not recommended), it is best to use a shielded twisted pair and to connect wire 3 of the cable to the shield at the source output end (see figure below).



SETTING-UP ADVICE

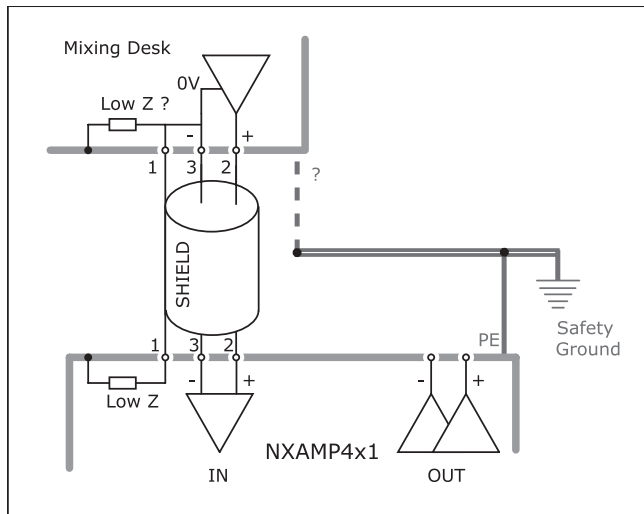

This technique prevents noise currents flowing on the return path of the signal. (Note that this is only acceptable for a short cable).

**NXAMP power outputs wiring**

NEXO recommends the exclusive use of multi-conductor cables to connect the system: the cable kit is compatible with all the cabinets, and there is no possible confusion between LF, MF and HF sections.

Cable choice consists mainly of selecting cables of the correct sectional dimension (size) in relation to the load resistance and the cable length. Too small a cable section will increase both its serial resistance and its capacitance; this reduces the electrical power delivered to the loudspeaker and can also induce response (damping factor) variations.

For a serial resistance less or equal to 4% of the load impedance (damping factor = 25), the maximum cable length is given by:

$$L_{max} = Z \times S \text{ S in mm}^2, Z \text{ in Ohm, } L_{max} \text{ in meters}$$

The table below indicates these values, for 3 common sizes.

Load Impedance (Ω)	2	3	4	6	8	12	16
<b>Cable section</b>	<b>Maximum Length (meters)</b>						
1,5 mm <sup>2</sup> (AWG #14)	3	4.5	6	9	12	18	24
2,5 mm <sup>2</sup> (AWG #12)	5	7.5	10	15	20	30	40
4 mm <sup>2</sup> (AWG #10)	8	12	16	24	32	48	64

**GENERAL DESCRIPTION**

**Global architecture**

**NXAMP4X1 Global architecture**

The diagram bellow shows the global architecture of the NXAMP4X1 amplifier.

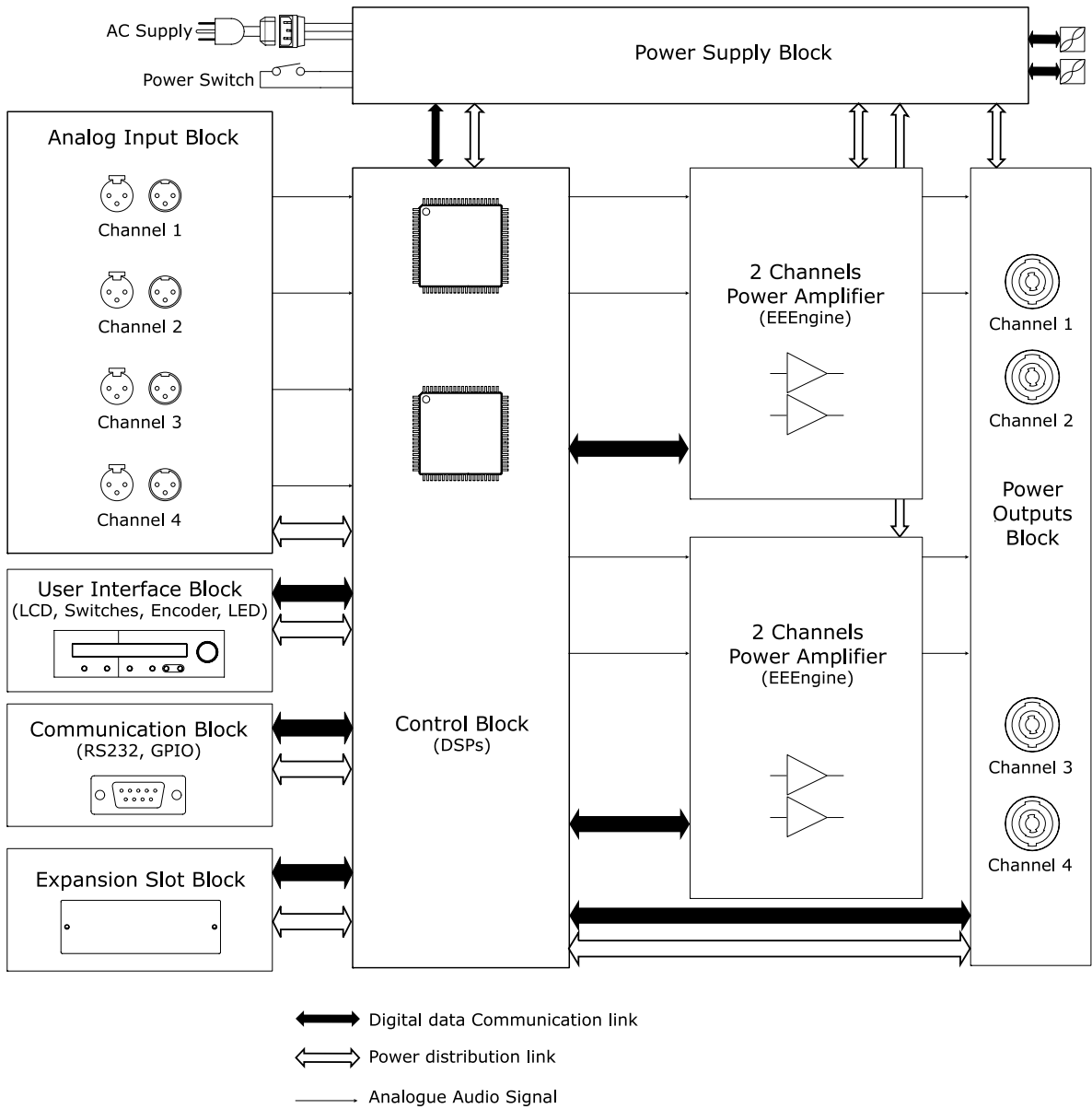

**NXAMP4X4 Global architecture**

The diagram bellow shows the global architecture of the NXAMP4X4 amplifier.

GENERAL DESCRIPTION

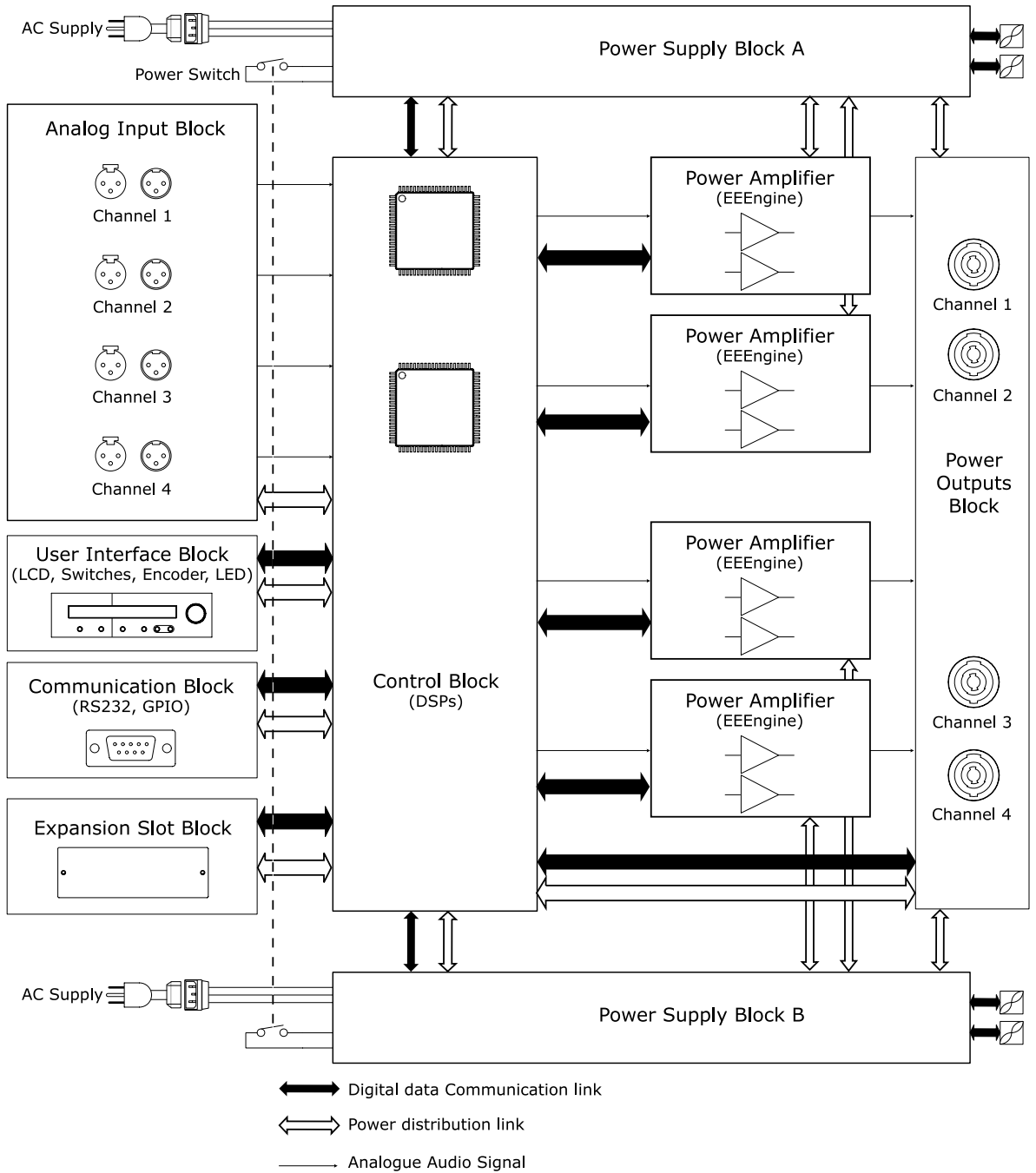

**Power Supply Block**

Power Supply is certainly the most important part of an amplifier. Most of the time, the Power supply is limiting the power of an amplifier, more than the amplifying circuit itself.

- On NXAMP4X1, two large power supplies are used, one for channel (1 and 2) and the other for channel (3 and 4).
- On NXAMP4X4, four large power supplies are used, one for each channel.

They all are full resonant type with half bridge converter. The ZCS (Zero crossing switches)

design ensures high efficiency and low noise. Moreover, because the two converters work in opposite phase, some noise is cancelled; this is preferable for both sound quality and EMC (Electro magnetic compatibility).

**Analog Input block**

After linking the two XLRs for each channel, the analog input block has an EMC filter and a precision input buffer that will remove the common noise on the input signal. The maximum level allowed for the input signal is + 28 dBu (55 Volts peak to peak). The pin out of the input XLR is given bellow.

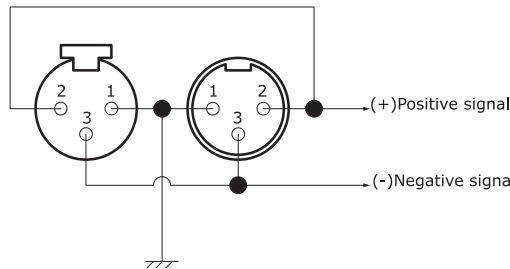

**Control block**

The control block contains several sub-block that are detailed bellow.

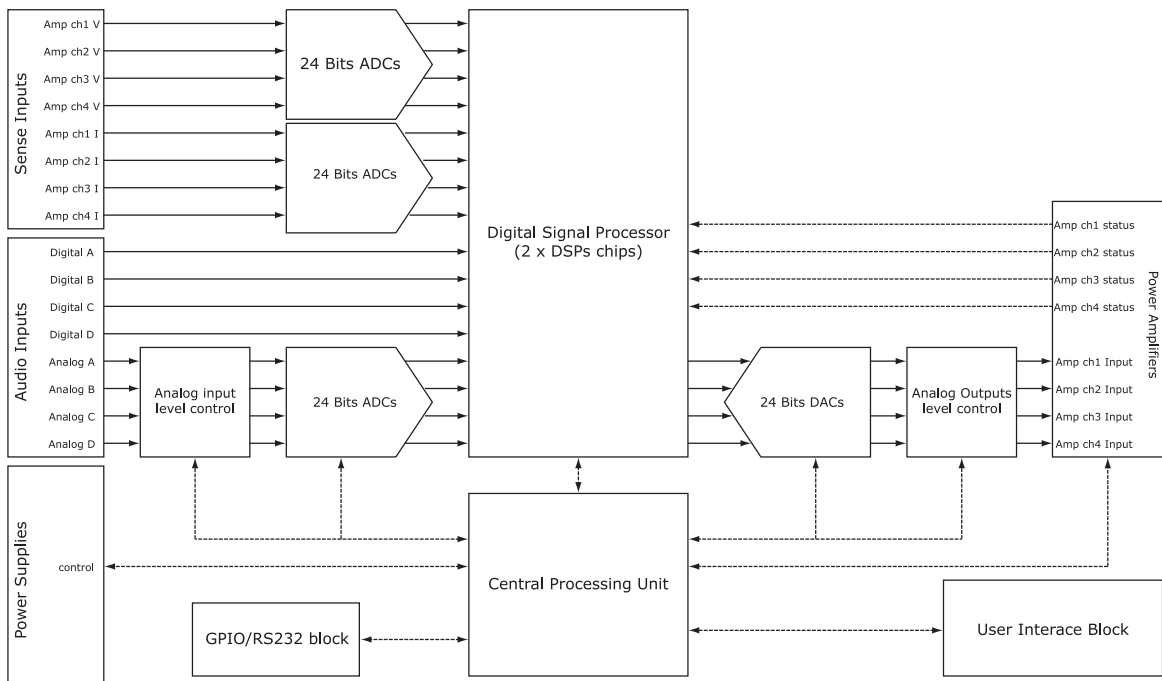

The plain lines show the audio or sense signal (sense are voltage or current signal measured at the output of each amplifier). The dashed lines show the digital communication signal among several block.

You can see the audio input on the left; there are four analog inputs (from input XLR) named Analog A, Analog B and so on... and four digital inputs (Digital A, Digital B and so on...) from the expansion slot. These eight signals can be patched inside the DSP to any

channel of processing/amplifying (see further for a block diagram of what is inside the DSP).

All signals, audio or sense, use 24 bits converters. The CPU can also set up the analog input and output gain for each channel, thus ensuring that the dynamic range of the system is always optimized (regarding volume, gain, patch and bridge settings).

Monitoring of the amplifier modules and power supplies (including multiple measurement such as temperature, voltages, current, integrate current ...) are done both by the CPU and the DSPs.

**Power amplifier blocks**

The power amplifier part is a custom design to fit the very unique concept of digital protection of an analog amplifier. On the pure amplification side, it utilizes custom transistor (thin chip and small thermal resistance), and the well known Yamaha EEEngine technology, that offers the sonic quality of the conventional class AB amplifier with the efficiency of the class D. You can learn more about the EEEngine technology at the following address:

[http://www.yamahaproaudio.com/topics/leading\\_technology/learn\\_more\\_about\\_eengine/index.html](http://www.yamahaproaudio.com/topics/leading_technology/learn_more_about_eengine/index.html)

**Power outputs block**

The power outputs block is used for current and voltage sensing at the output of the amplifier. These datas will be used by the DSP for protecting both the amplifier and the NEXO loudspeaker connected. This stage features also a programmable routing unit that allows using the amplifier in bridge mode on the same speakon pins than in non bridge mode.

When using the NXAMP Powered TDcontroller in four channels mode, here is the output routing:

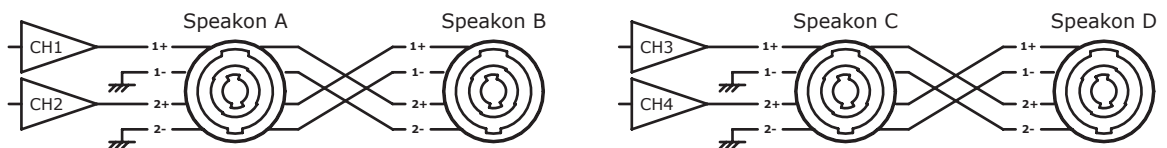

Note the symmetrical structure between channels 1/2 and channels 3/4.

When using the NXAMP Powered TDcontroller in bridge mode, here is the output routing:

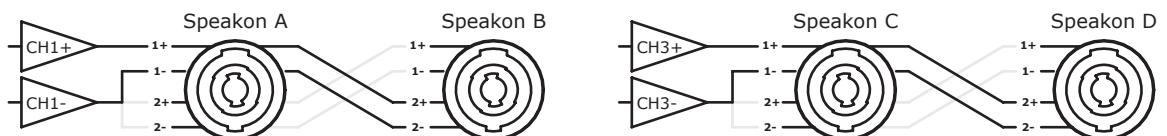

Now amplifier channel 1 and 2 works together in bridge mode (channel 2 is marked "CH1-" above). This is same for channel 3 and 4. The pin-out on the speakon is the same as the channel 1 and 3 in non bridge mode, thanks to the programmable routing unit (not drawn here).



You can see with the gray line on the above drawing that unused pins on output speakon are shorted together, but are not connected to ground. Therefore be careful as very high voltage might be present on these unused pins.

### User interface block

The user interface block has already been described through the front panel description in the first part of this document. Please note that all the commands and displays are available through the ESmonitor software by Auvitran, through the Ethersound™ network (except the mains switch).

### Communication block

The communication block regroups the RS232 port (on a sub-D9 plug) and the GPIO port (on a sub-D25 plug).

The RS232 port is mainly used to upgrade the firmware of the unit from a PC computer. But it could also be used in the future for local communication with other equipments. The pin-out is given below:

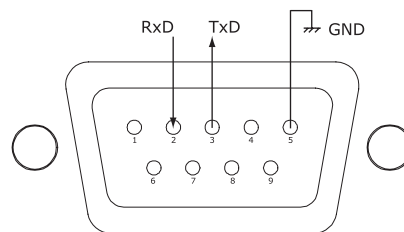

View from the back of the amplifier

The RxD pin is the "Receive data" pin from the NXAMP point of view. Thus this is an input. The TxD pin is the "Transmit data" pin from the NXAMP point of view. Thus this is an output. GND is the ground.

A crossover cable (connecting RxD pin of NXAMP to TxD pin of computer, and so on) is needed to use this serial port. Please see further the dedicated part of this document on that subject.

The GPIO port is a Global Purpose Input/Output signals system that can be use for a wide range of application, mainly interfacing the NXAMP with security systems. There are the following signals available:

- 8 x General purpose output signals from NXAMP (5 Volts signals)
- 5 x General purpose input signals to NXAMP (5 Volts signals)
- 4 x 5 Volts outputs
- 8 x GND (ground) signals.

The pin out of these signals is given below:

## GENERAL DESCRIPTION

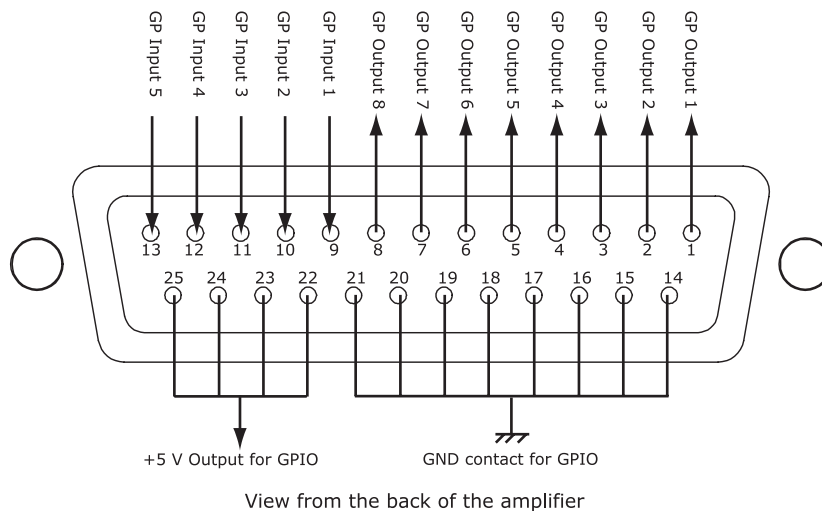

It is mandatory to have a galvanic isolation between these signals and any another equipment. Thus, either the target equipment should present isolated GPIO system, or the signal should goes through small signal relays to guarantee that the NXAMP GPIO will be isolated from the other equipment.



The maximum current available on the GPIO port is the following:

- Maximum 200 mA drawn from the totality of the +5 V outputs.
- Maximum 200 mA drawn from the totality of the GP Outputs, with a maximum of 32 mA for each output.

### Expansion slot block

The expansion slot uses unique 80 pins connectors that will allow the user to simply fit an expansion board into the amplifier. At the moment, the only expansion board available is the NXES104 Ethersound™ board (compatible with the ES-100 standard, offering full remote control from a computer running ES monitor by Auvitran application, and 4 channels of 24 bits 48 KHz audio).



NEXO expansion slot form factor is not compatible with the Yamaha mini-YGDAI form factor. Thus, Yamaha mini-YGDAI card cannot be fitted inside NXAMP Powered TDcontroller.

Since July 2009, all NXAMP4x1s and NXAMP4x4s are shipped with an expansion card fitted in, the NX-DFLT card. This card prevents output noises when main AC power feeding NXAMPs is brutally shutdown (ie power down at the end of the show before NXAMPs are switched off). NX-DFLT card should always be fitted in when no other expansion card is used.

**Block diagram description**

The block diagram bellow shows the global signal path inside the DSPs, for one channel (identical for all the channels):

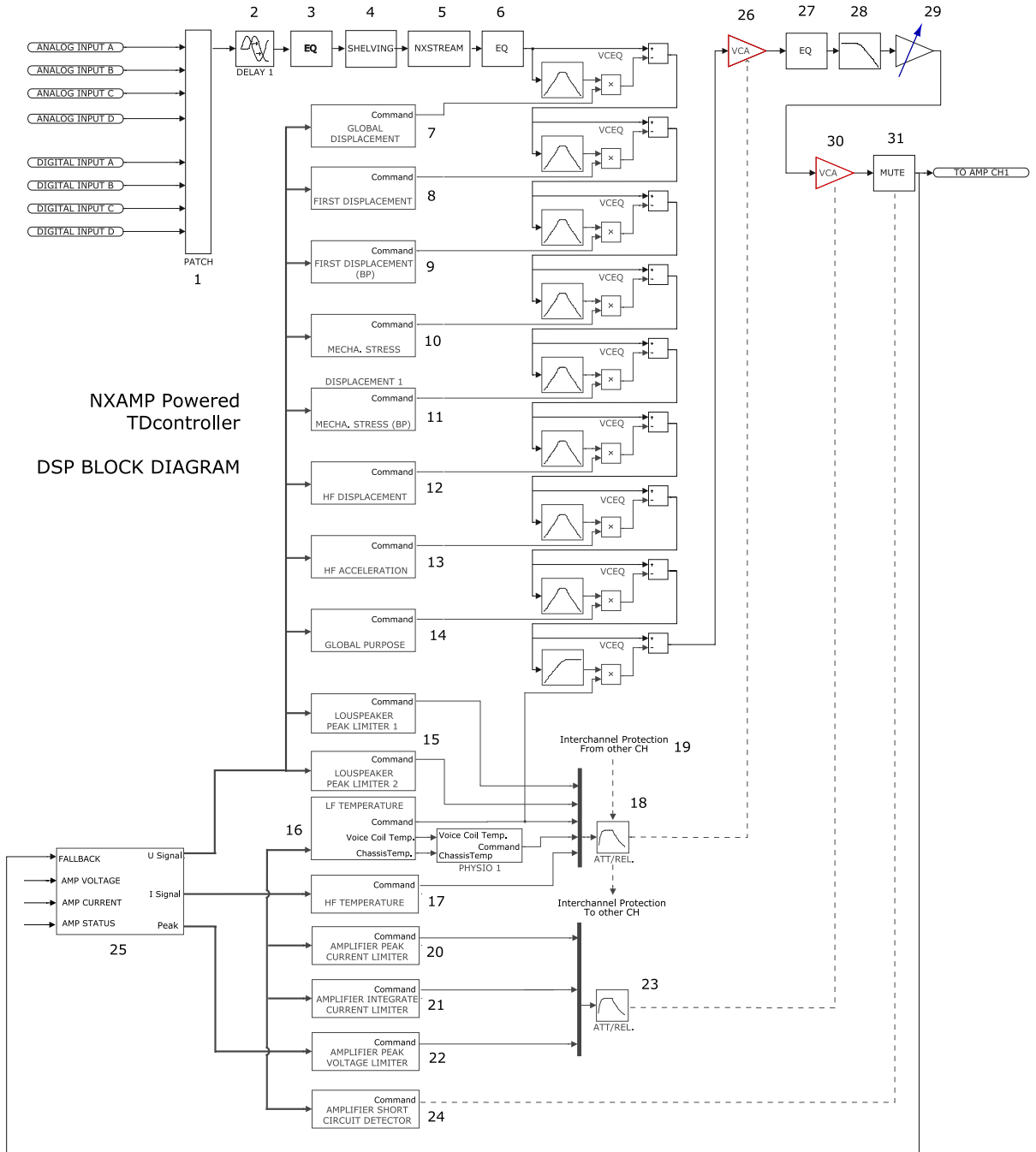

The detail of each block numbered is given bellow.



## Patching and routing (1)

Basically, any combination of the four XLR analog inputs (numbered A to D on the back panel) can be patched to each channel of the amplifier. If an expansion board is fitted, the four added digital input (numbered A to D also) can be mixed as well. In this patch section, digital gain and adjustment delay are also added to optimized signal to noise on the audio path and to ensure propagation delay equal to NX242 TDcontroller.

*N.B.: There is no reason why analog and digital input should be in phase, so we recommend a great care when patching both analog and digital input to the same channel (it should be done most of the time only as a backup solution, to ensure analog feeding to the amplifier instantaneously instead of digital input for example if the digital input goes down).*

## Delay & polarity inversion (2)

### Factory set-up delay

Note that each output may contain a small phase adjustment delay at the crossover point. Also, a polarity inversion may be performed. These adjustments are part of the factory set-ups and are necessary to time-align the corresponding cabinet that is selected.

### User set-up delay

The user can adjust the delay for each channel (see further about the delay menu, or delay setting from the ESmonitor). The maximum delay allowed is 66.6 meters per channel.

*N.B.: This user delay will be added to the converter latency, DSP buffering latency and factory set-up delay.*

The NXAMP TDcontroller will limit the delay adjustment to a group of channel in specific case such as:

- Active setups where two different channels are in the same physical cabinet: it is then impossible to delay one channel without the other one (for example PS15 Active setup, delay is linked between HF and LF).
- Cardioids setups will also prevent to adjust the delay on one channel only (for example CD18 setup, delay is linked between front and rear loudspeaker).

## Equalisation & Filtering

### Subsonic and VHF filtering (3)

Low and high-pass filters are used to filter out frequency components that could possibly degrade the performance of the NXAMP Powered TDcontroller and loudspeakers connected (depending on the cabinet setup chosen). The filters are optimised to work in conjunction with overall system response.

The high pass filters are also extremely important as they optimise excursion at very low frequency which is a very important safety factor. (Therefore do not use set-ups which are not designed for the cabinet you are using).

### **Equalising wideband acoustical response (3)**

This wideband equaliser section achieves the correction required to obtain a flat system response, as the cabinets are acoustically designed for maximum efficiency on the whole frequency range. Active rather than passive attenuation allows the lowering of amplifier voltages for a given output SPL and therefore increases the maximum SPL achievable with the same amplifier. Active equalisation also extends system band pass especially at low frequencies where acoustical performance is limited by cabinet size.

### **User set-up, Array EQ (4)**

For each channel, an Array EQ is currently implemented in the NXAMP. The cut off frequency of a low-shelving filter is factory tuned for each cabinet set-up. The user has access to the gain of this filter. The array EQ is tuned in order to reproduce the effect of the bass coupling, allowing the user to increase or diminish the effect of the stacking (see further about the Array EQ menu, or Array EQ setting from ESmonitor).

### **Equalising single component response and NXSTREAM processing (5)**

This equaliser set allows acting on a specific driver after the crossover, rather than on the wideband section. This allows to EQ one driver without affecting the others (cleaning out of band response, fine tuning in a crossover...). All the parameters are factory set.

Last generation of NXSTREAM algorithm are also implemented in this section. This process uses sophisticated DSP program to go beyond the limits of the conventional EQ filtering, to manipulate for example the phase of the audio signal independently of the amplitude and so on.

### **Crossover section (6)**

Crossover between different bands is tuned for every set-up of every cabinet. Each crossover is customized so that each transducer will fit with its neighbor by achieving a perfect phase alignment. Unconventional, crossover-defined filters are applied, ranging from 6dB/octave to near infinite slopes according to the type of crossover desired. Time alignment is also unconventionally achieved, by combining crossover filter group delays with all-pass and/or frequency dependent delays.

### **Post protection EQ and low pass (27) (28)**

After the Protection block (using VCEQ and VCAs, see bellow), another set of EQ / low pass filtering is applied to remove some artefacts due to protection algorithm on some speaker setups.

### **Gain section (29)**

In this section the digital gain is applied to the corresponding channel. This digital gain is computed by the CPU and depends on the user gain, the setup gain for the channel, and the optimization of the gain ranging done by the CPU.

The NXAMP TDcontroller will limit the user gain adjustment to a group of channel in specific case such as cardioids setups (for example on CD18 setup, gain is linked between front and rear loudspeaker).

## **Protections**

Each channel has its own simulation and protection process. Each audio channel contains a combination of controlled gain stages (let's call them VCA's as in our analogue circuitry). These VCA's are embedded into complex composite structures in order to change their basic operation into frequency selective attenuation. This operation is similar to that of a voltage controlled dynamic equaliser (VCEQ).

Each VCEQ and VCA is controlled by the synthesis of several signals issued from the various detection sections. That synthesis is in fact the envelope of those signals, with an optimised release and attack time for each VCEQ and VCA (depending on its frequency range and the cabinet selected).

One or several of the protections below can be used depending on the setup chosen.

### **Source signals for protection algorithms (25)**

Signals coming from amplifier output voltage/ current, processor output, and status from amplifier are all sources that will lead to protection system implementation.

### **Displacement control (7) (8) (9)**

The amplifier output voltage sense input signal is sent to a shaping filter producing a signal whose instantaneous amplitude is proportional to the voice coil excursion (this is Global displacement block (7)). This signal, after rectification, is compared to a preset threshold matching the maximum usable value, as determined from laboratory measurements. Any part of the signal exceeding the threshold is sent to the VCEQ control buffer while the VCEQ acts as an instantaneous limiter (very short attack time) to prevent displacement from overriding the maximum permissible value.

Another set of VCEQ (this is first displacement block (8)) is used to protect the loudspeaker from an excessive displacement in the next worst displacement frequency area (this usually is 3 dB below the global displacement protection area). In case of band pass cabinets, we need another set of VCEQ (this is first displacement band pass block (9)) to protect from another peak of secondary displacement.

All these VCEQs have separate shaping filter, separate action filters for VCEQ, and separate Ratio, Attack and Release time.

### **Mechanical stress control (10) (11)**

Whereas some frequency areas are dangerous at high level due to excessive displacement of the loudspeaker (see above), there is another area where the displacement of the loudspeaker is minimum, but then the mechanical stress on the cone during large input signals is maximum.

To protect from overstressing the loudspeaker, VCEQ process can also be used in these

particular area (this is block (10)). As with displacement VCEQ, another set of mechanical stress VCEQ is needed for band-pass cabinets (this is block (11)).

### **HF displacement control (12)**

In case of passive setups, a channel will deal with several loudspeakers after passing through the passive filter of the cabinet. That is why, as previous VCEQs deal with LF loudspeaker, another set of VCEQ is needed to protect HF driver from excessive displacement.

### **HF acceleration control (13)**

Excessive acceleration on the HF driver can lead to the destruction of the diaphragms. Another set of VCEQ is added here to protect HF driver from over acceleration.

### **Global purpose VCEQ (14)**

The internal structure of the VCEQs processes inside the DSP allow up to eight different VCEQ, in case you need extra VCEQing for dynamic EQ or whatever...

### **Loudspeaker Peak limiters (15)**

These "loudspeaker" peak limiters are here to avoid huge amounts of power being sent to a driver. Each driver is protected in temperature and displacement but there could be other factors of destruction that cannot be predicted by simulation (especially mechanical damage to the cone...). Each driver is specified for a certain power handling and a factory set peak limiter threshold is tuned to avoid any abuse. A two-steps peak limiter is used here, each with a separate set of threshold, ratio, attack and release.

### **Temperature control (16) (17)**

The sense signal from amplifier output is fed into a shaping filter, each one producing a signal proportional to the instantaneous current flowing into the voice coil of the transducer. After rectification, this signal is integrated with attack and release time constants equivalent to the thermal time constants of the voice coil and chassis, producing a voltage, which is representative of the instantaneous temperature of the voice coil.

When this voltage reaches the threshold value corresponding to the maximum safe operation temperature, the VCA or the VCEQ becomes active to reduce the Audio signal level and limit the effective temperature to fall under the maximum usable value.

In order to avoid detrimental effects induced by very long release time constants coming from the temperature detection signal (level being reduced for an extended period, « pumping » effects...), the detection signal is modulated by another voltage integrated with faster time constants matching the sound level subjective perception. This allows the controller to reduce the effective operation duration of the temperature limiter and make it sound more natural, while the efficiency of protection is fully preserved and operation thresholds are unaffected (kept as high as possible).

In case of passive cabinet, another set of temperature simulation is done to protect the H.F. driver; this is block (17).

The so-called Physiologic Dynamic Control (see block diagram) is intended to avoid unwanted effects as a result of a too long attack time constant. By anticipating the operation of the temperature limiter, it prevents a high level Audio signal appearing suddenly then being kept up for a period, which is long enough to trigger the temperature limiter. Without this, a rough and delayed gain variation would result which would be quite noticeable and unnatural.

The Physio control voltage acts independently on the VCA with its operation threshold slightly lower (3 dB) that of the temperature limiter and a low compression ratio; its optimised attack time constant allows it to start operating without any subjectively unpleasant transient effects.

### **Interchannel regulation (19)**

As described before, each transducer is individually servo-controlled for temperature. This means in practice that, in case of a potential risk detected, protective operation would only affect the concerned driver. Your driver will be protected but the overall system tonal balance could be altered if the different channels are not heating at the same time. In addition, triggering a temperature protection means that the loudspeaker has already lost some efficiency (power compression up to 3dB in extreme cases)

The purpose of interchannel regulation is to cancel that effect by linking VCAs together. When the protection is activated on one channel and reaches a predetermined threshold, the regulation section begins to correct the balance between the different channels (HF, MF, and LF) by acting on the concerned VCA.

### **Amplifier peak current limiter (20)**

To prevent over-current on the output of the amplifier, this peak current limiter is implemented, leading to a separate VCA (block (30)) from the one being used for loudspeaker protection (block (26)). This protection is implemented here mostly in case of default of the power supply, and will barely be triggered during normal use, because it is set up at the limit of what can deliver the power supply of the amplifier.

### **Amplifier integrate current limiter (21)**

This protection which is also triggering a VCA will compute the integration of the current over time to check that the current drawn by the amplifier will not go above what is acceptable for the mains. With musical signal should never trigger this protection, mainly implemented for protection against continuous signal like sine wave and so on.

### **Amplifier peak voltage limiter (22)**

This is a "soft clip" limiter that will reduce the output level through a VCA process to limit the clipping of the amplifier.

### **Amplifier short circuit detector (24)**

If a short circuit is detected on the output, the amplifier will mute itself, and will release the mute a few second after automatically. This is shown on the front panel by a blinking of the peak LED of the concerned channel, together with the "Amp protect" LED.

**MENU DESCRIPTION**

The diagram bellow shows the internal structure of the menus accessible by the user from the front panel. Follow the arrow corresponding to the "A" or "B" button for each menu to enter the next one.

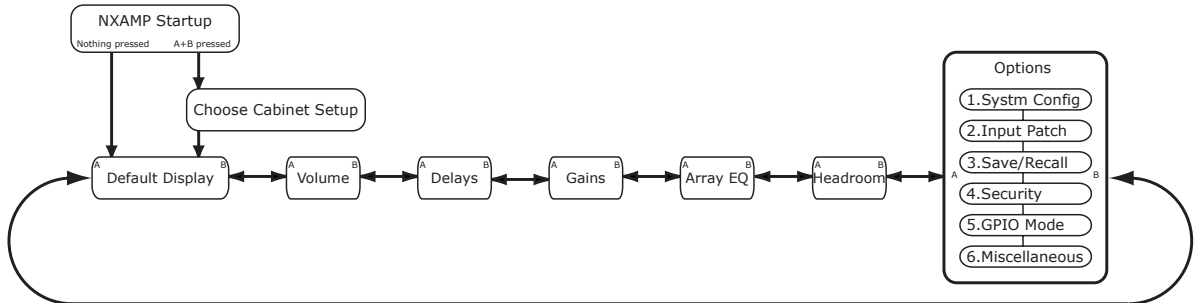

Default display is the display of the current setup number (each setup has a unique number inside for each LOAD revision) and setup name (see picture bellow). After two minutes of inactivity, the display will go back to the default display.

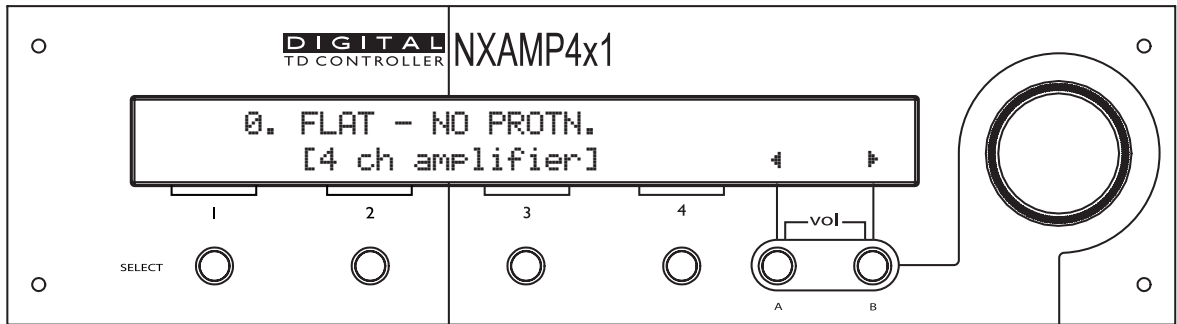

**Changing Cabinet Family**

In order to prevent end-user changing between different NEXO systems set-ups during use, the following procedure is recommended. This procedure has been purposely designed to avoid any mistakes. It is nevertheless very easy to change set-up among the same family or between families (see further, "System config").

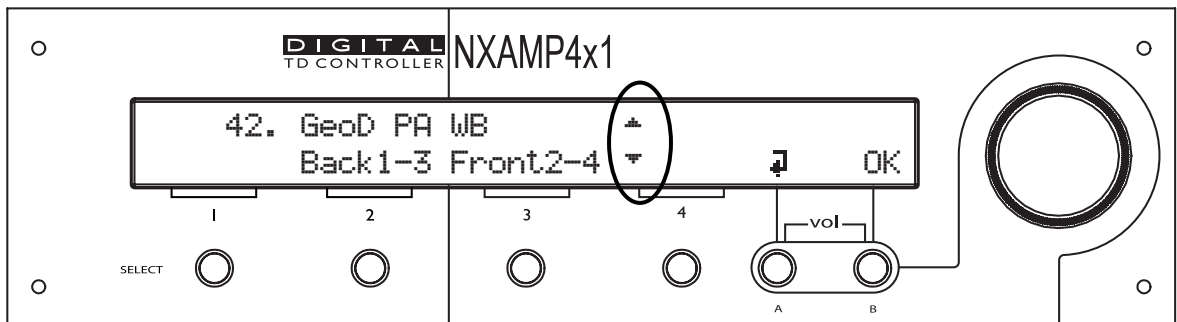

Repressing A & B buttons while the NXAMP is starting (this last 2 seconds). At the end of the boot time, the above screen should appear, while the amplifier part itself starts up (this last around 18 seconds, and ends when you hear the output relays moving and see the "Amp Protect" LED shutting down). Please note that you don't need to wait for the amplifier to start for choosing your cabinet setup.

You should then see the two up and down arrows surrounded in the above drawing. This means that you can change the speaker setup by turning the wheel. Select the appropriate setup by pressing "OK" (button B) or press the button A to go back to current setup without changes.

*N.B.:* You can reset the unit without powering off by simultaneously repressing buttons A, B & SELECT CH1 at the same time for at least 3 seconds.

*N.B.:* The setup number is blinking when the currently displayed setup is different from the one running into the DSP at the moment.

Note: Selecting a new family will set all parameters to factory default settings.

*N.B.:* The setup number 0 "FLAT -NO PROTN." is the default setup; it means no EQ (Flat) and no protection (No protn.) for the speakers but of course amplifier protections will still work.

### Adjusting Volume

The volume of each channel can be adjusted from the Volume menu (unit is dB). Bellow is a picture of this menu.

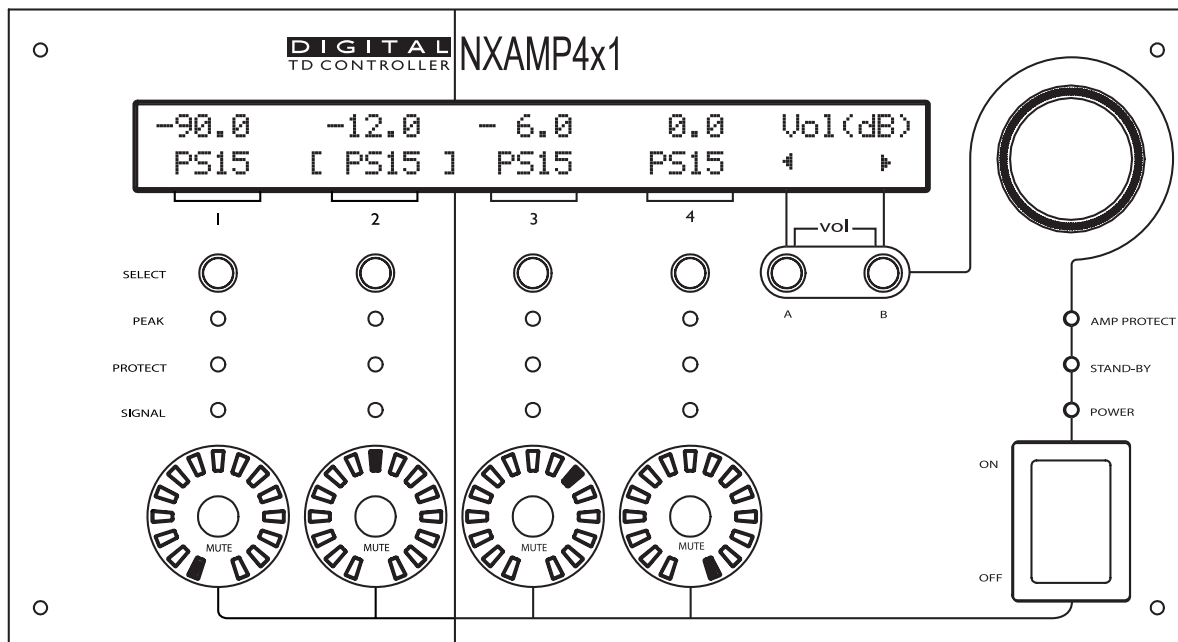

The volume setting for each channel can always be clearly seen from the front panel surrounding LED (white/blue) around each mute button. The position of the LED gives the value of the volume, like it would be for a traditional analog volume pot. The picture bellow gives the attenuation value for each LED.

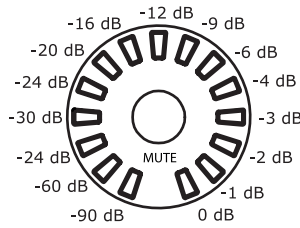

The attenuation value can also be read on the LCD screen. To change the attenuation for a given channel, select the channel first by pressing the corresponding "select" button. The channel name on screen will then be put between bracket (see on the picture above, channel 2 is selected). Then turn the wheel to change the volume setting.

You can select multiple channels by pressing several "select" buttons at the same time. When a selected channel reaches the maximum value, it will cease to increase by continuing to turn the wheel, but other selected channels may still increase the setting: be careful not to change a gap between two channel settings when selecting multiple channels at the same time.

Please note that all the LEDs for volume indication are white except the last one (corresponding to 0 dB attenuation) which is Blue. That allows to quickly checking that all volumes are correctly set on a NXAMP powered TDcontroller.

*NB: You can adjust small differences of gain between channels with the gain menu (see further). There is basically no difference between volume setting and gain setting for a channel, this distinction is only done by analogy with traditional amplifiers. The CPU will always take care of gain and volume settings and decide what the best combination is between analog or digital gain to optimize dynamic range of the system.*

### Adjusting Delay

The delay of each channel can be adjusted from the Delay menu. Bellow is a picture of this menu.

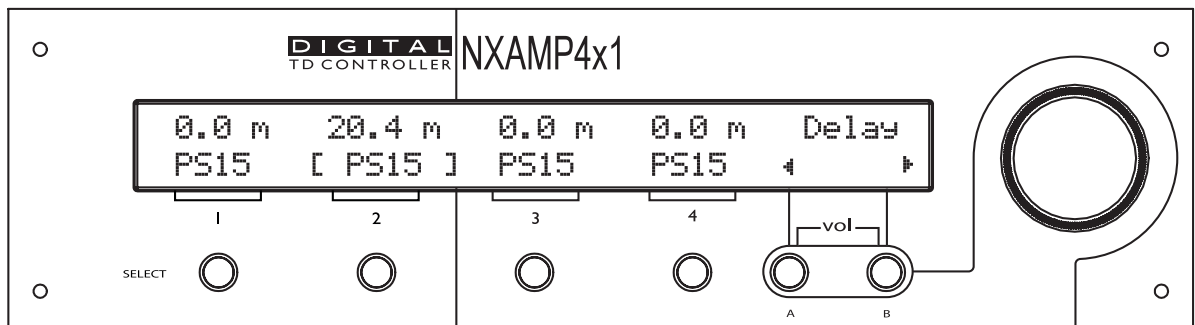

The delay value can be read on the top of the LCD screen for each channel (unit is meters). To change the delay for a given channel, select the channel first by pressing the



corresponding "select" button. The channel name on screen will then be put between bracket (see on the picture above, channel 2 is selected). Then turn the wheel to change the delay setting (maximum delay is 66.6 meters).

You can select multiple channels by pressing several "select" buttons at the same time. When a selected channel reaches the maximum value, it will cease to increase by continuing to turn the wheel, but other selected channels may still increase the setting: be careful not to change a gap between two channel settings when selecting multiple channels at the same time.

In some special situation (active setups in same enclosure for example, like PS15 active) it is mandatory to have same delay settings on two or more channels. Then, changing the delay on one of these channels will automatically adjust the delays on the other channels.

## Adjusting Gain

The gain of each channel can be adjusted from the Gain menu. Bellow is a picture of this menu.

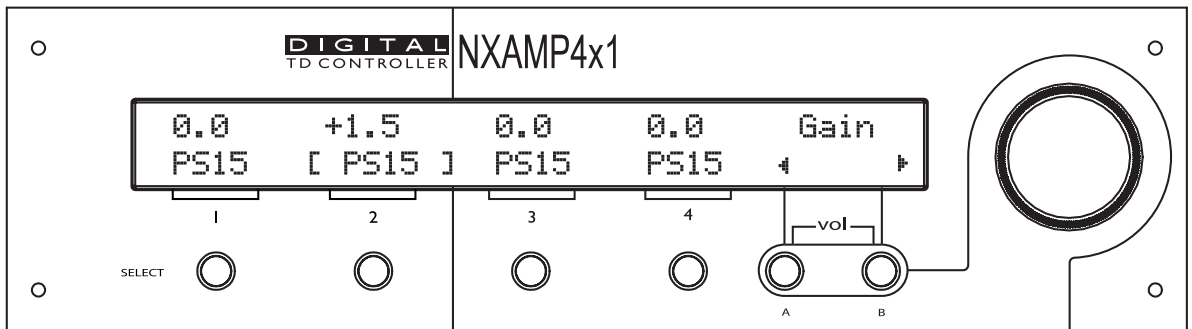

The gain value can be read on the top of the LCD screen for each channel (unit is dB). To change the delay for a given channel, select the channel first by pressing the corresponding "select" button. The channel name on screen will then be put between bracket (see on the picture above, channel 2 is selected). Then turn the wheel to change the gain setting (from - 6 dB to + 6 dB).

You can select multiple channels by pressing several "select" buttons at the same time. When a selected channel reaches the maximum value, it will cease to increase by continuing to turn the wheel, but other selected channels may still increase the setting: be careful not to change a gap between two channel settings when selecting multiple channels at the same time.

In some special circumstances (cardioids setups for example) it is mandatory to have same gain settings on two or more channels. Then, changing the gain on one of these channels will automatically adjust the gains on the other channels.

*NB: You can adjust large differences of gain between channels with the volume menu (see above). There is basically no difference between gain setting and volume setting for a channel, this distinction is only done by analogy with traditional amplifiers. The CPU will always take care of gain and volume settings and decide what the best combination is between analog or digital gain to optimize dynamic range of the system.*

### Adjusting Array EQ

The Array EQ of each channel can be adjusted from the Array EQ menu. Bellow is a picture of this menu.

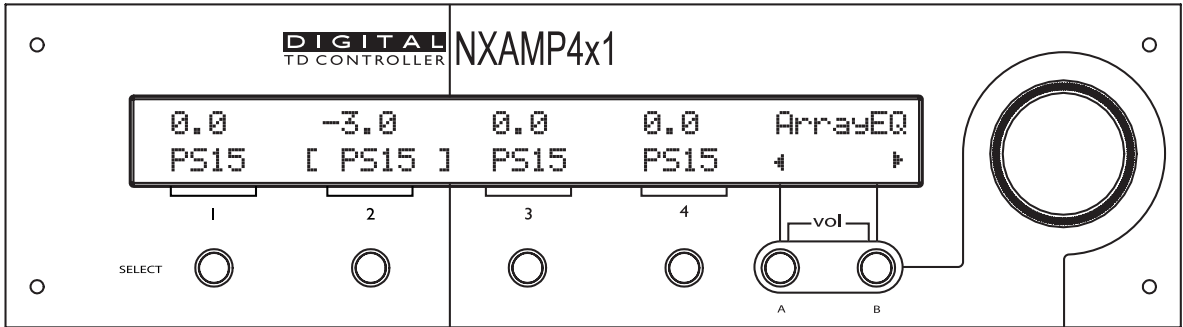

The Array EQ value can be read on the top of the LCD screen for each channel (unit is dB). To change the Array EQ for a given channel, select the channel first by pressing the corresponding "select" button. The channel name on screen will then be put between bracket (see on the picture above, channel 2 is selected). Then turn the wheel to change the Array EQ setting (from - 6 dB to + 6 dB).

You can select multiple channels by pressing several "select" buttons at the same time. When a selected channel reaches the maximum value, it will cease to increase by continuing to turn the wheel, but other selected channels may still increase the setting: be careful not to change a gap between two channel settings when selecting multiple channels at the same time.

In some special circumstances (cardioids setups for example) it is mandatory to have same Array EQ settings on two or more channels. Then, changing the Array EQ on one of these channels will automatically adjust the Array EQ on the other channels.

### Adjusting Headroom

The headroom of each channel can be adjusted from the headroom menu. Bellow is a picture of this menu.

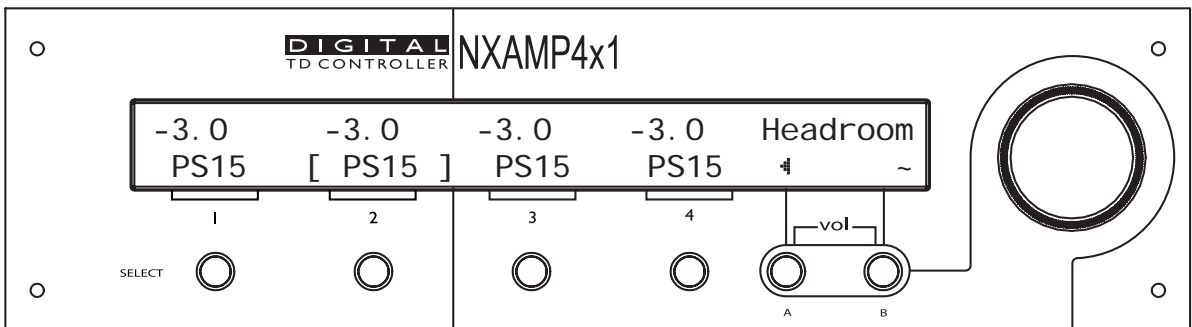

The headroom value can be read on the top of the LCD screen for each channel (unit is dB). To change the headroom for a given channel, select the channel first by pressing the corresponding "select" button. The channel name on screen will then be put between

bracket (see on the picture above, channel 2 is selected). Then turn the wheel to change the headroom setting (from - 12 dB to 0 dB).

You can select multiple channels by pressing several "select" buttons at the same time. When a selected channel reaches the maximum value, it will cease to increase by continuing to turn the wheel, but other selected channels may still increase the setting: be careful not to change a gap between two channel settings when selecting multiple channels at the same time.

In some special circumstances (cardioids setups for example) it is mandatory to have same headroom settings on two or more channels. Then, changing the headroom on one of these channels will automatically adjust the headroom on the other channels.

**Headroom concept**

The headroom settings adjust the input/output analog gain to ensure the best matching between program material and NXAMP internal gain structure.

With heavy content, like open air rock concert, you will need the full input range sensitivity. This is the most typical situation. In that case, the headroom should be adjusted to 0 dB.

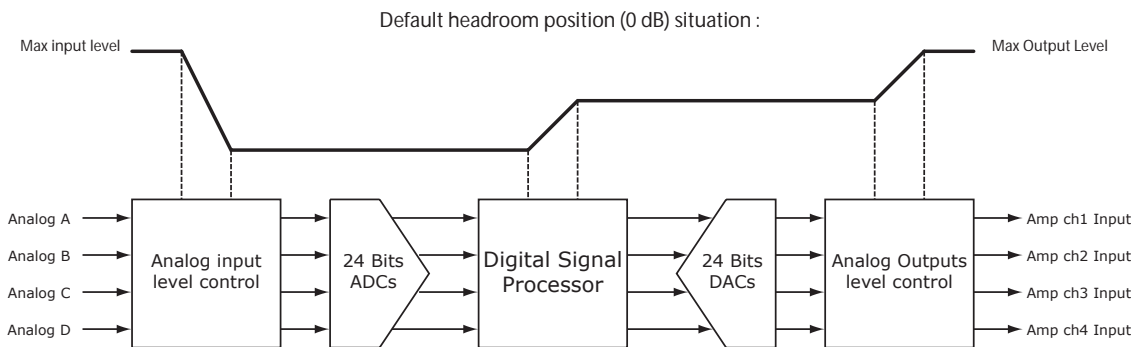

Example above shows large input attenuation and large output gain. Overall gain is 0 dB (before amplifier).

But in quiet environment, like background music or small acoustic set, you won't use the full dynamic of the NXAMP input converter. In that case, you can lower the headroom value, meaning that the input headroom of the amplifier is reduced; thus improving the effective resolution used on the analog to digital input converter.

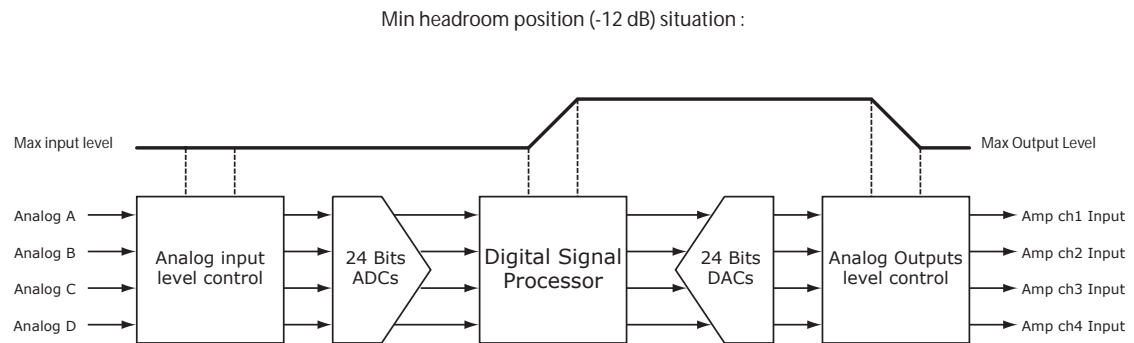

Example above shows small input attenuation and small output gain. Overall gain is 0 dB (before amplifier).

In the same time, the output (analog or digital) gains of all the channels are automatically adjusted to keep the same overall gain from inputs to outputs of the NXAMP.

Advantage of reducing the headroom is that it adapts the resolution of the converters to the scale of the analog input signal, thus improving background noise and reducing distortion.

Drawback of reducing the headroom is that you may clip the converters before clipping the amplifier, thus virtually reducing the output power of the amplifier. Thus when adjusting the headroom, be sure to always use program material that matches the actual program that will be played, and check that the Peak LED for this channel is not starting to blink at a lower level than before; if yes, it means that you are lowering the maximum output of the amplifier because of a too low headroom, then increase the headroom.

**Default headroom position (0 B) should be considered for most application. If you are not sure of how to adjust headroom, leave it to the default position (0 dB) which is the safest position.**

*Note: Because same analog input signal can be routed to several outputs, it is always best to use same value of headroom on all channels, or to use separate analog input to various outputs (using link at the back of the amplifier if needed). Using different values of headroom on channels using same input can reduce or cancel the effect of the headroom.*

*Note: Headroom effect is compensated on the digital inputs using digital gain.*

*Note: Software peak limiter prevents hard clipping of the converters if needed in case of reduced headroom value; thus gentle lighting of the Peak LED can be authorized without sound quality issue.*

## Options Menu

With this menu you can enter some sub-menu to adjust parameters of the NXAMP does do not need to be changed during the normal use of the amplifier (mainly during setup of the unit only). Below is a picture of this menu.

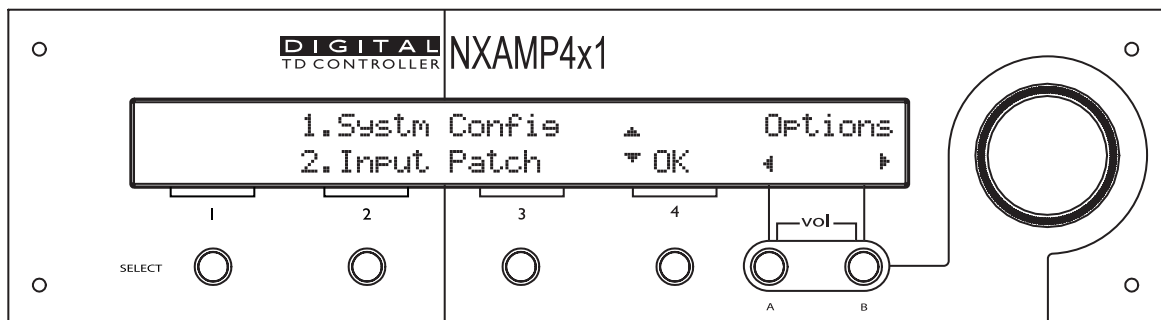

The sub-menu located on the top of the screen will blink (here it is 1.System Config). Depressing "select" of channel 4 will enter this sub-menu ("OK" is displayed on the screen align with "select" 4 button). Turn the wheel to select another sub-menu. When coming back to the Options menu later, the last selected sub-menu will be displayed first.

**System config**

This menu allows changing between several speaker setups inside a same family or even through any family, even if this last solution is not recommended. Same family means that same cabinet are connected to same outputs of the amplifier. Mainly this menu is for comparing quickly to setup (Wideband and Crossover for example) without restarting the amplifier. To enter this menu, go to the OPTION menu, and display Bellow is a picture of this menu. First step to change the input patch is to go to the OPTION menu (see above), then select the sub-menu "1.System Config".

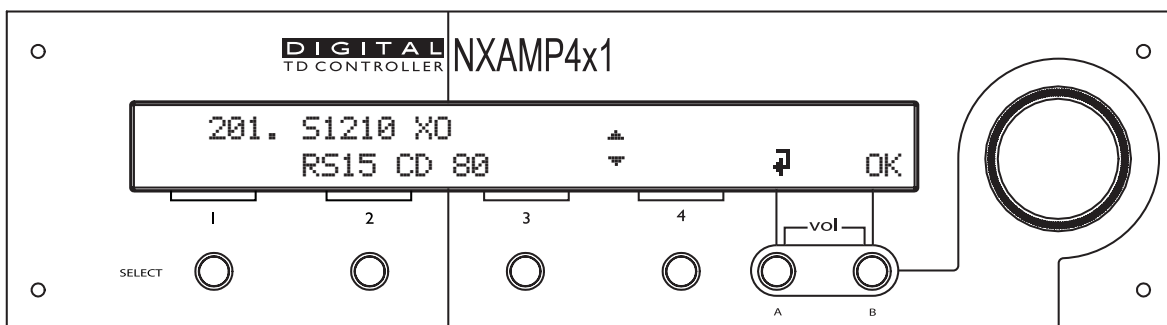

Select one speaker setup by turning the wheel till the setup number appears blinking on the LCD screen (in this example, you can toggle between the Crossover (Xover) and the Wide setup). Then depress the "B" button (OK). Once the setup is loaded, the amplifier will go back to the default screen. If you don't want to change the current speaker setup, simply press the "A" button (Back).

If you want to recall a setup from another family, you should first go to the last setup of the current family, meaning that the setup number cannot increase when turning the wheel. You will then see the mention "All" appearing in front of the 'Select 4' switch.

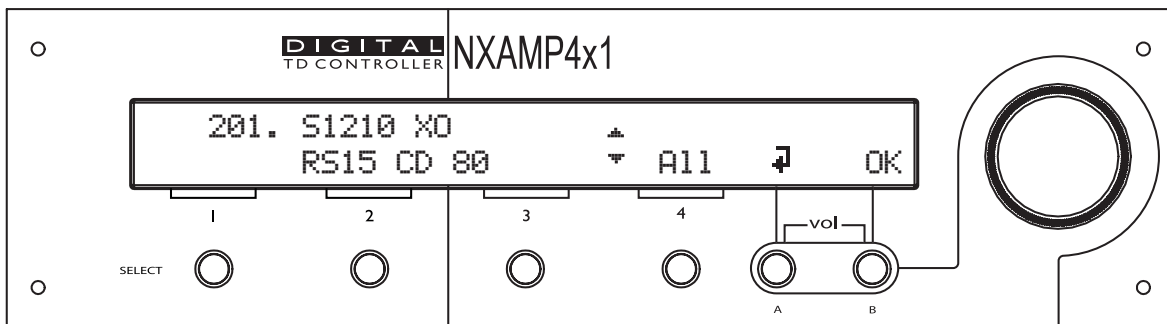

If you press the select 4 button, the previous display (without "All" on screen) will be displayed, but this time all the setup will be available when turning the wheel.

*N.B.: When changing setups inside the same speaker family, the settings of the unit (input patch, delay, gain...) are kept. If you choose another family, settings will go back to the default values.*

### Input Patch

By default and depending on the selected speaker setup selected, some or all of the four inputs will be patched to the outputs. For example, 4 independent channels setups (like 4 x PS15) will use each analog input patched to each output, but 4 way active setups (like Alpha) will use only one analog input patched to all the outputs.

Most of the time, the user can freely change the way inputs are patched to the outputs. However, in some special circumstances, like cardioids setups for example, it is mandatory to have same signal feeding two channels of amplifier or more. In this situation, changing the patch for one channel will automatically affect the other channels.

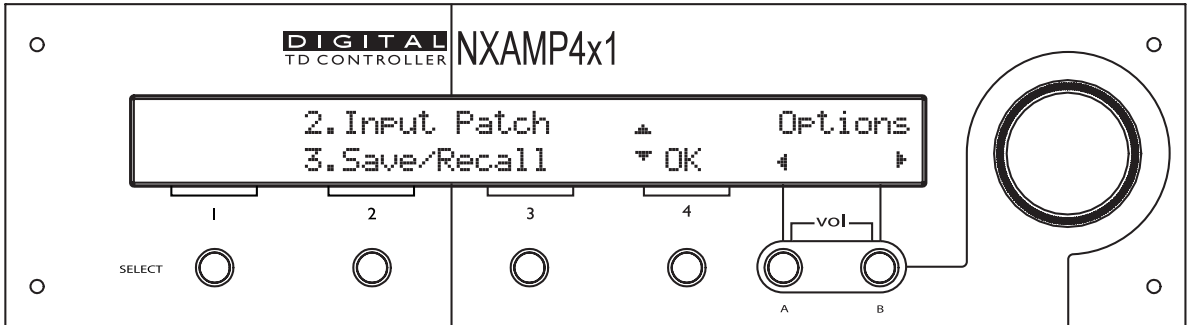

First step to change the input patch is to go to the OPTION menu (see above). Then select the sub-menu "2.Input Patch".

Then the following menu depends if you have a digital input card fitted into the expansion slot of the NXAMP. If not, then the next menu will directly appear. If yes, you will be prompted to select whereas you want to edit the analog input patch or the digital input patch.

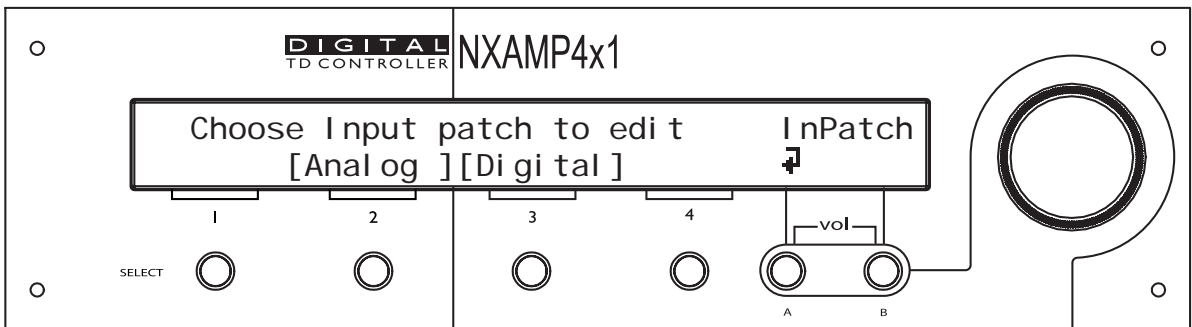

*Note: You can only edit or view one type of input at a time (analog or digital), but both type of input can be mixed for each channel. To do so edit first the analog patch for example and then go to the digital input patch page.*

Once this menu is selected, select the channel you want to change the input patch, by using the corresponding "select" button. Then only the selected channel will be displayed alone on the bellow line of the LCD screen. You can also go back to the previous step by depressing the "A" button.

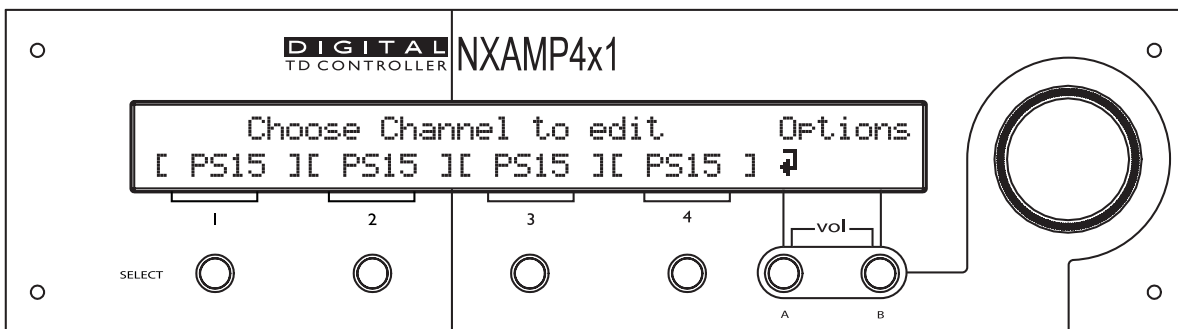

Now that one of the channels is selected, you can see the inputs available on the top line of the screen. Bellow screen is if analog inputs have been selected in the previous menu. On the back of the amplifier, you can see Analog Input A, Analog Input B, and so on. These inputs are named "XLR\_A" (for Analog input on XLR plug A), "XLR\_B" (for Analog input on XLR plug B), "XLR\_C" (for Analog input on XLR plug C) and "XLR\_D" (for Analog input on XLR plug D).

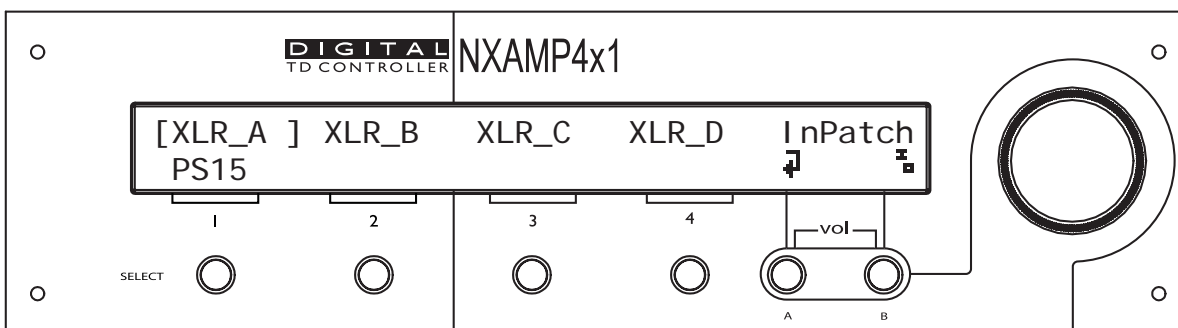

If an optional board is fitted inside the expansion slot, then four Digital inputs will be available too. These digital inputs are named "DIGI\_E" (for Digital Input E), "DIGI\_F" (for Digital Input F), "DIGI\_G" (for Digital Input G) and "DIGI\_H" (for Digital Input H). Bellow is in example of digital patch, if digital inputs have been selected in the previous menu.

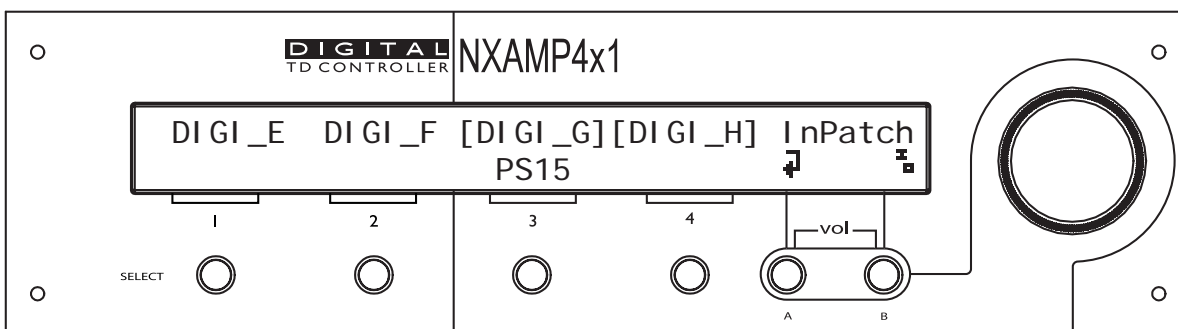

In both cases (analog or digital), if one of the inputs is **between brackets**, it signifies that the **input is currently patched** to the channel displayed on the bottom line of the screen (in the example above, Digital input G (shown as DIGI\_G) plus Digital input H (shown as DIGI\_H) are patched to the PS15 on the channel 3 of the amplifier). In the previous example, with analog inputs, the XLR A used for analog input (shown as XLR\_A) is patched on the PS15 on channel 1 of the amplifier.

**You can toggle the status of the input which is blinking by depressing the "B" button.** If the brackets appear around this input, the patch is ON, if it is clear, then the patch is OFF. You can go from one input to the other by turning the wheel.

*Note: Of course several inputs can be patched to one output. Be careful when patching both analog and digital input together to one channel: It is very unlikely that the two signals can be in phase. We recommend using this solution only for analog backup of digital network, meaning that only digital or analog inputs will be used at a time.*

Once a channel is patched, you can edit the patch for another channel by depressing the "A" button (Back) and selecting another channel, or simply by directly pressing the corresponding "Select" button for another channel (then the name of that channel will appear on the bottom line of the LCD screen, in front of the channel select button).

**Save/recall user setups**

User setups contain all the settings of the NXAMP Powered TDcontroller, so you can consider that a user setup is a snapshot of the amplifier state. To access the Save/recall menu, go to the "OPTION" menu, and select the sub-menu "3. Save/Recall" (see above).

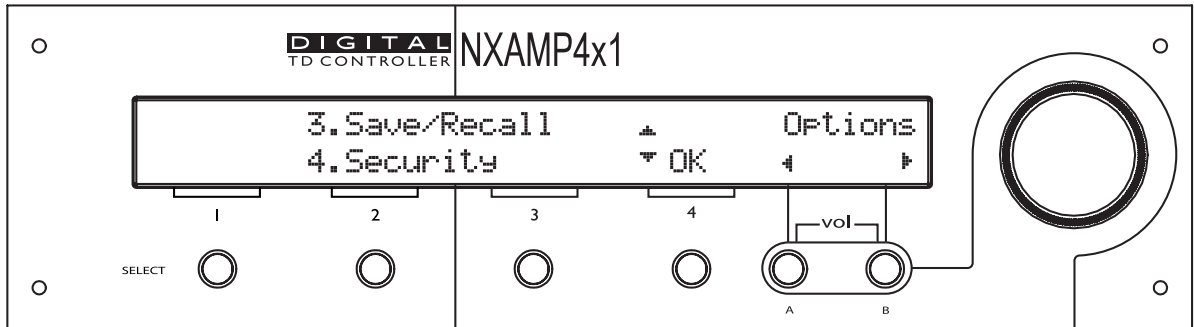

On the center of the screen will be displayed the various setups with the setups name. On each side you can select either "Save" or "Recall" function.

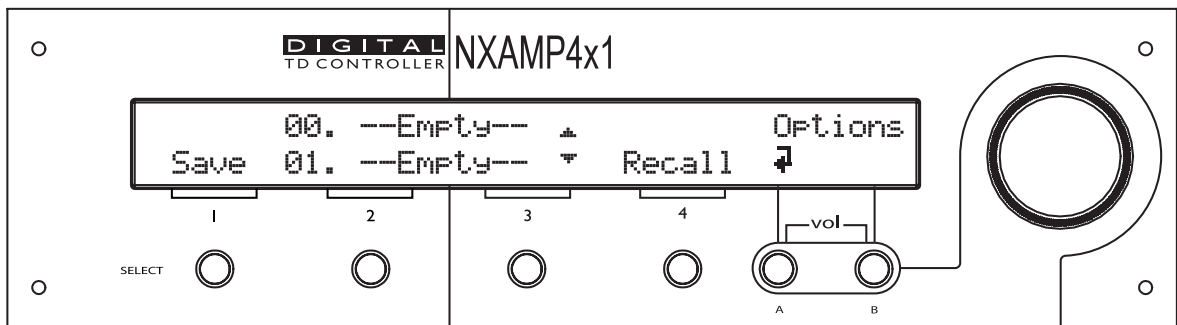

To save a user setup select the memory block you want to use (there are 32 different memory blocks) by turning the wheel till the chosen memory block appears on the top line of the LCD screen. Then press the "Select 1" button (for "Save"). Anytime you can exit this menu by depressing the "A" button (for "Back").



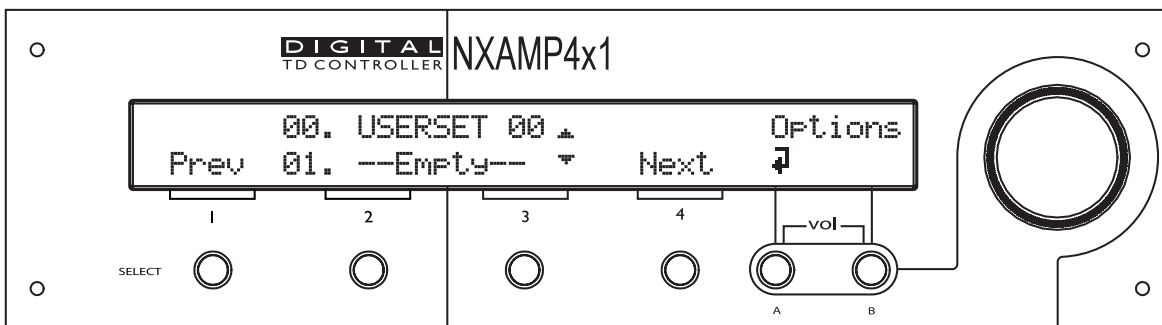

Once the button "Save" has been pressed, you will be requested to enter the name for that user setup (default name is USERSET followed by the setup number). Starting from the first character, turn the wheel to choose a letter, and then depress the "select 4" (for "Next") button to go to the next letter. Depressing button "select 1" (for "Prev") will go back to the previous character. When the last letter has been reached, press the "B" button again to actually save the setup. A confirmation message will be displayed on screen.

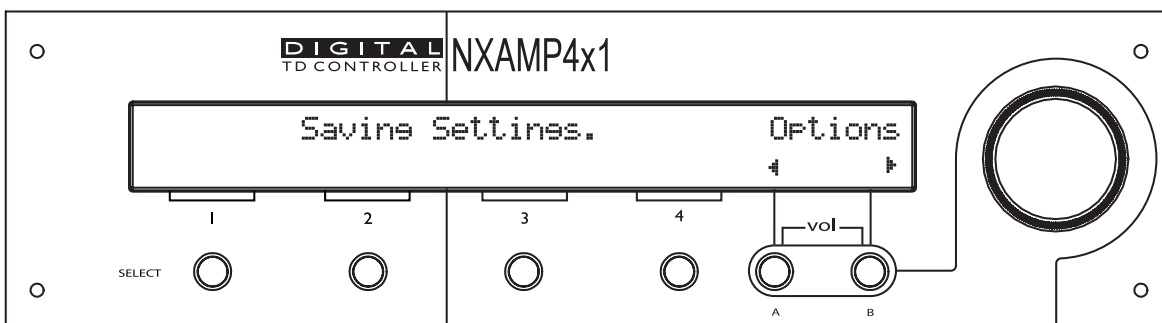

Once the settings are saved, the unit will go back to the default screen, but the scene number will be displayed on top right corner of the LCD screen, as shown on the picture below.

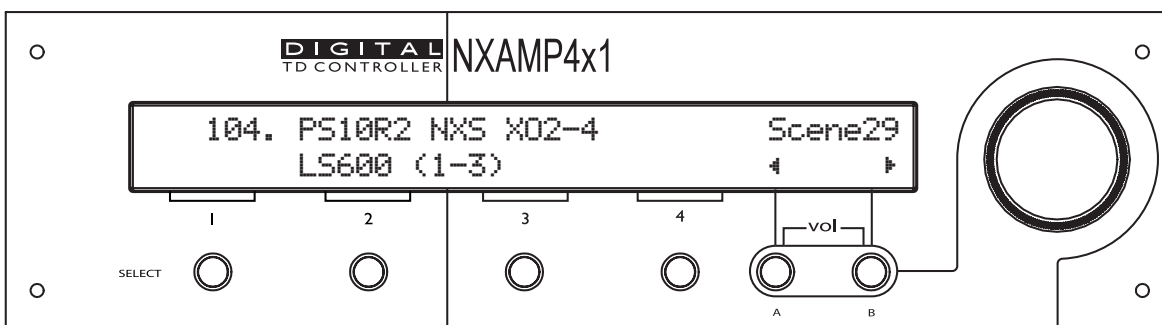

*NB: If settings are manually changed regarding the recalled scene, the scene number will disappear from the default menu. If settings are adjusted back to the saved value of the scene, the scene number will appear again in the default menu.*

To recall a user setup select the memory block you want to use by turning the wheel till the chosen memory block appears on the top line of the LCD screen. Then press the "Select 4" button (for "Recall"). Anytime you can exit this menu by depressing the "A" button (for "Back").

Once the button "Recall" has been pressed, a confirmation step is added. Choose "Yes" to go on with recalling (this is button "Select 4"), or "No" to go back to the previous screen.

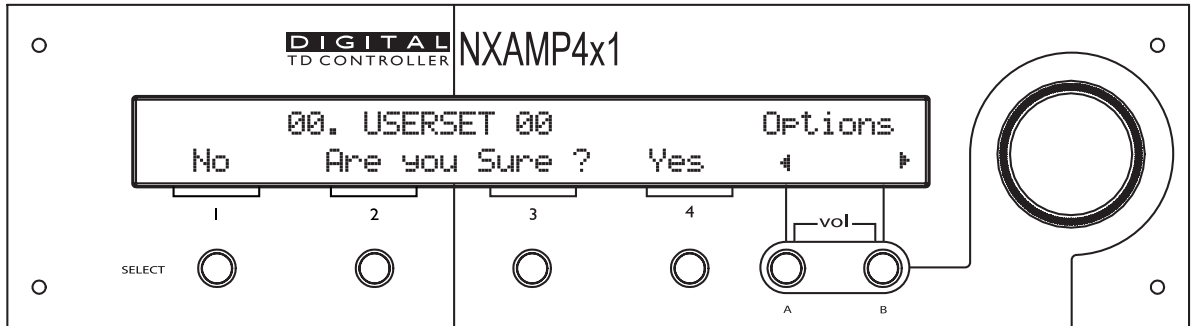

If the selected user setup is recalling a different speaker setup than the one currently in use, another confirmation message will be displayed. Choose "Yes" to go on with recalling (this is button "Select 4"), or "No" to go back to the previous screen.

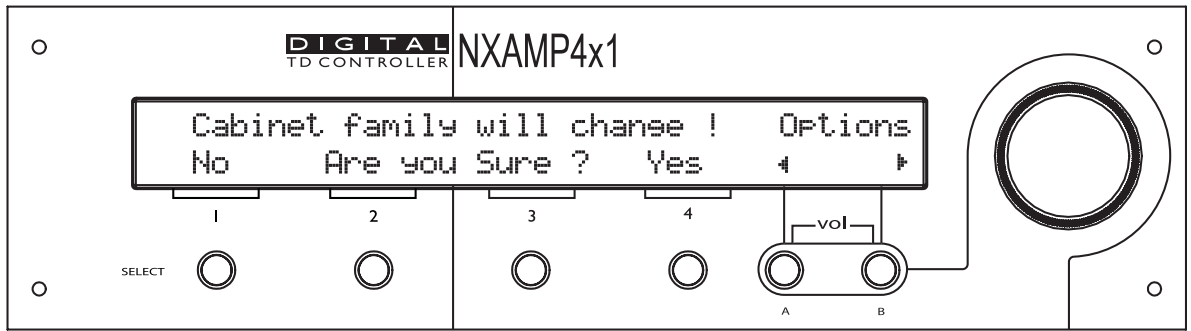

At the end of the recall, the default display is shown on the LCD screen.

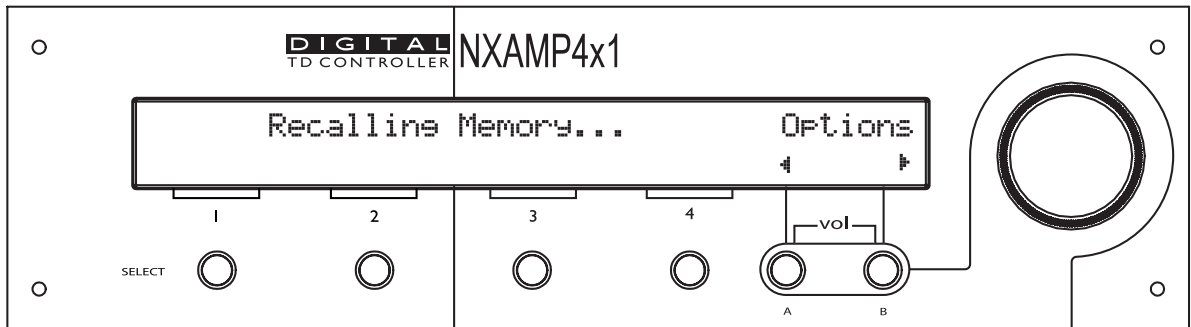

### Security

The menu allows locking the local control or the remote control of the NXAMP.

When the local controls are LOCKED, the user can navigate into the menus but cannot change settings of the unit. However, the MUTE buttons are still working. This feature is enabled through a password that the user can choose (8 letters).

The default password is NEXONEXO.

When the remote controls are LOCKED, the user can monitor the unit but cannot change settings through the network. However, the MUTE buttons are still working. This feature is enabled through the same password.

When this menu is entered, the following display will appear:

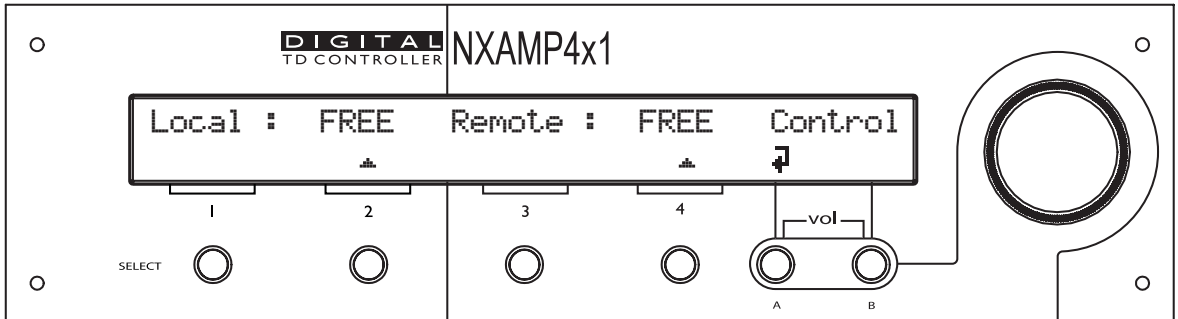

To change either the local or the remote control access, press the corresponding "Select 2" (for local control) or "Select 4" (for remote control) button. If the password has not been entered yet, it will be asked now.

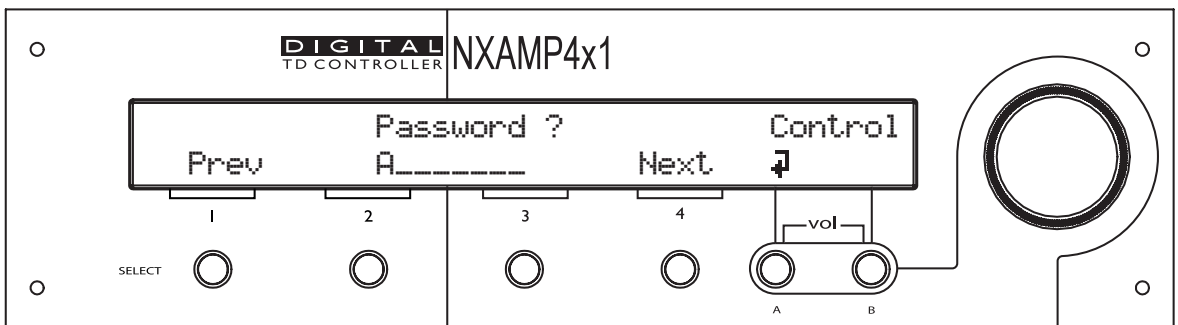

If the wrong password is entered, it will be displayed and you can then only go back to previous menu, which will be still in read-only. If the good password is entered, you then either go back and edit the previous menu (press "Select 4"), or change the current password (press "Select 1"). In this last situation, you will need to enter the new password.

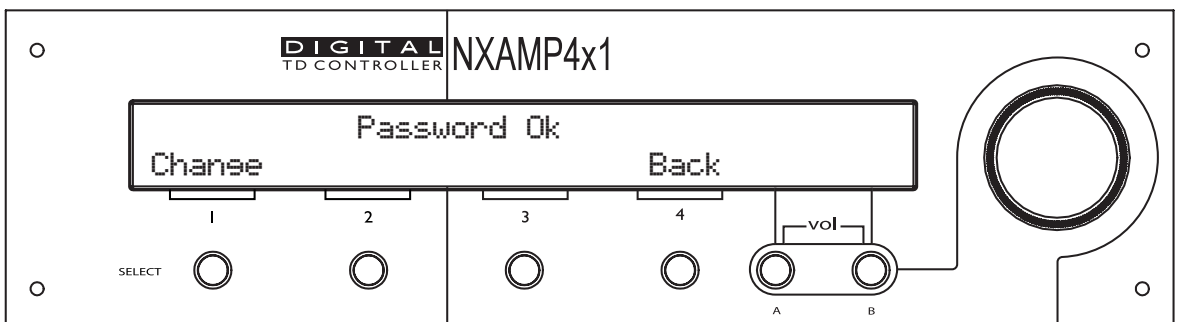

In the previous menu, you can then press the "Select 2" or "Select 4" buttons and toggle the Local or Remote access between FREE or LOCKED. If you leave this menu and come back to this security menu later on, you will need to enter the password again.

## GPIO Mode

This menu allows choosing the way the GPIO are handled by the NXAMP Powered TDcontroller. There are currently 5 modes of GPIO which are described below.

To change the current GPIO mode, press Edit ("Select 4" button) and turn the wheel up or down to the selected GPIO mode. Once done, press OK ("Select 4" button) to validate you choice.

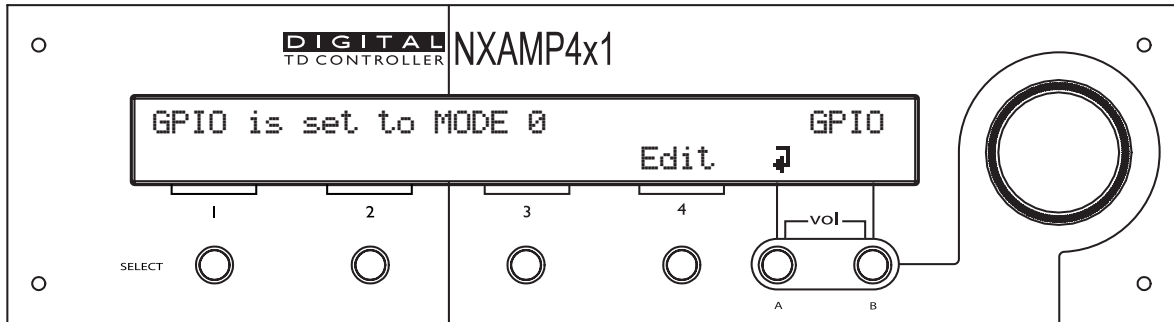

To put a GPI pin in the "High" state, connect it to one of the "+5 Volts" output on the GPIO DB-25 connector. See above in the user manual for proper pin-out. When nothing is connected to a GPI, the state is "LOW" (internal pull-down). A switch can be directly connected to this input, but if a GPIO output of another device should be connected, it is mandatory to ensure a galvanic insulation between the two devices. Only direct connection is authorized between NXAMP when they are located in the same rack.

### GPIO mode 0 (OFF mode)

In this mode the GPIO port is turn off (this is the default mode). All the Outputs are set to 1 (+ 5 Volts), and all the Inputs are unused.

### GPIO mode 1 (Basic remote control mode)

This mode is intended to be used with permanently "High" or "Low" state signals. There is an action depending on the state of each GPI. A state is validated when the state of the pin has changed and is stable for 1 second. Here is the detail:

GPIInput1: Channel 1 Mute/Unmute  
 GPIInput2: Channel 2 Mute/Unmute  
 GPIInput3: Channel 3 Mute/Unmute  
 GPIInput4: Channel 4 Mute/Unmute  
 GPIInput5: ON/Stand-by function

GPOutput1: Channel 1 current out above thrs  
 GPOutput2: Channel 2 current out above thrs  
 GPOutput3: Channel 3 current out above thrs  
 GPOutput4: Channel 4 current out above thrs  
 GPOutput5: Channel 1 Protect/Peak  
 GPOutput6: Channel 2 Protect/Peak  
 GPOutput7: Channel 3 Protect/Peak  
 GPOutput8: Channel 4 Protect/Peak

If GPIInput1 is High, Channel 1 will be muted. If GPIInput1 is Low, Channel 1 will be unmuted. Front Panel mute/Unmute is still working.

If GPIInput2 is High, Channel 2 will be muted. If GPIInput2 is Low, Channel 2 will be unmuted. Front Panel mute/Unmute is still working.

If GPIInput3 is High, Channel 3 will be muted. If GPIInput3 is Low, Channel 3 will be unmuted. Front Panel mute/Unmute is still working.

If GPIInput4 is High, Channel 4 will be muted. If GPIInput4 is Low, Channel 4 will be unmuted. Front Panel mute/Unmute is still working.

If GPIInput5 is High, Amplifier will go to Stand-by mode. If GPIInput5 is Low, Amplifier will go back to running mode.

GPOutput1 to 4 reflects the "Signal" LED on the front panel (meaning current flowing on the output). It will be possible to select a threshold in a next release (a Pilot Tone generator will be implemented also). The GPOutput5 to 8 reflects the "Protect" OR the "Peak" signal for each channel.

#### GPIO mode 2 (Installer mode)

This mode is intended to be used with permanently "High" or "Low" state signals. A state is validated when the state of the pin has changed and is stable for 1 second. There is an action depending on the state of each GPI. Here is the detail:

- GPIInput1: Sequential start-up input pin
- GPIInput2: Analog inputs mute/unmute
- GPIInput3: Digital inputs mute/unmute
- GPIInput4: Change from Setup 1 to Setup 2
- GPIInput5: ON/Stand-by function
- GPOutput1: Sequential start-up output pin
- GPOutput2: Analog inputs mute/unmute output
- GPOutput3: Digital inputs mute/unmute output
- GPOutput4: Change from Setup 1 to Setup 2 out
- GPOutput5: Channel 1 current out above thrs
- GPOutput6: Channel 2 current out above thrs
- GPOutput7: Channel 3 current out above thrs
- GPOutput8: Channel 4 current out above thrs

When starting, if GPIO is set to mode 2, the NXAMP will wait that its GPIInput1 pin goes low to start the amplifier part (big power supplies). Once started, it will put its GPOutput1 pin low also, so several amplifiers can be linked together.

If GPIInput2 is "High", the analog inputs will be muted. If GPIInput2 is "Low", the analog inputs will be unmuted.

If GPIInput3 is "High", the digital inputs will be unmuted. If GPIInput3 is "Low", the digital inputs will be muted.

If GPIInput4 is "High", Saved setup number 2 will be recalled. If GPIInput 4 is "Low", Saved

setup number 1 will be recalled. Warning: Any setup can be recalled, regardless of the loudspeaker family.

If GPIInput5 is High, Amplifier will go to Stand-by mode. If GPIInput5 is Low, Amplifier will go back to running mode.

GPOutput1 has been described above.

GPOutput2 reflects the GPIInput2 (with a small delay and without glitches).

GPOutput3 reflects the GPIInput3 (with a small delay and without glitches).

GPOutput4 reflects the GPIInput4 (with a small delay and without glitches).

GPOutput5 to 8 reflects the "Signal" LED on the front panel (meaning current flowing on the output). It will be possible to select a threshold in a next release (a Pilot Tone generator will be implemented also).

### GPIO mode 3 (CP4SW simple remote mode)

This mode is intended to be used with momentary "High" signals (like push buttons). It is recommended to use the Yamaha CP4SW remote control panel for DME. Connect the button 1 to 4 to the GPI 1 to 4, and each LED to GPO 1 to 4. Here is the detail:

GPIInput1: ON/Stand-by function impulse input  
 GPIInput2: Increase volume impulse input  
 GPIInput3: Mute/unmute (or att) impulse input  
 GPIInput4: Decrease volume impulse input  
 GPIInput5: Mute or attenuator mode selector

GPOutput1: ON/Stand-by status  
 GPOutput2: Max volume reached status  
 GPOutput3: Global mute or attenuator status  
 GPOutput4: Min volume reached status  
 GPOutput5: ON/Stand-by out to other amp  
 GPOutput6: Increase volume out to other amp  
 GPOutput7: Mute/unmute out to other amp  
 GPOutput8: Decrease volume out to other amp

When an impulse of at least 3 seconds is detected on GPIInput1, amplifier will go from ON to Stand-by state or from Stand-by to ON state.

When an impulse is detected on GPIInput2, the volume of all channels is increased by one volume step (see volume menu for steps values).

When an impulse is detected on GPIInput3, all the channels are muted/unmuted. Front panel mute is still working.

When an impulse is detected on GPIInput4, the volume of all channels is decreased by one volume step (see volume menu for steps values).

GPOutput1 is blinking when the amplifier is in stand-by, and ON if the amplifier is running.

GPOutput2 is blinking each time an increase volume command is received, and is ON when volume is set to max.

GPOutput3 is ON when all channels are muted, OFF in other situations.

GPOutput4 is blinking each time a decrease volume command is received, and is ON when volume is set to min.

GPOutput5 reflects the GPIInput1 (with a small delay and without glitches).

GPOutput6 reflects the GPIInput2 (with a small delay and without glitches).

GPOutput7 reflects the GPIInput3 (with a small delay and without glitches).

GPOutput8 reflects the GPIInput4 (with a small delay and without glitches).

### GPIO mode 3 (CP4SW setup switcher mode)

This mode is intended to be used with momentary "High" signals (like push buttons). It is recommended to use the Yamaha CP4SW remote control panel for DME. Connect the button 1 to 4 to the GPI 1 to 4, and each LED to GPO 1 to 4. Here is the detail:

GPIInput1: Select preset 1 impulse input  
 GPIInput2: Select preset 2 impulse input  
 GPIInput3: Select preset 3 impulse input  
 GPIInput4: Select preset 4 impulse input  
 GPIInput5: not used

GPOutput1: Select preset 1 status  
 GPOutput2: Select preset 2 status  
 GPOutput3: Select preset 3 status  
 GPOutput4: Select preset 4 status  
 GPOutput5: Select preset 1 impulse output  
 GPOutput6: Select preset 2 impulse output  
 GPOutput7: Select preset 3 impulse output  
 GPOutput8: Select preset 4 impulse output

When an impulse is detected on GPIInput1, User setup 1 is recalled. Warning: Any setup can be recalled, regardless of the loudspeaker family.

When an impulse is detected on GPIInput2, User setup 2 is recalled. Warning: Any setup can be recalled, regardless of the loudspeaker family.

When an impulse is detected on GPIInput3, User setup 3 is recalled. Warning: Any setup can be recalled, regardless of the loudspeaker family.

When an impulse is detected on GPIInput4, User setup 4 is recalled. Warning: Any setup can be recalled, regardless of the loudspeaker family.

GPOutput1 is ON when setup 1 has been recalled.

GPOutput2 is ON when setup 2 has been recalled.

GPOutput3 is ON when setup 3 has been recalled.

GPOutput4 is ON when setup 4 has been recalled.

GPOutput5 reflects the GPIInput1 (with a small delay and without glitches).

GPOutput6 reflects the GPIInput2 (with a small delay and without glitches).

GPOutput7 reflects the GPIInput3 (with a small delay and without glitches).

GPOutput8 reflects the GPIInput4 (with a small delay and without glitches).

Warning: If a setting is changed on the NXAMP unit (through front panel or remote control), the LED will not turn off, and if the corresponding button is pressed again, the originally saved setup will be recalled.

### **Miscellaneous options**

This menu will allow tweaking different small options available in the NXAMP Powered TDcontroller. This menu is not yet implemented in LOAD2\_52.



## Installation Recommendations

### Audio Chain Recommendations

#### About « Loudspeaker Management Devices »

The NXAMP's factory delay presets are optimised to provide the best possible crossover between the MAIN SYSTEM and SUB systems.

**Optimum results are always obtained for strictly identical signals feeding simultaneously all the NEXO NXAMP Digital TDcontrollers.**

Typically, this signal is delivered by the stereo bus output of a parametric/graphic stereo equalizer, which is fed by the stereo output of the mixing console.

**Inserting devices such as "loudspeaker management controllers" that modify the phase relationship between SUB's NXAMP and MAIN SYSTEM's NXAMP inputs will lead to unpredictable results, and will severely damage the final result. NEXO strongly recommends avoiding use of such devices.**

*N.B.: Do not use NEXO's TDcontrollers (Analog or Digital) to feed the inputs of the NXAMP as this processing is already included inside the NXAMP.*

#### Operating SUB's fed through an Aux Output

If the SUB's are to be operated through a different output than the main system, **NEXO strongly recommends that:**

- The audio chain is strictly identical for SUB's and MAIN SYSTEM's mixing board outputs (same devices with same settings).
- Phase relation between the two feeds is aligned with proper measurement tools (Easera Systune™, Spectralab™ or WinMLS™).

#### Operation of Multiple Powered TDcontrollers

Some MAIN SYSTEM/SUB systems require a minimum of two NXAMP's per side (one for MAIN SYSTEM's, another for the SUB's). Eventually, two or more NXAMP's will operate within the same MAIN SYSTEM cluster. It is mandatory to verify the consistency of the setups and adjustment between processors to avoid the problems described below.

**When using multiple NXAMP's in a single array, all parameters should be identical and set to proper values.**

### System alignment

For a given measurement microphone or listening position, the reference point for this adjustment is the closest point of each array (SUB and Main System) to the given position (see example below)

We recommend that the system is adjusted so that arrivals from MAIN SYSTEM array and SUB speakers are coincident at a fairly distant listening position (typically further than the mixing position).

**Geometrical alignment**

In the example below,  $r_1$  being the smaller distance from MAIN SYSTEM array to listener position, and  $r_2$  being the smaller distance from SUB to listener position, the distance difference is then  $r_1 - r_2$  (specified meters or feet).

- $r_1 > r_2$ , the delay should be set on the SUB **NXAMP** Powered TDcontroller(s).
- $r_1 < r_2$ , the delay should be set on the MAIN SYSTEM **NXAMP** Powered TDcontroller(s)

To convert the result in time delay (specified in seconds), apply:

$$\Delta t = (r_1 - r_2) / C \quad r_1 \text{ and } r_2 \text{ in meters, } C \text{ (sound speed)} \approx 343 \text{ m/S.}$$

The delay parameter is set in MENU "Delay" (See above).

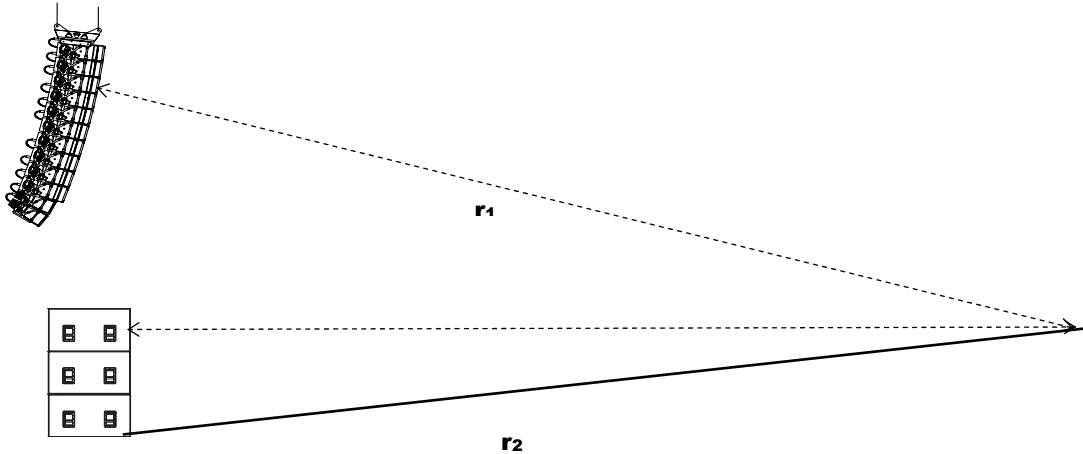

However, it is a safe practice to double-check geometrical alignment with a proper acoustical measurement tool.

**Measuring and aligning phase in the overlapping region**

**Microphone must be set on the ground**, at a fairly distant listening position (typically further than the mixing position).

Phase must be measured with a wrapped display, and measurement must be properly windowed on signal arriving time (same window for SUB and MAIN SYSTEM). When measurement is synchronized to the system-microphone distance, phase can be clearly displayed in the low-frequency range.

## INSTALLATION RECOMMENDATIONS

If the MAIN SYSTEM phase reading appears to be superior to the SUB phase reading, then MAIN SYSTEM will have to be delayed with a value close to the one given by the geometrical alignment.

If SUB appears to be in advance to MAIN SYSTEM, then SUB will have to be delayed with a value close to the one given by the geometrical alignment.

Phase alignment can be considered as correct when phase is coincident over the entire overlapping range (typically an octave from 60 Hz to 120 Hz), and when the overall response is always superior to SUB's and MAIN SYSTEM's individual response.

## NXES104 expansion board and remote control

On the back panel of the NXAMP Powered TDcontroller there is a slot where the user can easily insert an expansion board to add digital inputs and remote control to the unit.

Since July 2009, all NXAMP4x1s and NXAMP4x4s are shipped with an expansion card fitted in, the NX-DFLT card. This card prevents output noises when main AC power feeding NXAMPs is brutally shutdown (ie power down at the end of the show before NXAMPs are switched off). NX-DFLT card should always be fitted in when no other expansion card is used.

Today the only available expansion board is the NXES104, compatible with the Ethersound™ network technology (in its ES100 version). This board offers 4 digital inputs chosen among the 2 x 64 Channels of 24 bits/ 48 KHz audio data of the Ethersound™ frame, and also remote control of the unit through the PC based application ESmonitor™.



**WARNING!** Only 48 KHz Ethersound networks are supported.

### NXES104 Physical description

The NXES104 is designed to fit the NEXO's slot form factor that can be located on the back panel of the NXAMP Powered TDcontrollers.

*NB: This slot features an 80-pins internal connector that is not compatible with the Yamaha mini-YGDAI slot.*

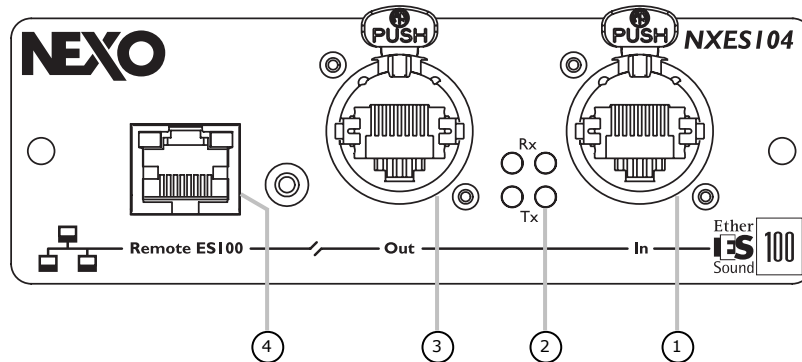

#### (1) Ethersound™ IN Port

This Port features an Ethercon connector. Always use this type of connector to secure your Ethersound™ network from unwanted unplugs. This type of connector also ensures a longer life to the internal RJ-45 contacts, because it preserves it from external traction.

Use this port as an Ethersound™ IN port when connecting to an Ethersound™ network.

**(2) Ethersound™ network Status LEDs**

These four LEDs reflect the status of the Ethersound™ links. The two LEDs next to the IN port shows that data is received from the IN port (when the top one, marked "Rx" blinks) or are send through the IN port (when the bottom one, marked "Tx" blinks).

*NB: When used with mono-directional Ethersound™ network, if no remote control computer is connected, only the Rx LED of the IN port will blink.*

The two LEDs next to the OUT port shows that data is received from the OUT port (when the top one, marked "Rx" blinks) or are send through the OUT port (when the bottom one, marked "Tx" blinks).

*NB: When used with mono-directional Ethersound™ network, if no remote control computer is connected, only the Tx LED of the OUT port will blink.*

**(3) Ethersound™ OUT Port**

This Port features an Ethercon connector. Always use this type of connector to secure your Ethersound™ network from unwanted unplugs. This type of connector also ensures a longer life to the internal RJ-45 contacts, because it preserves it from external traction.

Use this port as an Ethersound™ OUT port when connecting to an Ethersound™ network.

**(4) Remote ES100 port**

The ES100 is an upgrade of the original Ethersound™ standard. It offers new functionalities but can also be downgraded to standard Ethersound™ network for compatibility with older devices. See bellow for details.

This Remote ES100 port is a remote control port only that is only designed to be used with ESmonitor, the remote control software for Ethersound™ network. Connect the PC computer running ESmonitor to this port.



**WARNING!** Do not use this port if your NXAMP Powered TDcontroller is used in an Ethersound network with some non ES-100 devices (see bellow for details).

On top of this RJ-45 plug you will find 2 LEDS: The left one is for "Link", meaning that equipment is well connected to the plug, the right one is for "Activity" meaning that some Ethernet frames are received on the port.

**Various Ethersound™ devices description**

Here is a short reminder about various Ethersound™ devices.

### **Mono-directional, non ES100 devices**

Simplest Ethersound™ devices are mono-directional, non ES100: These devices features two ports (ES IN and ES OUT) and can be only connected to mono-directional networks (64 channels of 24bits/48 KHz). Do not use them in a bidirectional part of an Ethersound network or in a network where ES100 functions are used.

### **Bi-directional, non ES100 devices**

More sophisticated Ethersound™ devices are bi-directional, non ES100. These devices features two ports (ES IN and ES OUT) and can be connected to both mono and bi-directional networks (2 x 64 channels of 24 bits/48 KHz). Do not use them in a network where ES100 functions are used.

*NB: The NEXO NX242-ES4 Digital TDcontroller is a bi-directional, non ES100 devices.*

### **ES100 devices**

These devices compatible with the ES100 variant of the Ethersound™ network are bi-directional devices (compatible with both mono and bi-directional networks) that offer new functionalities (we called them the ES100 functions). Here is a list of the new ES100 functions:

- **Device to device communication:** With classical Ethersound implementation, only the remote control computer can communicate with the various devices or the network, and only audio data can be exchanged between devices. With ES100, devices can send non-audio data between them without passing through the remote control computer.
- **Ring topology:** Instead of the classical daisy-chain Ethersound™ network, you can now connect the last OUT port of the network to the IN port of the primary master, that has to be defined as the *Preferred Primary Master* through ESmonitor (every other device should be set as a loop back device). See ESmonitor User Manual included with this software for details. Thus one of the network cables can fail without any lost on the network integrity. To control the network, at least one of the ES100 devices inside the network should have a "Remote ES100 port" (see below).
- **3<sup>rd</sup> communication port:** Optionally, a 3<sup>rd</sup> Ethernet port can be added on the ES100 device (this is the "Remote ES100 port" that you can find on the NXES104). From this port you can take control over the connected device, but also over the whole Ethersound™ network. To do so, connect a computer running the ESmonitor software, just like you were connecting to the IN port of the Primary Master device of the network.

*N.B.: You can easily recognize the ES100 devices thanks to this logo*



### **ES100/spkr devices**

The ES100/spkr implementation is a light implementation of the ES100 above: ES100/spkr is compatible only with mono-directional Ethersound™ network, and can only extract a maximum of four outputs.

## Ethernet Additional hardware

### Hubs

A hub (also known as repeater) is a central connection point for computers on a star-topology-based network. Any data it receives is broadcasted to all ports, and then only the computer that is 'listening' for the data actually receives and processes the transmission. Hubs are the 'unintelligent' relatives of switches.



**WARNING!** Due to their internal architecture, repeater hubs **MUST NOT** be used in Ethersound™ networks.

### Switches

There are different types of switches, using different protocols that interact with other protocols to provide all the necessary transmission services. The outline for implementing protocols in altogether seven layers is defined in a worldwide ISO standard called OSI (Open System Interconnection)

#### Layer 2, 3 or 4 switches

Layer 2 is the communication protocol that contains the physical address of a network device. It is called the "data link layer" or "MAC (=Media Access Control) layer" and contains the address inspected by a bridge or switch. Layer 2 processing is faster than layer 3 processing, because less analysis of the frame is required. As the EtherSound protocol contains exclusively layer 2 information, switches other than layer two must not be used.



**WARNING!** Layer 3 and Layer 4 switches are not compatible with the Ethersound™ networks. Only Layer 2 switches can be used.

These layer 2 switches can be either managed or unmanaged. Managed switches are necessary to set up VLAN networks so that EtherSound can co-exist on a larger network with other applications. Some switches provide functionalities of the so-called SPANNING TREE PROTOCOL for inter-switch communication and network management. The EtherSound protocol is **NOT COMPATIBLE** with the Spanning Tree Protocol (should be disabled on manageable switches).

### Wireless LAN

A local area network that transmits over the air typically (but not exclusively) in an unlicensed frequency or, among others, infrared line of sight. Wireless access points (base stations) are connected to an Ethernet hub or server and transmit a radio frequency that can penetrate walls and other non-metal barriers. Roaming users can be handed off from one access point to another like, for example, in a cellular phone system. Wireless LANs are not suitable for EtherSound networks due to significant bandwidth limitations.

## Ethernet cables

Cables used within the EtherSound network are straight cables. The cable used to connect directly the remote control PC to the Primary Master or to any of the "Remote ES100 port" is a crossover cable.

The following paragraphs describe the main twisted pair cable types used. Among them, you will find descriptions of cables listed for reasons of completeness, but that are not suited for EtherSound networks.

### CAT5, 5e, 6, 7 cables

Level 5 cable supports transmission rates of up to 100Mbps (200Mbps in full-duplex), CAT5e, even 1Gbps - is the most common today. Category 6 supports up to 10Gbps, for CAT6 and CAT7 new standards are under development.

### Horizontal (solid) cable and patch (stranded) cable

Both UTP (Unshielded Twisted Pair) and STP (Shielded Twisted Pair) come in stranded and solid wire varieties. The stranded wire is the most common and is also very flexible for bending around corners. Solid wire cable has less attenuation and can span longer distances, but is less flexible than stranded wire and cannot be repeatedly bent (and therefore not suitable for live applications). Following are the twisted pair categories.

Horizontal cable (also called solid cable) is made of plain copper conductors and has a low characteristics shift with aging. It must be used for long runs of steady cabling (typically the cables inside walls and ceiling).

Patch cable (also called stranded cable), more flexible, is made of stranded copper conductors and has larger losses and characteristics shifts than horizontal cable. It can be used for versatile termination between wall outlet and device, or between devices. These cables are explicitly labeled "PATCH". The TIA/EIA 568A wiring standard allows the use of horizontal cable up to 90m (295ft) lengths with a maximum amount of 10m of patch cable for both ends added together.

### UTP, FTP (ScTP), STP, SFTP cables

UTP stands for Unshielded Twisted Pair. It is a cable type with one or more pairs of twisted insulated copper conductors contained in a single sheath. It is the most common type of cabling used in desktop communications applications.



**WARNING!** For optimum performance sake and electromagnetism behavior, the UTP cables shall NOT be used.

FTP stands for Overall Foil Shielded Twisted Pair (ScTP for Screened Twisted Pair): Cable is wrapped with an aluminized plastic foil). That kind of cabling is not recommended for applications where the cable is repeatedly bent. The foil tends to break leading to severe loss of performance over the distance.





**WARNING!** Do not use FTP cabling for live application.

STP stands for Shielded Twisted Pair: Screen is made of copper braid. SFTP stands for Overall Braid + Foil Shielded Twisted Pair: Foil screen and braid shield. For all these cables, transmission characteristics are the same. The difference is the behavior with respect to electromagnetic interference. We recommend cabling that has a superior quality sleeve in order to protect the cable. Ideally this sleeve should halogen free in order to comply for the installation standards.

Bellow is some various cables that have been seriously tested by Auvitran (see [www.auvitran.com](http://www.auvitran.com) for more information).

Manufacturer	Cable Reference	TYPE	Max. length without Error	Max length for reliability	Specific comments on tested cables
<a href="#">BELDEN</a>	7860E	FTP	130 m	110 m	Ruggedized Cat6 Cable, Shielded, AWG24 difficult to fit in standard RJ45 "male" plugs (Blue)
<a href="#">BELDEN</a>	1875GB	UTP	120 m	100 m	Flat smooth ruggedized Cat6 Cable, no shield (White)
<a href="#">CAEGROUPE</a>	AudioLan	FTP	85 m	75 m	Really smooth ruggedized cat5e, Look like a mic Cable, a little bit hard to mount on RJ45 at the beginning (Black)
<a href="#">CAEGROUPE</a>	AX CA23653	S-FTP	140m	120 m	Ruggedized Cat5e cable, really good for exteriors, SFTP+One shield fold per pair (Green)
<a href="#">CAEGROUPE</a>	Giga-Audio	S-FTP	140m	120 m	Ruggedized Cat5e cable, very good live cable, SFTP+One shield fold per pair (Black)
<a href="#">DRAKA</a>	799090	S-FTP	140 m	120 m	Really Ruggedized Cat5e cable, Does not fit in standard RJ45 "male" plugs (0.22m <sup>2</sup> ), SFTP+One fold per pair (Black)
<a href="#">DRAKA</a>	CT2672600	FTP	100 m	90 m	Ruggedized Cat5e cable (Black)
<a href="#">Harting</a>	IP20 System cables 4-pole	S-TP	100 m	100 m	Industrial Ethernet stranded cable.
<a href="#">KLOTZ</a>	RC5 RAMCATS 100 ohms	S-TP	70 m	65 m	STP stranded AWG26
<a href="#">KLOTZ</a>	RC5 SU	U/UTP	100 m	90 m	AWG24/1
<a href="#">LINK</a>	Eurocable Extraflex Cat5	UTP	85 m	75 m	Very smooth Ruggedized Cat5, Without any shield so be careful with EMC problem (Black)
<a href="#">LINK</a>	Eurocable Extraflex Cat5	S-FTP	123 m	105 m	Ruggedized Cat5 cable, very good live cable (Black)
<a href="#">Neutrik</a>	ZNK CT2672601	S/FTP	90 m	80 m	Cat5E Cable, Shielded
<a href="#">Proplex</a>	PCCAT5EP	-	97 m	85 m	Cat5E Cable, Shielded
<a href="#">Proplex</a>	PCCAT5EPUTPP	UTP	88 m	80 m	Cat5E Cable, No shield

## Fiber Optic

Fiber Optic is similar to twisted pair but does not conduct electricity. It is used in situations where a network may suffer from environmental conditions (e.g. lightning), such as in LAN connections between buildings. Fiber optic is also very valuable where electronic emissions or electro-magnetic interferences may have an impact on the network, e.g. on particular factory floors. Furthermore, fiber optic cables and Ethernet standard allow for segments up to two km(1.24mi) long (cf. thin coaxial • 185m(607ft), UTP • 100m(328ft)) and thus permit to connect remote nodes and buildings that otherwise would not be accessible.

To use Fiber Optic cable in EtherSound networks, Media Converters or dedicated Ethersound™ devices such as AVAVRed-ES100/FoNeutrik (EtherSound Redundant link with 2 multimode optical OptiCon Neutrik connectors) must be used.

## Installation inside the NXAMP

To install the NXES104 card inside an NXAMP Powered TDcontroller, first remove the two screws on each side of the NX-DLFT card on the rear of the amplifier. Keep these screws as they will be used with the NXES104 card. Use a small screwdriver to slightly separate the card from the NXAMP chassis, and remove it.

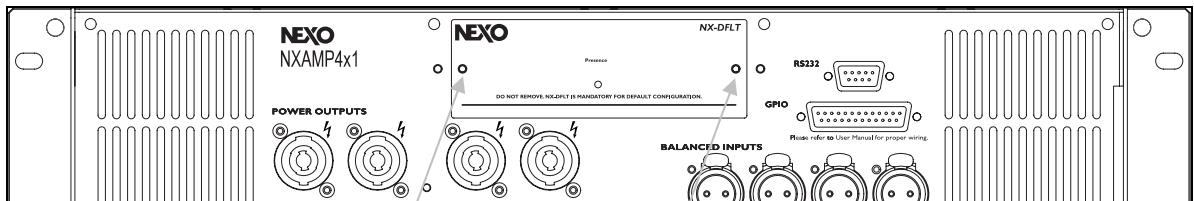

Slide the NXES104 board inside the rails, and push it firmly inside the NXAMP. Then put the two screws back to fix the NXES104 on the rear panel of the NXAMP.

*N.B.: Keep the NX-DLFT card in a safe place as you would need to put it back if you decide to remove the NXES104 board for some reason. Do not use the NXAMP Powered TDcontroller without any expansion board fitted.*

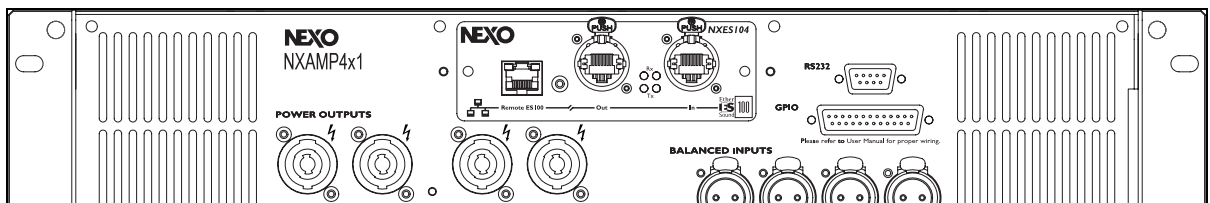

## NXAMP control page in ESmonitor software

ESmonitor software by Auvitran is a free PC based application running under Windows XP and Windows Vista, permitting full control over an Ethersound™ network. From this software you have access to the routing of the network and to some specific control depending on the device connected.

NEXO provides in each revision of the NXAMP firmware the last version of the ESmonitor software that has been successfully tested with this firmware. It is recommended to use this specific version of the ESmonitor software.

Please refer to the ESmonitor User Manual provided by Auvitrans as a pdf file when installing the ESmonitor application on your computer. Once your Ethersound™ network is completed, you can access to the control page of the NXAMP Powered TDcontroller.

**Compatibility issues**

The table below sum up the remote control possibilities with various version of NXAMP firmware and ESmonitor software so far.

ESmonitor Software Revision NXAMP firmware revision	Esmonitor before v3.5	Esmonitor v3.5 to v3.7	Esmonitor v3.8 to v3.9.3 (*)
LOAD2_46 to LOAD2_51	No control	Limited control	Limited control
LOAD2_52	No control	Limited control, buggy vue-meters.	Full control

**Graphical user interface**

If you are using the latest version of ESmonitor (v3.8 or above) with NXAMP using LOAD previous LOAD2\_52, only the limited control page shown below will appear :

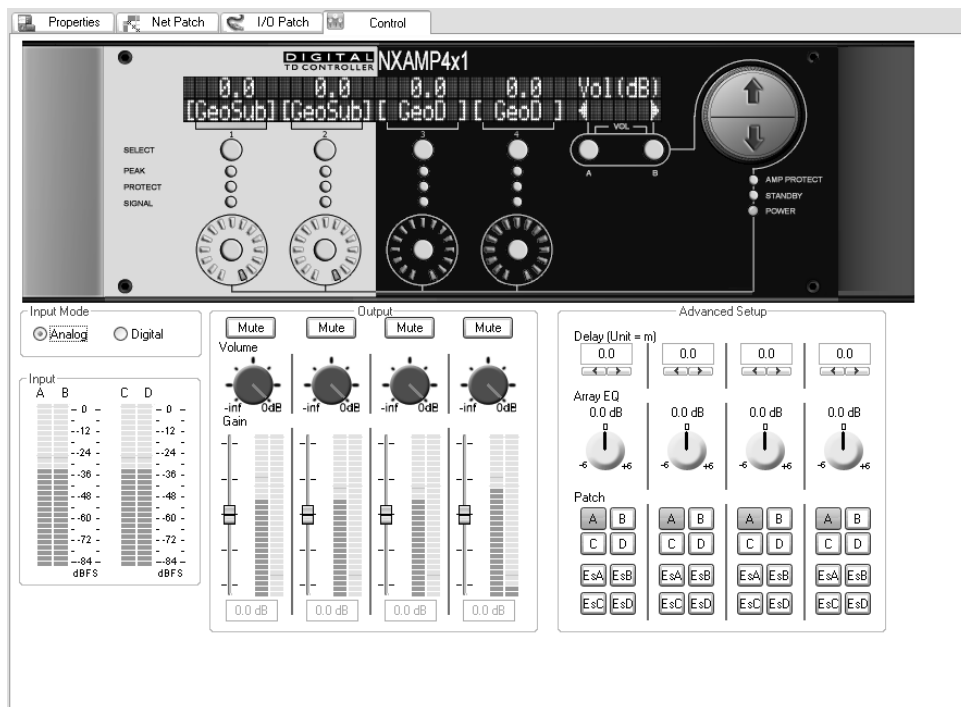

Here is now the full control page when using ESmonitor v3.8 or above and LOAD2\_52.

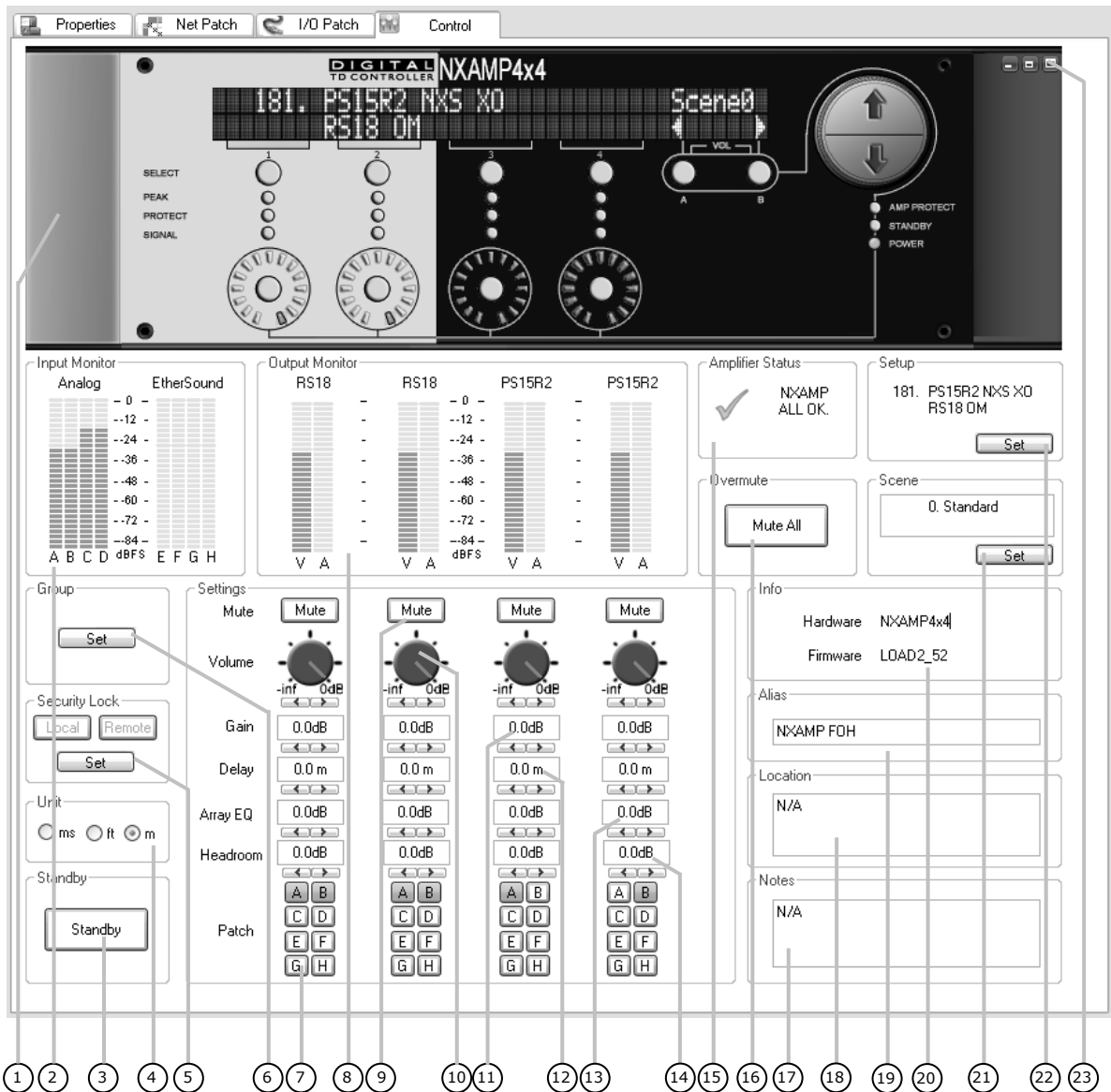

**(1) Virtual front panel**

This virtual front panel is a copy of the NXAMP user interface. You can see the LCD display and the front panel LEDs status. You can use all the push buttons and the encoder wheel by clicking with your mouse or using its wheel.

**(2) Input meters**

Here you can see the input meters of the NXAMP. The channels A, B, C and D are the four analog inputs of the unit (on XLR at the back) and the channels E, F, G and H are the four Ethersound input of the unit (through the NXES104 fitted into the expansion slot).

*N.B.: Use one of the previous tabs (Net Patch or I/O patch) to select which Ethersound™ channel will be routed to the NXAMP E, F, G or H digital inputs. See the ESmonitor user manual for details.*

### (3) Standby button

Pressing this button will put the NXAMP in standby mode: the large power supplies used by the power amplifiers are turned off, and the controller is put in a low power mode.

Once in standby, the control page of the NXAMP in ESmonitor will become gray and all the controls are non working.

To resume from standby mode, you can either press the standby button again in ESmonitor, or press the "B" button on the front panel for at least 5 seconds (till the load revision appears again on the LCD screen).

### (4) Delay Unit

Here you can choose the delay unit between millisecond, meters or feet by depressing the corresponding radio button.

### (5) Security Lock

This button allows locking the "Local" (hardware interface on the front panel) or the "Remote" (through the ESmonitor) buttons to prevent changing the settings on the NXAMP. Both controls can be locked at the same time. Locking/unlocking can be set/unset through ESmonitor or through the NXAMP front panel.

### (6) Group

If you want to group several NXAMP into the same group, in order to apply same setting to several unit use the "Set" button to add the current NXAMP to the group you wish.

- If no group exists so far, you will be prompt to enter a group name.

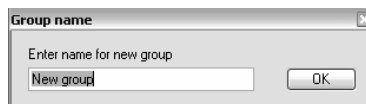

- If a group already exists, you will be redirected to the "Properties" page of the NXAMP where you will be able to select a group.



Select the group you wish to put the NXAMP in. You can group NXAMP4x1 and NXAMP4x4 into the same group. One NXAMP can be part of several groups (for example you can do a group with all units, and some smaller ones for specific applications).

The remote control page of the group can be accessed if you press the "Group" tab in the left view of ESmonitor. If you select a non empty group, you will be able to access the remote control page of the group, like shown bellow:

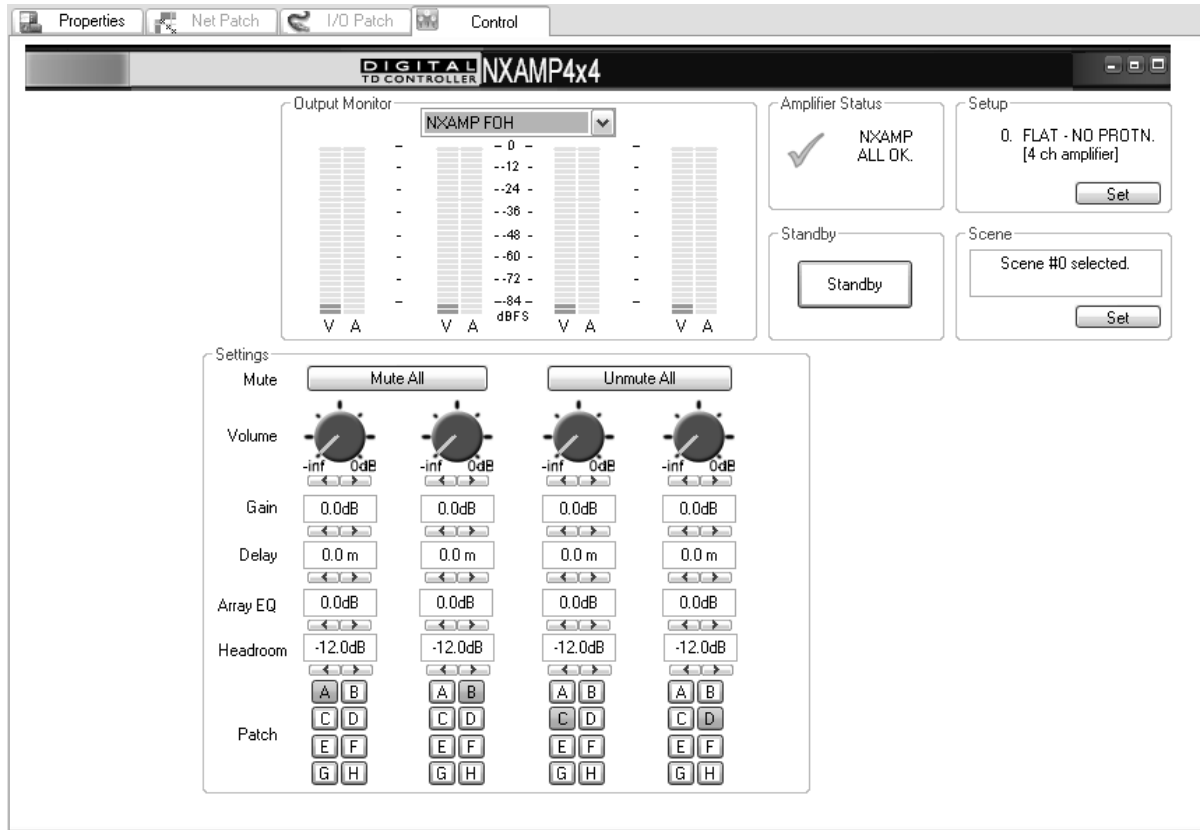

Note that only some settings are accessible to the user, if then the user interface is the same than for an individual NXAMP. On top of the output meters you can choose the NXAMP of the group you wish to monitor the output meters.

If some settings are different between two units inside the same group, the corresponding control will be displayed in RED. Once a control is changed in the group control page, the settings will be applied to all units in the group.

**(7) Input Patch**

For each channel, you can see eight buttons corresponding to the eight available inputs (4 analog, from A to D, and 4 digital, from E to H). Click on the button to patch or unpatch an input. If the button is dark, it means that the input is patched, if not it is white.

*N.B.: On some setups the input patch may be linked.*

**(8) Output meters**

For each channel there are two output meters; the left one is showing the output voltage (V), whether the right one is showing the output current (A).

**(9) Mute button**

Click on this button to mute or unmute individually a channel.

**(10) Volume control**

This button can set up the volume for each channel of the NXAMP. To adjust the volume with this virtual pot, you can click and drag the button itself or use the mouse wheel while you are on the virtual pot area or use the two small arrows bellow the virtual pot.

*N.B.: On some setups the volume settings may be linked.*

**(11) Gain control**

To adjust the gain on one channel, use the two small arrows bellow the value display. You can also simply goes onto this control and use the mouse wheel.

*N.B.: On some setups the volume settings may be linked.*

**(12) Delay settings**

Use the small buttons bellow the text box to increase or decrease the delay settings for each channel.

*N.B.: On some setups the delay settings may be linked.*

**(13) ArrayEQ settings**

To adjust the ArrayEQ on one channel, use the small arrows bellow the text box. You can also simply go to this control by utilizing the mouse wheel.

*N.B.: On some setups the ArrayEQ settings may be linked.*

**(14) Headroom settings**

By using the small arrows bellow the text box the Headroom value for one channel can be adjusted. You can also simply go to this control by utilizing the mouse wheel.

*N.B.: On some setups the Headroom settings may be linked.*

**(15) Amplifier Status**

This control displays the current status of the Amplifier. If all parameters are OK (like temperature, DC offset, mains value, etc...) the display will be "NXAMP ALL OK". If not, the

error will be displayed here. If the unit is in standby, it will be also shown here.

**(16) Overmute**

The "Mute all" button acts as an "Overmute" button: When pressed, the four channels of the unit will be muted, but the individual mute status of each channel is preserved. That is why the "Mute all" button is called "Overmute"; it is just like a second layer of muting, as you can see in the picture below.

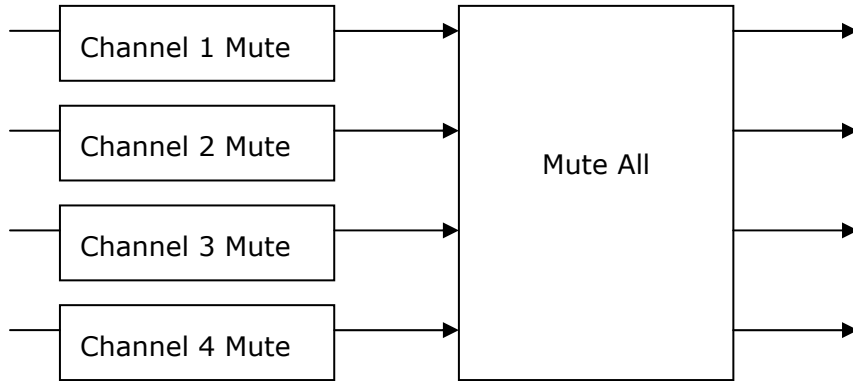

If you are in the following situation: Some channels are individually muted and the Mute all is ON, like on the picture below (gray channels are muted):

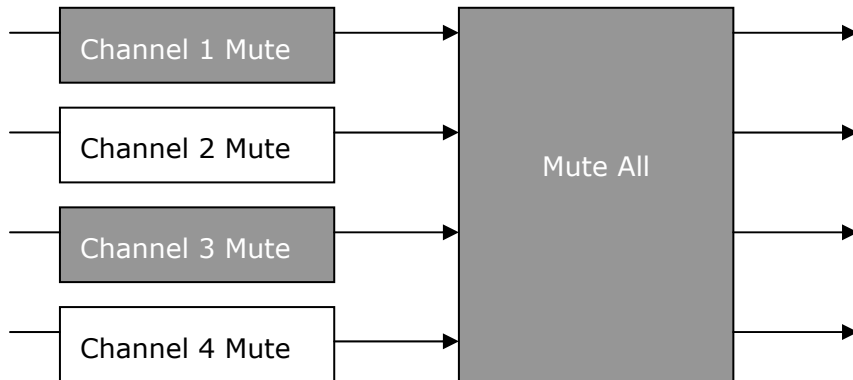

Now, if you press the "Channel 2 Mute" on the amplifier front panel or into ESmonitor, the "Mute all" function will be *copy back* to the individual channel mute, except for the Channel 2 that you have just pressed:

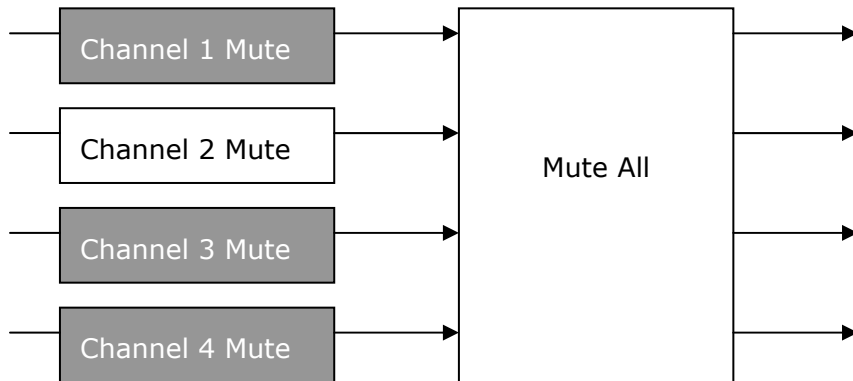



**(17) Notes**

In this textbox you can take some notes of your choice. The text is saved on the computer, not on the NXAMP itself.

**(18) Location**

This textbox is foreseen to enter the physical location of the unit. The text is saved on the computer not on the NXAMP itself.

**(19) Alias**

This is the alias of the NXAMP used to display the unit in the network list, tree or group on the left of ESmonitor. By default the NXAMP will have an alias like this "NXAMP-XXXXXX", where the last six characters is the end of the MAC address of the NXES104 board fitted into the NXAMP.

The Alias is stored on the computer. It uses the MAC address of the NXES104 to identify a specific unit. Changing the computer or the NXES104 will disturb the alias of the units.

**(20) Hardware and Firmware**

Here you check whereas the connected unit is an NXAMP4x1 or an NXAMP4x4 and what is the firmware revision inside.

**(21) Scene**

Saving or recalling a scene can be done here pressing the Set button.

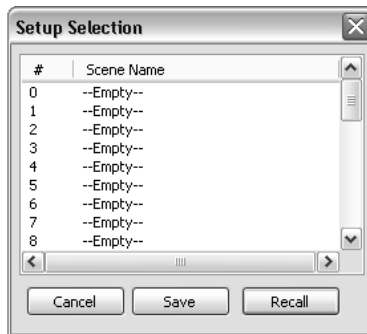

Select the Scene of your choice and then choose Save or Recall. The scene and there name are saved into the NXAMP itself.

*Warning: Switching from a scene to another one is immediate and does not ask for any confirmation, even if the cabinet family is changed. Therefore take care when changing scene under live conditions.*

**(22) Cabinet Setup**

Pressing the "Set" button in this control displays the list of the setups available into the memory of the NXAMP. By default only the setup from the same family are displayed.

*NB: First time you press the "Set" button for a NXAMP firmware that is not known yet by ESmonitor on this computer, it might take a few seconds to read all the setups available. Then, the setups name and number are stored on the computer itself, so next time no need to wait.*

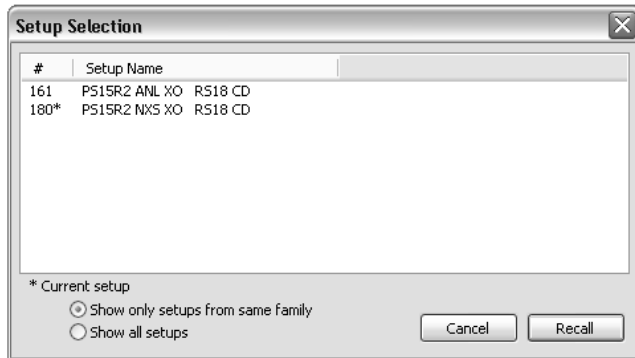

The current setup is marked with a star. You can also see the setup number if the left column. If you go to "Show all setups" mode by pressing the radio button, then all the setups available in the units will be displayed.

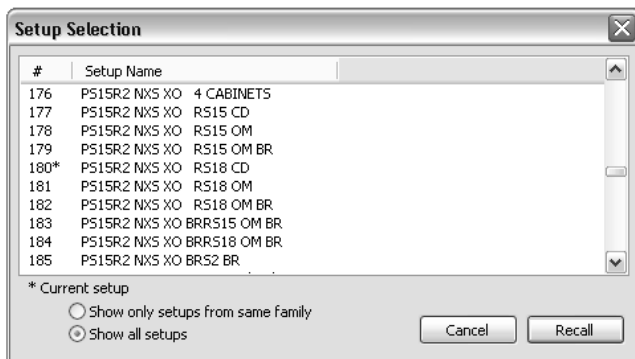

If you recall a setup from a different family, a confirmation window will appear to prevent any mistake. A key combination on the computer keyboard will be then required to confirm the selection.

**(23) Virtual front panel size**

In order to fit on smaller computer screen, you have the possibility to reduce the size of the virtual front panel to be able to display all the control of the unit on screen. There are three sizes available: Maximized (the whole virtual front panel is displayed), intermediate (only the virtual LCD display is visible) and minimized (only the part above the LCD is displayed).

## NXwin4 software for NXAMP firmware upgrade

Please check regularly on NEXO website ([www.nexo-sa.com](http://www.nexo-sa.com)) for NXAMP Powered TDcontroller firmware upgrade. These upgrades are freely downloadable and can improve:

- NEXO’s setup for cabinets (including new setups for new products).
- NXAMP firmware functions.
- NXAMP remote control functions.



**WARNING!** NXAMP Powered TDcontroller is delivered with a FLAT firmware only (no NEXO setup installed), so it is mandatory to upgrade the firmware of the unit to the last available firmware that you will find on our website.

### What you need to upgrade your NXAMP

NXAMP can be upgraded either:

- By its serial port (RS-232).
- By its “Ethersound™ IN” or “Remote ES100” port if a NXES104 board is fitted.

*NB: Upgrade through one of the above Ethersound™ ports when the unit is a Primary Master. This provides much faster results than the other solution.*

### Serial port upgrade

To upgrade from the serial port you will need:

- A computer running Windows XP with NXwin4 installed
- A serial port or an USB to serial adapter
- A null-modem cable (“crossover” serial port cable, with 2 DB9 female plugs). See cabling bellow.

NEXO RS232 serial port		PC COM port
2 RXD	←-----Receive-----	3
3 TXD	-----Transmit-----→	2
5 GND	<b>Signal ground</b>	5
Other	Unused	Other

## Ethersound™ upgrade

To upgrade from the Ethersound™ port you will need:

- A computer running Windows XP with NXwin4 installed
- A RJ-45 Ethernet 100 base TX full duplex port
- A crossover cat5 network cable.

### Connect the computer to the NXAMP

Locate the serial port or the one of the usable Ethersound™ port at the back of the controller, and use the null-modem cable or the crossover cable to connect the computer.

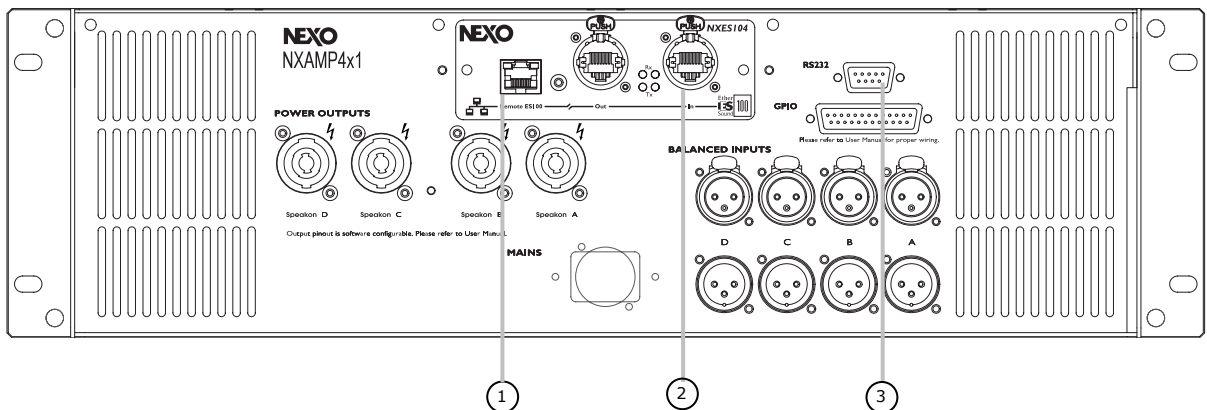

#### (1) Remote ES100 port

This port can be used to upgrade the NXAMP when a NXES104 board is fitted. Be sure that no non-ES100 devices are connected to the other Ethersound™ ports of the NXAMP.

#### (2) Ethersound™ IN port

This port can be used to upgrade the NXAMP when a NXES104 board is fitted. You can either directly connect the computer to this port or reach the NXAMP through the Ethersound™ network. If several NXAMP are connected together in an Ethersound™ network, you can upgrade automatically one after the other.

#### (3) RS-232 Serial port

This port can be used with or without NXES104 board fitted inside the amplifier. However, we recommend using one of the previous Ethersound™ ports if an NXES104 board is fitted because NXwin4 can also upgrade the firmware of the Ethersound™ board itself (what cannot be done through the serial port).

### Using the NXwin4 software

Use the Nxwin4\_setup.exe to install the software on a Windows XP based computer. If you are already using ESmonitor you don't need to upgrade the Ethersound API.

*NB: Even if you plan to use the serial port for upgrade, your computer must have an Ethernet port for the software to set up correctly.*

Then through the start menu, double-click on Programs> Nexo> Firmware Update> NXwin4. The Nexo loader will appear on the screen of the computer. Use the "Browse" button to select the firmware file (the extension is .dld).



Then choose the serial port connected to the NXAMP Powered TDcontroller (note: only the detected and available serial port appears in the list), and finally press the download button. The following splash window should pop up on screen:

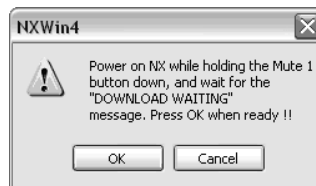

To upgrade the NXAMP (fitted with NXES104 board) through the Ethersound network, choose the Ethersound port interface and select the network card connected to the Ethersound network. Select device that you want to upgrade.

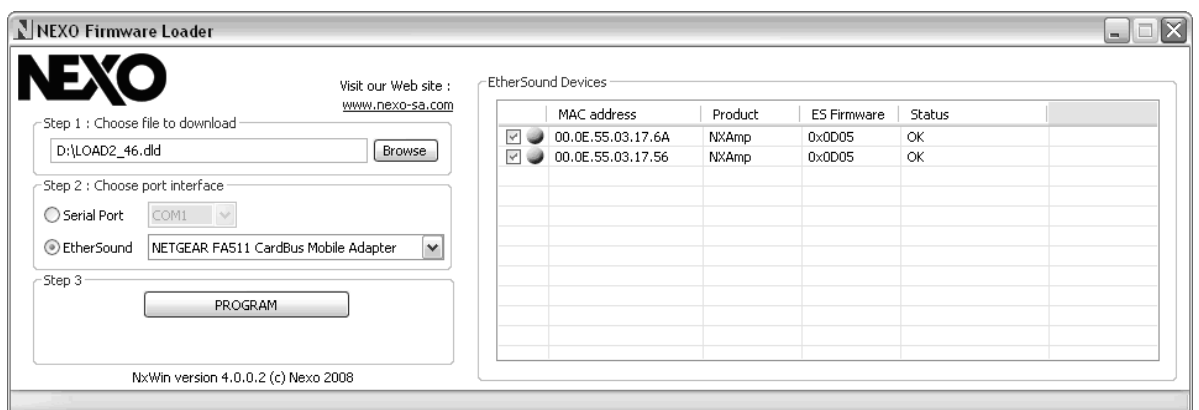

*Note: the firmware of the Ethersound board will be upgraded at the same time if included inside the LOAD file (.DLD file).*

**Put the NXAMP in download mode**

That means power the unit "ON" **while** having the 'mute 1' button down.

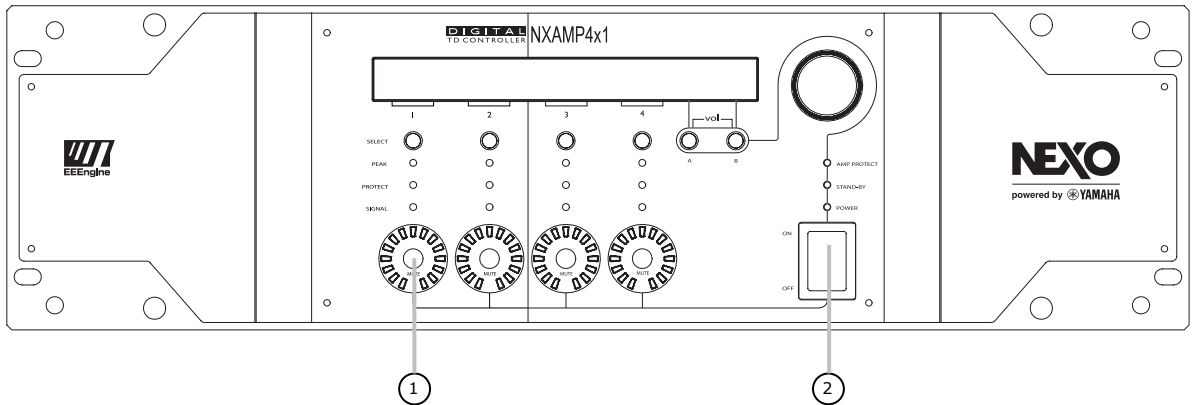

(1) Hold the mute 1 button down, and keep it down.

(2) Turn ON the NXAMP Powered TDcontroller.

The NXAMP screen will display the revision of the boot loader, and then the following message will appear:

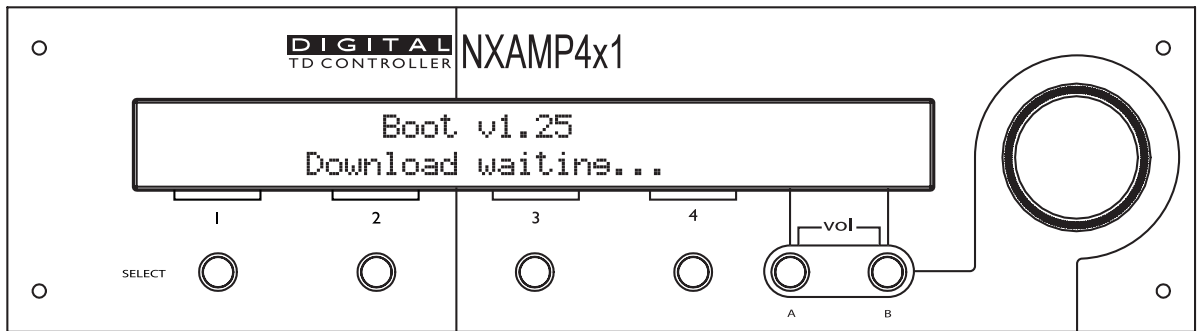

**Begin the upgrade**

You can now confirm the download in the splash screen. The Nxwin4 will detect the connected NXAMP target, and then download the appropriate software.



At the end of the download the NXAMP will start up normally, displaying the new firmware revision.

## Using the controller after a firmware update

### Choosing a cabinet setup

After the download of a new firmware, the NXAMP powered TDcontroller will be by default in FLAT mode, it means that the audio flows from the inputs to the outputs without treatment.

To load the wanted setup (for example GeoD or PS15, ...) you have to reset the unit by repressing buttons A, B & "Select CH1" for 3 seconds at least.

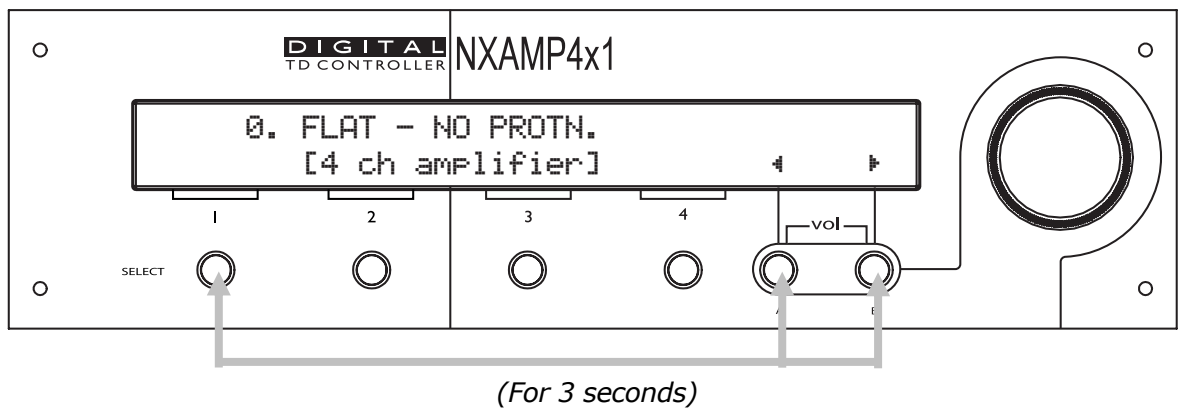

### Selecting cabinet family

Simultaneously repressing A & B buttons at power up or during device RESET accesses the system change menu. Keep the A & B Buttons held until the default display appears (approx. 20 seconds). This will allow the selection of any cabinet in any family. Using the rotary encoder, scroll through the configurations and press "B" to load the required settings.

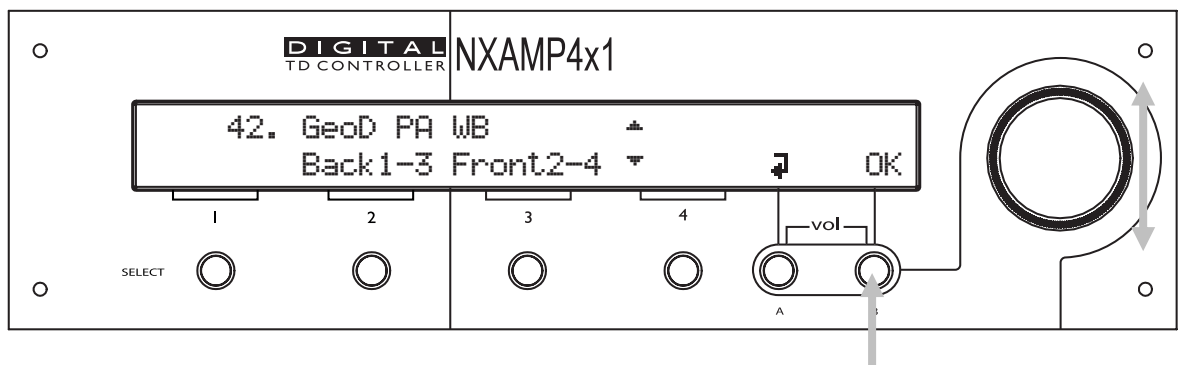

### Select your cabinet set-up

In the 'Options' menu, choose "System Config", and you will be able to choose among the different set-ups within the same cabinet family, (i.e. you don't have to modify the amplifier to cabinet wiring) or eventually between all families (see above).

## TECHNICAL SPECIFICATIONS

### POWER SPECIFICATIONS FOR NXAMP Powered TDcontroller

Number of channels	4 channels, 3 channels (2 non bridged + 1 bridged) or 2 channels (2 bridged)	
	<b>NXAMP4X1</b>	<b>NXAMP4X4</b>
Max. output power (8 Ω)	600 W (non bridged)	1900 W (non bridged)
	1800 W (2 channels bridged)	6600 W (2 channels bridged)
Max. output power (4 Ω)	900 W (non bridged)	3300 W (non bridged)
	2600 W (2 channels bridged mode)	8000 W (2 channels bridged)
Max. output power (2 Ω)	1300 W (non bridged)	4000 W (non bridged)
Power consumption	10 W Standby, 100 W Idle, 1100 W 1/8 Power	20 W Standby, 150 W Idle, 3000 W 1/8 Power

### SPECIFICATIONS FROM ANALOG IN TO POWER OUT

Analog Inputs channels	4 channels analog inputs on XLR 3 with a second XLR 3 for linking
Frequency response	+/- 0.5 dB from 10 Hz to 20 KHz
Input Impedance	20 KOhm.
Max Input Level	+28 dBu
Dynamic Range	All Channels = 105dB unweighted
THD + Noise	Typical 0.1% flat setup
Latency time	2.2 ms on a flat setup (Compatible with NX241 and NX242)
Power Supply	Dedicated version for 100 ~ 120 Volts or 220 ~ 240 Volts

### FRONT AND BACK PANEL FEATURES

Audio Inputs	<ul style="list-style-type: none"> <li>• 4 balanced analog inputs on XLR with link, using 24 bit converters.</li> <li>• 4 digital inputs via the optional network card slot at the back.</li> </ul>	
Power Outputs	4 Speakon outputs	
RS232 port	Allow firmware upgrade for software improvement and new cabinet setups.	
GPIO port	5 Global Purpose Inputs and 8 Global Purpose Outputs	
Front Panel	On/Off switch, Wheel, A/B buttons, 40 char x 2 display. Amp protect/Stand-by/Power LED's. For each ch: volume (15 LEDs), Mute w LED, Output current LED, Protect LED, Peak LED.	
Rear Panel	1 mains socket (2 for NXAMP4X4); RS232; GPIO, Expansion slot, 4 XLR w link, 4 Speakon 4	
	<b>NXAMP4X1</b>	<b>NXAMP4X4</b>
Dimensions & Weight	3U 19" Rack, 457 mm (18") Depth, 16.5kg (33 lbs) net	4U 19" Rack, 457 mm (18") Depth, 24.5kg (33 lbs) net

### USER CONTROLS

System Selection	Allows control from all NEXO ranges.
System Set-up	Within the selected range when possible, allows the cabinet to be set for passive/active mode, wideband/crossover mode, choose among crossover point, cardioid/supercardioid mode.
Protection	Multiple Peak Limiters fitted for both selected cabinet and amplifier. Multiple Acceleration, Displacement and Temperature protections on every channel.
Delay	Up to 66m (145 ft.) of delay in 10cm (.4in ) steps
Input Patching	Any of the 4 analog (or 8) inputs combination to be routed on each output.
Output Gain	Global and inter-channel gain +/-6dB in 0.5dB steps.
Volume control	Each channel with 16 steps from - inf dB to 0 dB.
Save/Recall	Set-up Stores 32 user set-ups
Array EQ	LF/HF shelving filters to compensate ground/stacking effects, +/-6dB
Security Mode	Password protected for Read-Only or Remote-Only Mode.
Remote control	Full remote control via the Ethersound protocol and ESmonitor software.
Certification	UL, SEMKO (CE), CCC, KOREA, TSS, PSE
Green status	Compliant with ROHS and WEEE directive



## Thermal dissipation and current drawn

Test signal: Pink Noise, bandwidth limited 22Hz to 22 kHz. All channels driven.

<b>NXAMP4X1</b>		Line Current (A)		Watts Dissipated	Thermal Dissipation	
		120V	230V		Btu/h	kcal/h
Idle		1.6	0.9	95	326	82
1/8out	8ohms/ch	11.1	6.1	390	1337	337
	4ohms/ch	16.7	9.2	590	2023	510
	2ohms/ch	21.8	12.0	620	2126	536

<b>NXAMP4X4</b>		Line Current (A)		Watts Dissipated	Thermal Dissipation	
		120V	230V		Btu/h	kcal/h
Idle		2.3	1.3	120	411	104
1/8out	8ohms/ch	26.0	14.3	800	2743	691
	4ohms/ch	40.0	22.0	1300	4457	1123
	2ohms/ch	50.0	27.5	1700	5829	1469

1 BTU = 1,055.06 J = 0.252 kcal

(W)\*864=cal

*N.B. These values are for NXAMP without NXES104 or NX-DFLT board fitted. If card is fitted, please add 5 Watts to these values.*

**Dimensions**

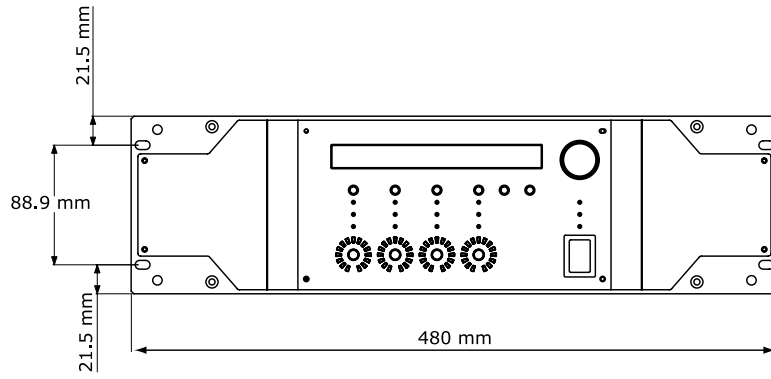

*NXAMP4X1 front view dimensions*

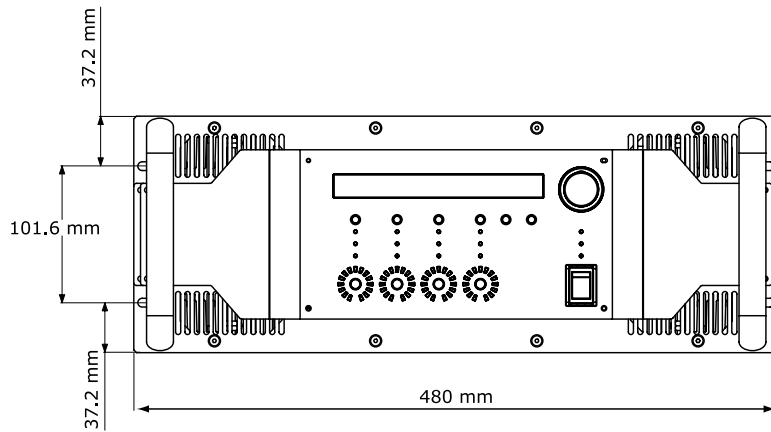

*NXAMP4X4 front view dimensions*

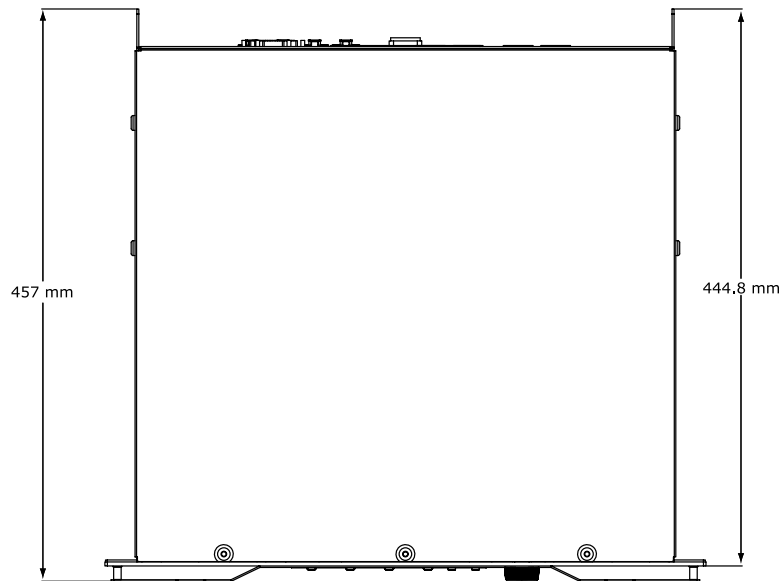

*NXAMP4X1 and NXAMP4X4 top view dimensions*

## Application Note: Driving the Sub from the AUX send

It is quite common to use the AUX send of a mixing desk to drive the Sub section of a PA system. This gives the mixing engineer more flexibility to set the level of its subbass relative to the main PA, apply special effects, use a different EQ on the Sub...However, it also rises some serious issues for the performance & safety of the system (mostly time alignment).

### What is the phase relation between the AUX and MAIN output of your Desk?

At NEXO, when we align systems, we take great care to have an optimum phase alignment from one octave above to one octave below the crossover frequency point. By doing so, we ensure that both drivers are working perfectly together and providing the best efficiency possible. It is then up to the user to adjust the delay on the NXAMP to match the physical path difference of the different systems. It is thus possible to get a well adjusted system, even without measuring instruments.

If you choose to drive the Sub from the AUX, you feed the NXAMP with two signals coming from different sources. If those two sources (MAIN output & AUX send) are not exactly in phase, you are introducing a delay –without knowing it- into the crossover between your main system and your sub. Without the proper measurement tools, you will never be able to tune the system as it should be.

### Why it is unlikely the AUX and MAIN have the same phase?

- Signal paths are likely to be different; any filter modifying the bandwidth and EQ of the signal is also affecting the phase.  
Example: a 24dB/oct high pass filter set at 15Hz is only affecting amplitude of the signal by 0.6dB at 30Hz but the phase shift is 90°!! At 100Hz we can still measure 25° of phase shift
- Should you want to restrict the bandwidth with a low pass filter, you can introduce a phase difference of up to 180° (completely out of phase) at the cross over point
- If the signal is passing through any digital equipment you are adding between 1.4ms and 2.2ms (around 70° phase shift at 100Hz) due to the converter delay only! The additional delay due to the processing itself (look ahead compressor, delay...) can be quite important

At the end of the day, if you have not measured both outputs in the actual configuration you can be 90% sure that you won't get the correct phase alignment that you would have had if the NXAMP was fed by a single source.

### Consequences of badly aligned systems

Mis-aligned systems have less efficiency: i.e. for the same SPL you will be obliged to drive the system harder, causing displacement & temperature protection at lower SPL than a properly aligned system. The sound quality will decrease. The reliability will decrease as the system is driven harder to achieve the same levels. In certain situations you may even need more speakers to do the same job...

Consider the simple example of the AUX signal passing through a digital device (without processing) that is adding a delay of 2ms due to its conversion time. The AUX is then sent to a CD12 sub while the MAIN is send to the S850 rig. The first graph display the phase around the crossover point (85Hz in this case)

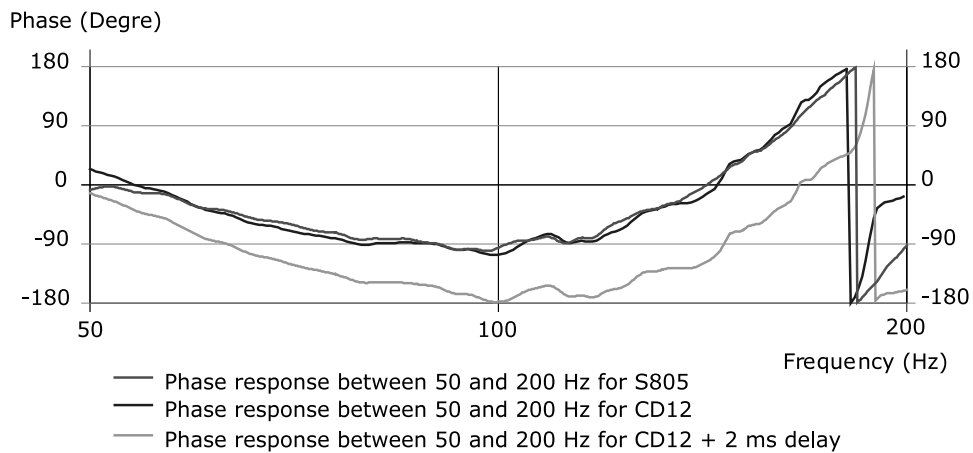

The two overlapping phases are those of the CD12 and S805 as they should be. The bellow curve is the same as the above one with a 2ms delay.

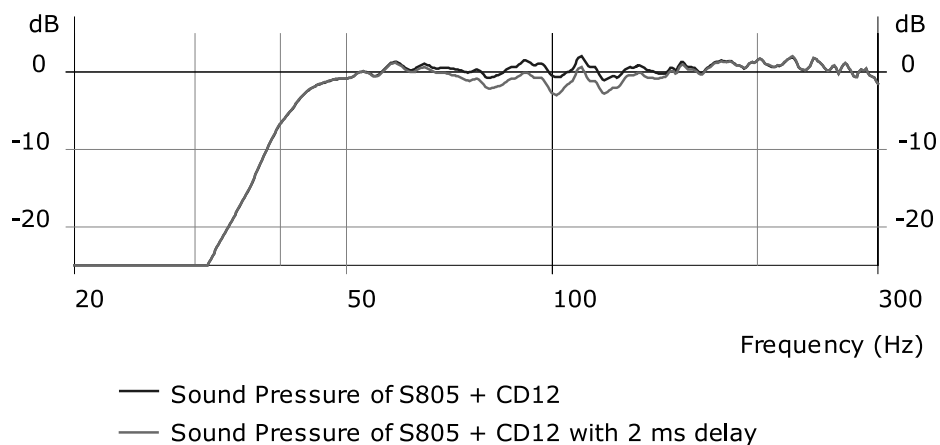

On the magnitude graph display the difference between the well aligned system and the one with the CD12 2ms delayed. The difference is 2dB at 100Hz. This example is displaying the consequences of a slightly incorrect alignment. If we add to this the delay introduced by a slightly different electric path plus the "small" delay introduced by some processing, plus an EQ filter done by the user near the cut off frequency...The graph above could shows differences in excess of 6dB. (Up to the point where the system might work better if you reverse the polarity of the sub!)

**Precautions & check**

Before using the AUX send of your desk ensure that the outputs are in phase (you can feed a 100Hz signal at the input and monitor the MAIN and AUX on a dual trace scope)

Always apply EQ or processing to all signals feeding the NXAMP. So the phase relation is not affected.

Never add additional low pass filtering on the SUB. (Or high pass to the main system)

Inverting polarity on one channel should always result in a massive difference near the crossover point. If the sound is more or less the same the system is no longer aligned.

## **Appendix A: List of Supported presets (LOAD2\_52)**

Please see the *LOAD2\_52\_setups.pdf* included in the documentation to see a complete list of presets supported in LOAD 2\_52 by the NXAMP. Please refer to the documentation enclosed with the firmware if the one loaded in your NXAMP is not LOAD 2\_52.

Keep in mind that you should hold the A & B buttons down when resetting the NXAMP Powered TD controller to switch from one family of setups to the other.

## Appendix B: How is measured the amplifier power?

This part of the document describes the setup we have used to measure the power available on the NXAMP Powered TDcontroller outputs for each load (8, 4 and 2 Ohms).

### General description of the setup

The drawing bellow shows the setup used to measure the output power:

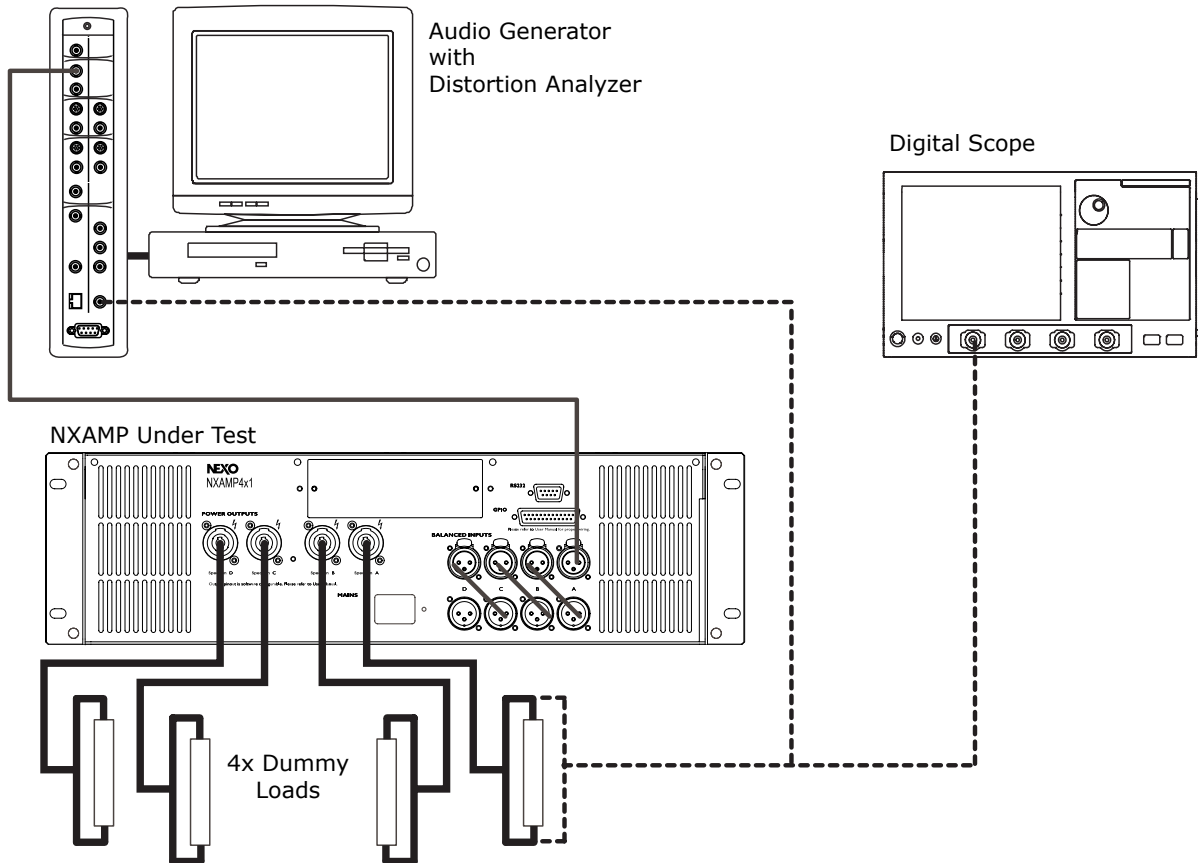

The Audio Generator with distortion analyzer is used to generate test signals. It analyzes the output of the amplifier to measure the THD+N, thus we can know when we reach the clip of the amplifier with a certain value of distortion (typically 1 %).

The NXAMP under test is powered through a monitored power supply with voltage adjusted to 230 Volts (+2/- 0 Volts) and 50 Hz.

The 4 analog inputs of the NXAMP Powered TDcontroller are linked together so all the channels are fed. DSP setup is "FLAT – NO PROT N", meaning that no EQ or gain is applied and that only the amplifier protections are working. The volume is set to 0 dB attenuation.

Each output of the amplifier is connected to a dummy load (8, 4 or 2 Ohms). On one channel, we loop the voltage back to the distortion analyzer and to a digital scope, to

measure directly the output voltage on the screen.

**Precision of the measurement**

- All the measurement tools (Digital scope and distortion analyzer) have been recently calibrated (less than one year).
- We've made some measurements on some batch of NXAMP to have a clear idea of the precision of the amplifier itself, from one unit to the other (small differences in the manufacturing of the custom transformer of the larges power supplies are the main factor for having different power capability).
- The precision on the dummy loads has also been checked with a calibrated ohmmeter.

Due to all this tolerances, we can compute a value for the power output of each channel of the amplifier in a precision of (+/- 10 %).

**Measurement method**

The input signal is a burst sine wave at 1 KHz, for 20 ms, every 500 ms. We increase the input level up to reaching 1 % THD+N on the distortion analyzer. We measure the signal with the scope cursor as shown in the picture bellow:

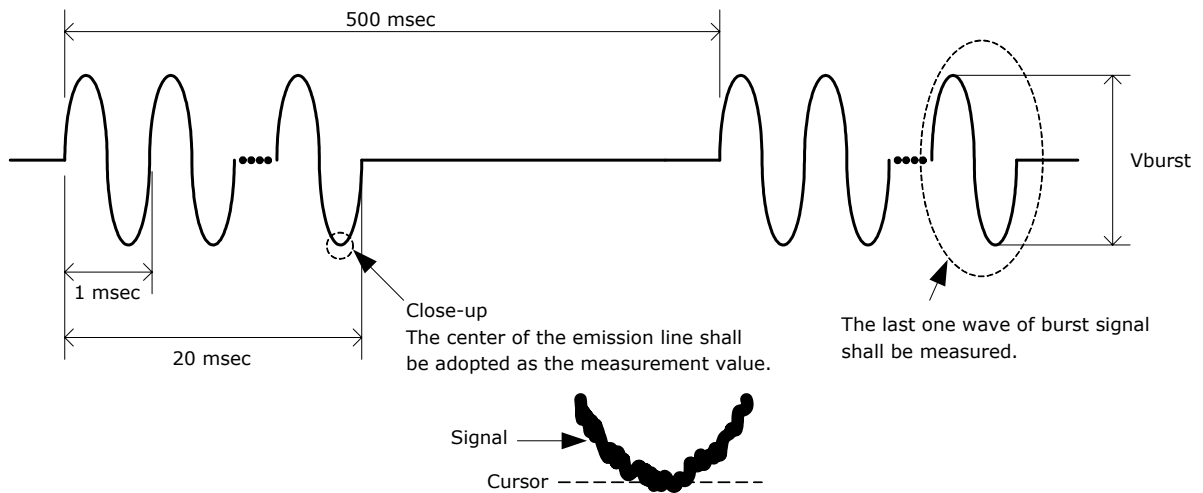

We do 4 measurements for each output, so we do 16 measurements per unit. Then we average on 4 units of NXAMP4X1C or NXAMP4X4C.

Then we redo the same with 4 units of NXAMP4X1U or NXAMP4X4U, mains being 120 Volts (+2, -0 Volts at 60 Hz).

Finally we average all the measurements and this is the values which are written in the datasheet of the NXAMP Powered TDcontrollers.



## Usable mains cord in Europe

The SEMKO (CE) certification in Europe is based on the assumption that the user will use one of the following mains cord to use NXAMP4X4 or NXAMP4X1. Please choose one from the list below.

<b>NXAMP4X1</b>					
PLUG		CORD		CONNECTOR	
WELL SHIN	WS-010	WELL SHIN	H05VV-F 3G 1.0mm <sup>2</sup>	WELL SHIN	WS-002-1
WELL SHIN	WS-010A	WELL SHIN	H05VV-F 3G 1.0mm <sup>2</sup>	WELL SHIN	WS-002-1
LONGWELL	LP-33	LONGWELL	H05VV-F 3G 1.0mm <sup>2</sup>	LONGWELL	LS-60
LONGWELL	LP-34A	LONGWELL	H05VV-F 3G 1.0mm <sup>2</sup>	LONGWELL	LS-60
VOLEX	M2511	VOLEX	H05VV-F 3G 1.0mm <sup>2</sup>	VOLEX	V1625
VOLEX	M2511A	VOLEX	H05VV-F 3G 1.0mm <sup>2</sup>	VOLEX	V1625
YUNG LI	YP-22	YUNG LI	H05VV-F 3G 1.0mm <sup>2</sup>	YUNG LI	YC-12
YUNG LI	YP-23	YUNG LI	H05VV-F 3G 1.0mm <sup>2</sup>	YUNG LI	YC-12

<b>NXAMP4X1 for UK</b>					
PLUG		CORD		CONNECTOR	
WELL SHIN	WS-012A	WELL SHIN	H05VV-F 3G 1.0mm <sup>2</sup>	WELL SHIN	WS-002-1
LONGWELL	LP-61L	LONGWELL	H05VV-F 3G 1.0mm <sup>2</sup>	LONGWELL	LS-60
VOLEX	MP5004	VOLEX	H05VV-F 3G 1.0mm <sup>2</sup>	VOLEX	V1625
YUNG LI	YP-60	YUNG LI	H05VV-F 3G 1.0mm <sup>2</sup>	YUNG LI	YC-12

<b>NXAMP4X4</b>					
PLUG		CORD		CONNECTOR	
WELL SHIN	WS-010	WELL SHIN	H05VV-F 3G 1.5mm <sup>2</sup>	Neutrik	NAC3FCA
WELL SHIN	WS-010A	WELL SHIN	H05VV-F 3G 1.5mm <sup>2</sup>	Neutrik	NAC3FCA
LONGWELL	LP-33	LONGWELL	H05VV-F 3G 1.5mm <sup>2</sup>	Neutrik	NAC3FCA
LONGWELL	LP-34A	LONGWELL	H05VV-F 3G 1.5mm <sup>2</sup>	Neutrik	NAC3FCA
VOLEX	M2511	VOLEX	H05VV-F 3G 1.5mm <sup>2</sup>	Neutrik	NAC3FCA
VOLEX	M2511A	VOLEX	H05VV-F 3G 1.5mm <sup>2</sup>	Neutrik	NAC3FCA

<b>NXAMP4X4 for UK</b>					
PLUG		CORD		CONNECTOR	
WELL SHIN	WS-012A	WELL SHIN	H05VV-F 3G 1.5mm <sup>2</sup>	Neutrik	NAC3FCA
LONGWELL	LP-61L	LONGWELL	H05VV-F 3G 1.5mm <sup>2</sup>	Neutrik	NAC3FCA
VOLEX	MP5004	VOLEX	H05VV-F 3G 1.5mm <sup>2</sup>	Neutrik	NAC3FCA

## ROHS certificate

部件名称	有毒有害物质或元素					
	铅 (Pb)	汞 (Hg)	镉 (Cd)	六价铬 (Cr (VI))	多溴联苯 (PBB)	多溴二苯醚 (PBDE)
外壳、框架	×	○	○	○	○	○
印刷线路板	×	○	×	○	○	○

○：表示该有毒有害物质在该部件所有均质材料中的含量均在SJ/T 11363-2006标准规定的限量要求以下。

×：表示该有毒有害物质至少在该部件的某一均质材料中的含量超出SJ/T 11363-2006标准规定的限量要求。

(此产品符合EU的RoHS指令。)

(この製品はEUのRoHS指令には適合しています。)

(This product conforms to the RoHS regulations in the EU.)

(Dieses Produkt entspricht der RoHS-Richtlinie der EU.)

(Ce produit est conforme aux réglementations RoHS de l'UE.)

(Este producto cumple con los requisitos de la directiva RoHS en la UE.)



此标识适用于在中华人民共和国销售的电子信息产品。  
标识中间的数字为环保使用期限的年数。

## User Notes

Nexo S.A.  
Parc d'Activité de la Dame Jeanne  
F-60128 PLAILLY

Tel: +33 3 44 99 00 70

Fax: +33 3 44 99 00 30

E-mail: [info@nexo.fr](mailto:info@nexo.fr)

[www.nexo-sa.com](http://www.nexo-sa.com)