

Pioneer

MULTI PLAYER

CDJ-850



<http://www.prodjnet.com/support/>

The Pioneer website listed above provides answers to frequently asked questions, information about software, and other up-to-date data of assistance to our customers.

<http://www.prodjnet.com/rekordbox/support/>

For inquiries on rekordbox, please see the support site indicated above.

Operating Instructions

Thank you for buying this Pioneer product. Please read through these operating instructions so you will know how to operate your model properly. After you have finished reading the instructions, put them away in a safe place for future reference. In some countries or regions, the shape of the power plug and power outlet may sometimes differ from that shown in the explanatory drawings. However the method of connecting and operating the unit is the same.

IMPORTANT



The lightning flash with arrowhead symbol, within an equilateral triangle, is intended to alert the user to the presence of uninsulated "dangerous voltage" within the product's enclosure that may be of sufficient magnitude to constitute a risk of electric shock to persons.

CAUTION

**RISK OF ELECTRIC SHOCK
DO NOT OPEN**



CAUTION:
TO PREVENT THE RISK OF ELECTRIC SHOCK, DO NOT REMOVE COVER (OR BACK). NO USER-SERVICEABLE PARTS INSIDE. REFER SERVICING TO QUALIFIED SERVICE PERSONNEL.

The exclamation point within an equilateral triangle is intended to alert the user to the presence of important operating and maintenance (servicing) instructions in the literature accompanying the appliance.

D3-4-2-1-1_A1_En

IMPORTANT SAFETY INSTRUCTIONS

- 1) Read these instructions.
- 2) Keep these instructions.
- 3) Heed all warnings.
- 4) Follow all instructions.
- 5) Do not use this apparatus near water.
- 6) Clean only with dry cloth.
- 7) Do not block any ventilation openings. Install in accordance with the manufacturer's instructions.
- 8) Do not install near any heat sources such as radiators, heat registers, stoves, or other apparatus (including amplifiers) that produce heat.
- 9) Do not defeat the safety purpose of the polarized or grounding-type plug. A polarized plug has two blades with one wider than the other. A grounding type plug has two blades and a third grounding prong. The wide blade or the third prong are provided for your safety. If the provided plug does not fit into your outlet, consult an electrician for replacement of the obsolete outlet.
- 10) Protect the power cord from being walked on or pinched particularly at plugs, convenience receptacles, and the point where they exit from the apparatus.
- 11) Only use attachments/accessories specified by the manufacturer.
- 12) Use only with the cart, stand, tripod, bracket, or table specified by the manufacturer, or sold with the apparatus. When a cart is used, use caution when moving the cart/apparatus combination to avoid injury from tip-over.
- 13) Unplug this apparatus during lightning storms or when unused for long periods of time.
- 14) Refer all servicing to qualified service personnel. Servicing is required when the apparatus has been damaged in any way, such as power-supply cord or plug is damaged, liquid has been spilled or objects have fallen into the apparatus, the apparatus has been exposed to rain or moisture, does not operate normally, or has been dropped.



P1-4-2-2_En

NOTE:

This equipment has been tested and found to comply with the limits for a Class B digital device, pursuant to Part 15 of the FCC Rules. These limits are designed to provide reasonable protection against harmful interference in a residential installation. This equipment generates, uses, and can radiate radio frequency energy and, if not installed and used in accordance with the instructions, may cause harmful interference to radio communications. However, there is no guarantee that interference will not occur in a particular installation. If this equipment does cause harmful interference to radio or television reception, which can be determined by turning the equipment off and on, the user is encouraged to try to correct the interference by one or more of the following measures:

- Reorient or relocate the receiving antenna.
- Increase the separation between the equipment and receiver.
- Connect the equipment into an outlet on a circuit different from that to which the receiver is connected.
- Consult the dealer or an experienced radio/TV technician for help.

D8-10-1-2_A1_En

WARNING

This equipment is not waterproof. To prevent a fire or shock hazard, do not place any container filled with liquid near this equipment (such as a vase or flower pot) or expose it to dripping, splashing, rain or moisture.

D3-4-2-1-3_A1_En

WARNING

Before plugging in for the first time, read the following section carefully.

The voltage of the available power supply differs according to country or region. Be sure that the power supply voltage of the area where this unit will be used meets the required voltage (e.g., 230 V or 120 V) written on the rear panel.

D3-4-2-1-4*_A1_En

WARNING

To prevent a fire hazard, do not place any naked flame sources (such as a lighted candle) on the equipment.

D3-4-2-1-7a_A1_En

VENTILATION CAUTION

When installing this unit, make sure to leave space around the unit for ventilation to improve heat radiation (at least 5 cm at rear, and 5 cm at each side).

WARNING

Slots and openings in the cabinet are provided for ventilation to ensure reliable operation of the product, and to protect it from overheating. To prevent fire hazard, the openings should never be blocked or covered with items (such as newspapers, table-cloths, curtains) or by operating the equipment on thick carpet or a bed.

D3-4-2-1-7b*_A1_En

Operating Environment

Operating environment temperature and humidity: +5 °C to +35 °C (+41 °F to +95 °F); less than 85 %RH (cooling vents not blocked)

Do not install this unit in a poorly ventilated area, or in locations exposed to high humidity or direct sunlight (or strong artificial light)

D3-4-2-1-7c*_A1_En

If the AC plug of this unit does not match the AC outlet you want to use, the plug must be removed and appropriate one fitted. Replacement and mounting of an AC plug on the power supply cord of this unit should be performed only by qualified service personnel. If connected to an AC outlet, the cut-off plug can cause severe electrical shock. Make sure it is properly disposed of after removal. The equipment should be disconnected by removing the mains plug from the wall socket when left unused for a long period of time (for example, when on vacation).

D3-4-2-2-1a_A1_En

CAUTION

The  switch on this unit will not completely shut off all power from the AC outlet. Since the power cord serves as the main disconnect device for the unit, you will need to unplug it from the AC outlet to shut down all power. Therefore, make sure the unit has been installed so that the power cord can be easily unplugged from the AC outlet in case of an accident. To avoid fire hazard, the power cord should also be unplugged from the AC outlet when left unused for a long period of time (for example, when on vacation).

D3-4-2-2a*_A1_En

NOTE

THE NO USER-SERVICEABLE PARTS COMPARTMENT WARNING IS LOCATED ON THE APPLIANCE BOTTOM.

D3-7-13-68_A1_En

This Class B digital apparatus complies with Canadian ICES-003.

D8-10-1-3_A1_En

Information to User

Alterations or modifications carried out without appropriate authorization may invalidate the user's right to operate the equipment.

D8-10-2_A1_En

CAUTION

This product satisfies FCC regulations when shielded cables and connectors are used to connect the unit to other equipment. To prevent electromagnetic interference with electric appliances such as radios and televisions, use shielded cables and connectors for connections.

D8-10-3a_A1_En

IMPORTANT NOTICE

THE MODEL NUMBER AND SERIAL NUMBER OF THIS EQUIPMENT ARE ON THE REAR OR BOTTOM. RECORD THESE NUMBERS ON PAGE 31 FOR FUTURE REFERENCE.

D36-AP9-1_A1_En_PSV

WARNING: Handling the cord on this product or cords associated with accessories sold with the product may expose you to chemicals listed on proposition 65 known to the State of California and other governmental entities to cause cancer and birth defect or other reproductive harm.
Wash hands after handling.

D36-P5_B1_En

When using this product, confirm the safety information shown on the bottom of the unit.

D3-4-2-2-4_B1_En

CAUTION

This product is a class 1 laser product classified under the Safety of laser products, IEC 60825-1:2007.

CLASS 1 LASER PRODUCT

D58-5-2-2a_A1_En

This product contains mercury. Disposal of this material may be regulated due to environmental considerations. For disposal or recycling information, please contact your local authorities or the Electronics Industries Alliance : www.eiae.org.

K057_A1_En

POWER-CORD CAUTION

Handle the power cord by the plug. Do not pull out the plug by tugging the cord and never touch the power cord when your hands are wet as this could cause a short circuit or electric shock. Do not place the unit, a piece of furniture, etc., on the power cord, or pinch the cord. Never make a knot in the cord or tie it with other cords. The power cords should be routed such that they are not likely to be stepped on. A damaged power cord can cause a fire or give you an electrical shock. Check the power cord once in a while. When you find it damaged, ask your nearest PIONEER authorized service center or your dealer for a replacement.

S002*_A1_En

FEDERAL COMMUNICATIONS COMMISSION DECLARATION OF CONFORMITY

This device complies with part 15 of the FCC Rules. Operation is subject to the following two conditions: (1) This device may not cause harmful interference, and (2) this device must accept any interference received, including interference that may cause undesired operation.

Product Name: MULTI PLAYER

Model Number: CDJ-850

Responsible Party Name: PIONEER ELECTRONICS (USA) INC.
SERVICE SUPPORT DIVISION

Address: 1925 E. DOMINGUEZ ST. LONG BEACH, CA 90810-1003, U.S.A.

Phone: 1-800-421-1404

URL: <http://www.pioneerelectronics.com>

D8-10-4*_C1_En



Dear Customer:

Selecting fine audio equipment such as the unit you've just purchased is only the start of your musical enjoyment. Now it's time to consider how you can maximize the fun and excitement your equipment offers. This manufacturer and the Electronic Industries Association's Consumer Electronics Group want you to get the most out of your equipment by playing it at a safe level. One that lets the sound come through loud and clear without annoying blaring or distortion-and, most importantly, without affecting your sensitive hearing.

Sound can be deceiving. Over time your hearing "comfort level" adapts to higher volumes of sound. So what sounds "normal" can actually be loud and harmful to your hearing. Guard against this by setting your equipment at a safe level BEFORE your hearing adapts.

To establish a safe level:

- Start your volume control at a low setting.
- Slowly increase the sound until you can hear it comfortably and clearly, and without distortion.

Once you have established a comfortable sound level:

- Set the dial and leave it there.

Taking a minute to do this now will help to prevent hearing damage or loss in the future. After all, we want you listening for a lifetime.

We Want You Listening For A Lifetime

Used wisely, your new sound equipment will provide a lifetime of fun and enjoyment. Since hearing damage from loud noise is often undetectable until it is too late, this manufacturer and the Electronic Industries Association's Consumer Electronics Group recommend you avoid prolonged exposure to excessive noise. This list of sound levels is included for your protection.

Decibel Level Example

30	Quiet library, soft whispers
40	Living room, refrigerator, bedroom away from traffic
50	Light traffic, normal conversation, quiet office
60	Air conditioner at 20 feet, sewing machine
70	Vacuum cleaner, hair dryer, noisy restaurant
80	Average city traffic, garbage disposals, alarm clock at two feet.

THE FOLLOWING NOISES CAN BE DANGEROUS UNDER CONSTANT EXPOSURE

90	Subway, motorcycle, truck traffic, lawn mower
100	Garbage truck, chain saw, pneumatic drill
120	Rock band concert in front of speakers, thunderclap
140	Gunshot blast, jet plane
180	Rocket launching pad

Information courtesy of the Deafness Research Foundation.



S001_A1_En

Contents

How to read this manual

The names of displays, menus, and buttons in this manual are enclosed in brackets. (e.g. [MASTER] channel, [ON/OFF], [File] menu)

- The Operating Instructions of rekordbox can be viewed from the rekordbox [Help] menu after installing rekordbox.

01 Before start

Features 6

02 Before you start

What's in the box..... 7
Supported sources..... 7
Usable discs and USB devices 7
Playable music file formats..... 8
Functions usable in combination with a computer 9
About the rekordbox music management software 10
About the driver software (Windows)..... 11

03 Part names and functions

Control panel 13
Rear panel..... 14
Front panel..... 14
Main unit display..... 15
Jog dial display section..... 15

04 Connections

Basic style..... 16

05 Operations

Setting the source to be played 17
Using the [BROWSE] button 17
Using the [TAG LIST] button..... 18
Using the [INFO] button 19
Playback..... 20
Setting Cue 20
Setting Loop..... 21
Storing cue and loop points 22
Adjusting the playing speed (Tempo control) 23
Operating the jog dial 23
Operations in combination with a DJ mixer 24
Using the DJ software 24
Changing the settings 24

06 Additional information

Troubleshooting 26
Error messages 27
List of MIDI Messages 27
List of icons displayed on the main unit display section 28
Cautions on use 28
Handling discs 28
Disclaimer..... 28
Cautions on copyrights..... 29
Using the support site 29
Specifications..... 29

Before start

Features

This unit is a DJ player that carries over the technology of the Pioneer CDJ series, the world standard in club players. It is a multi player for DJs supporting a variety of sources, enabling full-fledged DJ play easily.

MULTI MEDIA, MULTI FORMAT

This unit can play not only music CDs (CD-DA), but also music files (MP3, AAC, WAV and AIFF) recorded on mass storage class USB devices (flash memory devices and hard discs) and CD-R/-RW discs. It can also be used as DJ software controller and audio interface.

rekordbox™

rekordbox, a music management software application exclusively for Pioneer DJ players, is included. It allows music files on a computer to be managed in a variety of ways (analysis, setting, creation, storage of playback history, etc.). Also, music files managed with rekordbox can be transferred to USB devices for convenience in selecting tracks, operating playlists and so on when the USB device is connected to this unit.

USB Export

This function can be used to transfer rekordbox music files and management data using USB devices. This eliminates the need to take your computer to the disco or club.

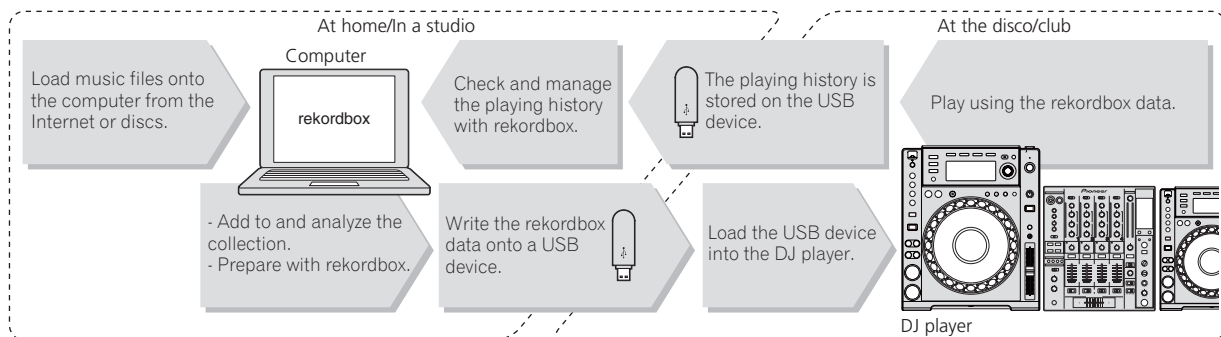

DISPLAY

The combination of a GUI displaying music file information in easily understandable fashion and a rotary selector with easy operation lets you select tracks with no stress.

WAVE DISPLAY

This unit is equipped with a 100 x 7 dot WAVE display.

TAG LIST

In addition to playlists prepared using rekordbox, tracks to be played next can be temporarily collected inside the CDJ-850. The music files added to the tag list can be displayed as a list. This function is extremely convenient for selecting tracks during live performances.

KEYWORD SEARCH

Keyword searching, letter jumping and other functions let you quickly and precisely search for the desired music file.

HISTORY MEMORY

The CDJ-850 is equipped with a history function storing the playing history of music files. Playlists can be created from this playing history using rekordbox.

Before you start

What's in the box

- CD-ROM (rekordbox license key attached)
- Power cord
- Audio cable
- Control cord
- Disc force eject pin (mounted on bottom of product)
- Operating instructions (this document)

Supported sources

This unit supports the sources listed below.

- Discs (page 7)
- USB devices (page 8)
- Computers (page 9)





Install the software onto the computer from the included CD-ROM. The included CD-ROM contains the following two software programs.

- rekordbox music management software
- Driver software

Usable discs and USB devices

About discs

This unit can play the discs shown below.

Type	Mark ¹	Compatible formats
CD		<ul style="list-style-type: none">• Music CD (CD-DA)
CD-R		<ul style="list-style-type: none">• Music CD (CD-DA)• MP3• AAC• WAV• AIFF
CD-RW		
CD-TEXT ²		Music CD (CD-DA)

¹ Discs on which the marks on this table are indicated on the disc label, package or jacket can be played.

² Titles, album names and artist names recorded in the CD-Text data are displayed. When multiple text data are recorded on the disc, the information for the first text data is displayed.

❖ Discs that cannot be played

- DTS-CD
- Photo CDs
- Video CDs
- CD Graphics (CD-G) discs
- Unfinalized CDs
- DVD

❖ About CD-R/-RW discs

Music files (MP3/AAC/WAV/AIFF) recorded on CD-R/-RW discs can be played.

Folder layers	Max. 8 levels (files in folders beyond the 8th level cannot be played)
Max. number of folders	1 000 folders
Max. number of files	1 000 files

When there are many folders or files, some time may be required for loading.

❖ About discs created on computers

Depending on the application settings and the computer's environmental settings, it may not be possible to play certain discs. Record the disc in a format supported on this unit. For details, contact your application's retailer.

If the recording quality is poor due to the disc's properties, scratches or dirt on the disc or dirt on the recording lens, it may not be possible to play the disc.

❖ Creating backup discs

When CD-R/-RW discs are paused or left in the pause mode at cue points for long periods of time, it may become difficult to play the disc at that point, due to the properties of the disc. Also, when a specific point is looped repeatedly an extremely large number of times, it may become difficult to play that point.

When playing valuable discs, we recommend making backup discs.

❖ About Copy Control CDs and DualDiscs

This unit is designed to CD standards. Operation and performance of discs with standards other than CD standards is not guaranteed.

❖ About 8 cm single CDs

8 cm single CDs cannot be played on the CDJ-850. Do not mount 8 cm adapters on CDs and play them on the CDJ-850. The adapter could fall off as the disc spins, damaging the disc or the player.

About USB devices

This unit supports USB mass storage class USB devices (external hard disks, portable flash memory devices, digital audio players, etc.).

Folder layers	Max. 8 layers
Max. number of folders	1 000 folders
Max. number of files	10 000 files (1 000 files for files not managed by rekordbox)
Supported file systems	FAT16, FAT32 and HFS+ (NTFS is not supported.)

When there are many folders or files, some time may be required for loading. Folders and files exceeding the limits cannot be displayed.

❖ USB devices that cannot be used

- Optical disk type devices such as external DVD/CD drives, etc., are not supported.
- USB hubs cannot be used.

❖ Cautions on using USB devices

- Some USB devices may not operate properly. Please note that Pioneer will accept no responsibility whatsoever for loss of data recorded on USB devices.
- It may happen that, when a current above the allowable level is detected in this unit's USB port, the [USB STOP] indicator flashes, the power supply to the USB device is cut off and communications with the USB device are interrupted. To restore normal operation, disconnect the USB device from this unit. Avoid reusing USB devices for which an excess current has been detected. If normal operation is not restored (if communications cannot be established) after the above procedure is performed, try turning off this unit's power then turning it back on.
- If multiple partitions are set for the USB device, the device may not be recognized.
- USB devices equipped with flash card readers may not operate.
- Depending on the USB device you are using, the desired performance may not be achieved.

Playable music file formats

This unit supports music files in the formats shown below.

Type	File extension	Compatible formats	Bit depth	Bit rate	Sampling frequency	Encoding method
MP3	.mp3	MPEG-1	16 bit	32 kbps to 320 kbps	32 kHz, 44.1 kHz, 48 kHz	CBR, VBR
AAC	.m4a, .aac and .mp4	MPEG-4 AAC LC	16 bit	16 kbps to 320 kbps	32 kHz, 44.1 kHz, 48 kHz	CBR, VBR
WAV	.wav	WAV	16 bit, 24 bit	—	44.1 kHz, 48 kHz	Uncompressed PCM
AIFF	.aif, .aiff	AIFF	16 bit, 24 bit	—	44.1 kHz, 48 kHz	Uncompressed PCM

About MP3 files

MP3 files can have a constant bit rate (CBR) or a variable bit rate (VBR). Both types of files can be played on the CDJ-850, but the search and super fast search functions are slower with VBR files. If your priority is operability, we recommend recording MP3 files in CBR.

About AAC files

- AAC is the abbreviation of "Advanced Audio Coding", a basic format of audio compression technology used for MPEG-2 and MPEG-4.
- The file format and extension of AAC data depends on the application used to create the data.
- In addition to AAC files with the extension ".m4a" encoded with iTunes®, files with the extensions ".aac" and ".mp4" can also be played. Note, however, that copyright-protected AAC files purchased for example at the iTunes Music Store cannot be played. Also, some files may not be playable, depending on the version of iTunes used for encoding.

Functions usable in combination with a computer

About the included CD-ROM

This unit can be used in combination with a computer when the software is installed onto the computer from the included CD-ROM. The included CD-ROM contains the following two software programs.

❖ rekordbox music management software

Music files used for DJ play can be managed. The management information can be transferred using USB devices (page 10).

❖ Driver software

When operating DJ software on the computer using this unit, the sound of the music file that is playing can be output from this unit (page 11).

- There is no need to install the driver software when using Mac OS X.

Software end user license agreement

This Software End User License Agreement ("Agreement") is between you (both the individual installing the Program and any single legal entity for which the individual is acting) ("You" or "Your") and PIONEER CORPORATION ("Pioneer"). TAKING ANY STEP TO SET UP OR INSTALL THE PROGRAM MEANS THAT YOU ACCEPT ALL OF THE TERMS OF THIS LICENSE AGREEMENT. PERMISSION TO DOWNLOAD AND/OR USE THE PROGRAM IS EXPRESSLY CONDITIONED ON YOUR FOLLOWING THESE TERMS. WRITTEN OR ELECTRONIC APPROVAL IS NOT REQUIRED TO MAKE THIS AGREEMENT VALID AND ENFORCEABLE. IF YOU DO NOT AGREE TO ALL OF THE TERMS OF THIS AGREEMENT, YOU ARE NOT AUTHORIZED TO USE THE PROGRAM AND MUST STOP INSTALLING IT OR UNINSTALL IT, AS APPLICABLE.

1 Definitions

- 1 "Documentation" means written documentation, specifications and help content made generally available by Pioneer to aid in installing and using the Program.
- 2 "Program" means all or any part of Pioneer's software licensed to You by Pioneer under this Agreement.

2 Program license

- 1 Limited License. Subject to this Agreement's restrictions, Pioneer grants to You a limited, non-exclusive, nontransferable, license (without the right to sublicense):
 - a To install a single copy of the Program on the hard disk drive of Your computer, to use the Program only for Your personal purpose complying with this Agreement and the Documentation ("Authorized Use");
 - b To use the Documentation in support of Your Authorized Use; and
 - c To make one copy of the Program solely for backup purposes, provided that all titles and trademark, copyright and restricted rights notices are reproduced on the copy.
- 2 Restrictions. You will not copy or use the Program or Documentation except as expressly permitted by this Agreement. You will not transfer, sublicense, rent, lease or lend the Program, or use it for third-party training, commercial time-sharing or service bureau use. You will not Yourself or through any third party modify, reverse engineer, disassemble or decompile the Program, except to the extent expressly permitted by applicable law, and then only after You have notified Pioneer in writing of Your intended activities. You will not use the Program on multiple processors without Pioneer's prior written consent.
- 3 Ownership. Pioneer or its licensor retains all right, title and interest in and to all patent, copyright, trademark, trade secret and other intellectual property rights in the Program and

Documentation, and any derivative works thereof. You do not acquire any other rights, express or implied, beyond the limited license set forth in this Agreement.

- 4 No Support. Pioneer has no obligation to provide support, maintenance, upgrades, modifications or new releases for the Program or Documentation under this Agreement.

3 Warranty disclaimer

THE PROGRAM AND DOCUMENTATION ARE PROVIDED "AS IS" WITHOUT ANY REPRESENTATIONS OR WARRANTIES, AND YOU AGREE TO USE THEM AT YOUR SOLE RISK. TO THE FULLEST EXTENT PERMISSIBLE BY LAW, PIONEER EXPRESSLY DISCLAIMS ALL WARRANTIES OF ANY KIND WITH RESPECT TO THE PROGRAM AND DOCUMENTATION, WHETHER EXPRESS, IMPLIED, STATUTORY, OR ARISING OUT OF COURSE OF PERFORMANCE, COURSE OF DEALING OR USAGE OF TRADE, INCLUDING ANY WARRANTIES OF MERCHANTABILITY, FITNESS FOR A PARTICULAR PURPOSE, SATISFACTORY QUALITY, ACCURACY, TITLE OR NON-INFRINGEMENT.

4 Damages and remedies for breach

You agree that any breach of this Agreement's restrictions would cause Pioneer irreparable harm for which money damages alone would be inadequate. In addition to damages and any other remedies to which Pioneer may be entitled, You agree that Pioneer may seek injunctive relief to prevent the actual, threatened or continued breach of this Agreement.

5 Termination

Pioneer may terminate this Agreement at any time upon Your breach of any provision. If this Agreement is terminated, You will stop using the Program, permanently delete it from the computer where it resides, and destroy all copies of the Program and Documentation in Your possession, confirming to Pioneer in writing that You have done so. Sections 2.2, 2.3, 2.4, 3, 4, 5 and 6 will continue in effect after this Agreement's termination.

6 General terms

- 1 Limitation of Liability. In no event will Pioneer or its subsidiaries be liable in connection with this Agreement or its subject matter, under any theory of liability, for any indirect, incidental, special, consequential or punitive damages, or damages for lost profits, revenue, business, savings, data, use, or cost of substitute procurement, even if advised of the possibility of such damages or if such damages are foreseeable. In no event will Pioneer's liability for all damages exceed the amounts actually paid by You to Pioneer or its subsidiaries for the Program. The parties acknowledge that the liability limits and risk allocation in this Agreement are reflected in the Program price and are essential elements of the bargain between the parties, without which Pioneer would not have provided the Program or entered into this Agreement.
- 2 The limitations or exclusions of warranties and liability contained in this Agreement do not affect or prejudice Your statutory rights as consumer and shall apply to You only to the extent such limitations or exclusions are permitted under the laws of the jurisdiction where You are located.
- 3 Severability and Waiver. If any provision of this Agreement is held to be illegal, invalid or otherwise unenforceable, that provision will be enforced to the extent possible or, if incapable of enforcement, deemed to be severed and deleted from this Agreement, and the remainder will continue in full force and effect. The waiver by either party of any default or breach of this Agreement will not waive any other or subsequent default or breach.
- 4 No Assignment. You may not assign, sell, transfer, delegate or otherwise dispose of this Agreement or any rights or obligations under it, whether voluntarily or involuntarily, by operation of law or otherwise, without Pioneer's prior written consent. Any purported assignment, transfer or delegation by You will be null and void. Subject to the foregoing, this Agreement will be binding upon and will inure to the benefit of the parties and their respective successors and assigns.
- 5 Entire Agreement. This Agreement constitutes the entire agreement between the parties and supersedes all prior or contemporaneous agreements or representations, whether

written or oral, concerning its subject matter. This Agreement may not be modified or amended without Pioneer's prior and express written consent, and no other act, document, usage or custom will be deemed to amend or modify this Agreement.

- 6 You agree that this Agreement shall be governed and construed by and under the laws of Japan.

Cautions on installing the software

Read *Software end user license agreement* carefully before installing rekordbox and the driver software.

- The included CD-ROM contains installation programs in the following 12 languages.
English, French, German, Italian, Dutch, Spanish, Portuguese, Russian, Chinese (simplified characters), Chinese (traditional characters), Korean, Japanese.
- When using rekordbox with an operating system in a different language, follow the instructions on the screen to select [English].

Supported operating systems	rekordbox	Driver software
Mac OS X (10.4.6 and later)	✓	①
Windows® 7 Home Premium/Professional/Ultimate	32-bit version	✓
	64-bit version	✓②
Windows Vista® Home Basic/Home Premium/Business/Ultimate	32-bit version	✓
	64-bit version	✓②
Windows® XP Home edition/Professional (SP2 and later)	32-bit version	✓

① There is no need to install the driver software when using Mac OS X.

② When using a 64-bit version of Windows, the driver software can only be used for 32-bit applications.

❖ Minimum operating environment for rekordbox

- CPU:
 - For Mac OS X, Macintosh computer equipped with a 1.83 GHz or greater Intel® Core™ Duo (or compatible) processor
 - For Windows® 7, Windows Vista® and Windows® XP, PC/AT compatible computer equipped with a 2 GHz or greater Intel® Pentium® 4 (or compatible) processor
- Required memory: 1 GB or more of RAM
- Hard disc: 250 MB or more of free space (not including space for storing music files, etc.)
- CD drive: Optical disc drive on which the CD-ROM can be read
- Sound: Audio output to speakers, headphones, etc. (internal or external audio device)
- Internet connection: For user registration and inquiries, use a web browser supporting 128-bit SSL (Safari 2.0 or greater, Internet Explorer® 6.0 or greater, etc.).
- USB port: A USB port for connection of a USB device (flash memory, hard disc, etc.) is required to transfer music files to the USB device.

- Operation is not guaranteed on all computers, even those with the operating environment described above.
- Even with the required memory capacity indicated for the operating environment above, in the cases described below the software may not provide full functionality and performance due to lack of memory. In this case, take the necessary measures to ensure sufficient free memory. We recommend adding extra memory in order to achieve stable performance.
 - When there are many tracks being managed in the rekordbox library
 - When resident programs and services are running
- Depending on the computer's power settings, etc., the CPU and hard disc processing capacity may be insufficient. When using laptop computers in particular, always keep the AC power connected and set the computer to maximum performance conditions when using rekordbox.
- Note that problems may arise in the operation of rekordbox due to other software being used together with it.

About the rekordbox music management software

rekordbox is a software program for purchasers of the CDJ-850 or other Pioneer DJ players to manage the music files they use for DJ play.

- rekordbox may be used for classifying and searching for music files stored on your computer as well as creating playlists, all of which can help improve your DJ performance.
- rekordbox allows the detecting, measuring, and editing of beats, tempos (BPM), and other elements of your music files prior to a performance.

Installing rekordbox

❖ About the installation procedure (Macintosh)

Read *Cautions on installing the software* carefully before installing rekordbox.

- Authorization of the computer's administrator is required to install and uninstall rekordbox.
Log on as the user which was set as the computer's administrator before installing.

1 When the included CD-ROM is inserted into the computer's CD drive, the CD drive opens on the screen. Double-click the [CD_menu.app] icon.

- If the CD drive does not open on the screen when the CD-ROM is inserted, use Finder to open the CD drive, then double-click the [CD_menu.app] icon.

<[CD.menu.app] icon>

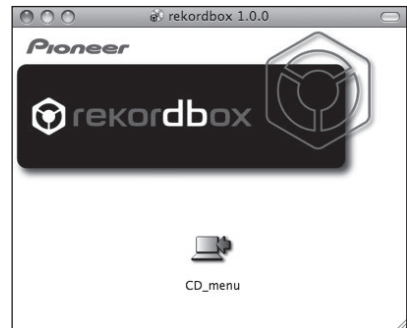

2 When the CD-ROM's menu is displayed, select [rekordbox: Install Music Management Software], then click [Start].

<CD-ROM menu>

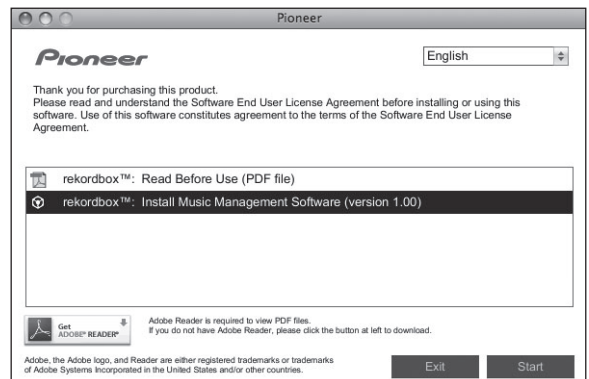

- To close the CD-ROM menu, click [Exit].

3 Install rekordbox following the instructions on the screen.

❖ About the installation procedure (Windows)

Read *Cautions on installing the software* carefully before installing rekordbox.

- Authorization of the computer's administrator is required to install and uninstall rekordbox.
Log on as the user registered as the computer's administrator before installing rekordbox.

1 Insert the included CD-ROM into the computer's CD drive.

The CD-ROM menu is displayed.

- If the CD-ROM menu does not appear when the CD-ROM is inserted, open the CD drive from [Computer (or My Computer)] in the [START] menu, then double-click the [CD_menu.exe] icon.

2 When the CD-ROM's menu is displayed, select [rekordbox: Install Music Management Software], then click [Start].

<CD-ROM menu>

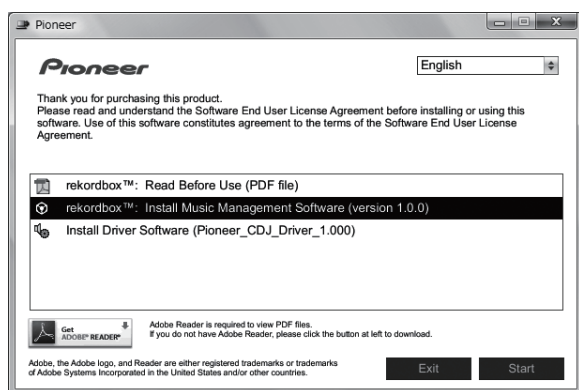

- To close the CD-ROM menu, click [Exit].

3 Install rekordbox following the instructions on the screen.

- Click [Cancel] to cancel installation after it has started.

Launching rekordbox

Log on as the user which was set as the computer's administrator before using rekordbox.

- When rekordbox is started up for the first time, the license key must be input. The license key is affixed to the CD-ROM package.
- When rekordbox is started up, the operating instructions can be viewed from the rekordbox [Help] menu.

❖ For Mac OS X

Open the [Application] folder with Finder, then double-click [rekordbox 1.x.x.app].

- The 1.x.x indicates the rekordbox version.

❖ For Windows® 7, Windows Vista® and Windows® XP

Click on the Windows [START] menu button, then [All Programs] > [Pioneer] > [rekordbox 1.x.x] > [rekordbox 1.x.x].

- The 1.x.x indicates the rekordbox version.

About the driver software (Windows)

This driver software is an exclusive ASIO driver for outputting audio signals from the computer. To use the CDJ-850 connected to a computer on which Windows is installed, install the driver software on the computer beforehand.

Installing the driver software

❖ Before installing the driver software

- Read *Cautions on installing the software* on page 10 carefully.
- Turn off this unit's power switch, then disconnect the USB cable connecting this unit and the computer.
- If any other programs are running on the computer, quit them.
- To install or uninstall the driver software, you need to be authorized by the administrator of your computer. Log on as the administrator of your computer before proceeding with the installation.
- If you connect this unit to your computer without installing the driver software first, an error may occur on your computer depending on the system environment.
- If installation of the driver software is interrupted after it has started, start the installation procedure over again from the beginning.

1 Insert the included CD-ROM into the computer's CD drive.

The CD-ROM menu is displayed.

- If the CD-ROM menu does not appear when the CD-ROM is inserted, open the CD drive from [Computer (or My Computer)] in the [START] menu, then double-click the [CD_menu.exe] icon.

2 When the CD-ROM menu appears, select [Install Driver Software (Pioneer_CDJ_Driver)], then click [Start].

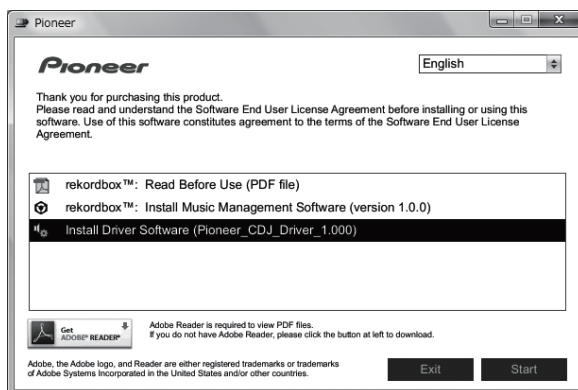

- To close the CD-ROM menu, click [Exit].

3 Proceed with installation according to the instructions on the screen.

If [Windows Security] appears on the screen while the installation is in progress, click [Install this driver software anyway] and continue with the installation.

- When installing on Windows XP
If [Hardware Installation] appears on the screen while the installation is in progress, click [Continue Anyway] and continue with the installation.
- When the installation program is completed, a completion message appears.

Connecting the CDJ-850 and computer

1 Connect this unit to your computer via a USB cable.

For instructions on connecting, see *Using DJ software* on page 16.

2 Press [⏻] 88.

Turn on the power of this unit.

3 Press [PC] 16.

The [CONNECTED] screen appears on the main unit display.

- The message [Installing device driver software] may appear when the CDJ-850 is connected to the computer for the first time or when it is reconnected to the computer's USB port. Wait until the [Your devices are ready for use] message appears.
- When installing on Windows XP
 - [Can Windows connect to Windows Update to search for software?] may appear while the installation is in progress. Select [No, not this time] and click [Next] to continue with the installation.
 - [What do you want the wizard to do?] may appear while the installation is in progress. Select [Install the software automatically (Recommended)] and click [Next] to continue with the installation.
 - If [Hardware Installation] appears on the screen while the installation is in progress, click [Continue Anyway] and continue with the installation.

Adjusting the buffer size

This unit functions as an audio device conforming to the ASIO standards.

- If an application using this unit as the default audio device (DJ software, etc.) is running, quit that application before adjusting the buffer size.

Click Windows [START] menu >[All Programs]>[Pioneer]>[Pioneer CDJ]>[Pioneer CDJ ASIO Settings Utility].

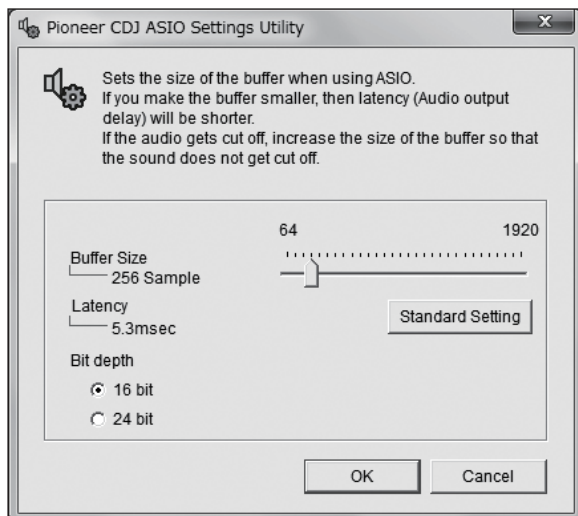

- A sufficiently large buffer size decreases the chance of sound dropout (sound interruption) but increases audio signal transmission delay (latency).

Checking the version of the driver software

Click Windows [START] menu >[All Programs]>[Pioneer]>[Pioneer CDJ]>[Pioneer CDJ Version Display Utility].

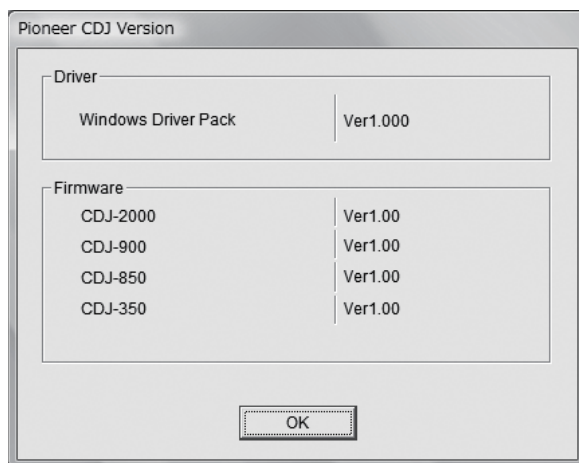

- You can check the firmware version of this unit on the screen.
- The firmware version is not displayed when the CDJ-850 is not connected to the computer or when the CDJ-850 and computer are not properly communicating.

Checking the latest information on the driver software

For the latest information on the driver software for exclusive use with this unit, visit our website shown below.
<http://www.prodjnet.com/support/>

Part names and functions

Control panel

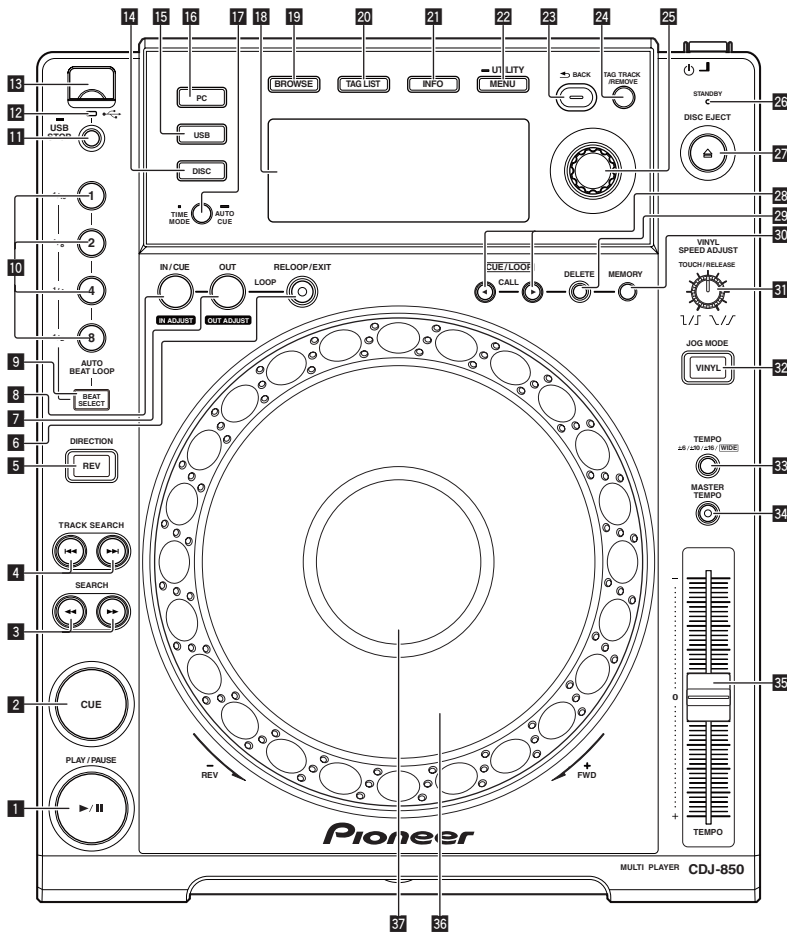

Rear panel

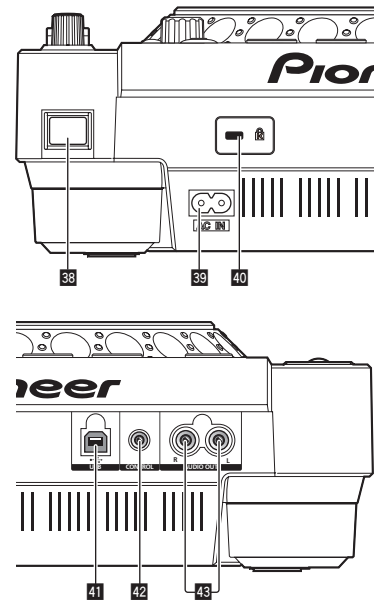

Front panel

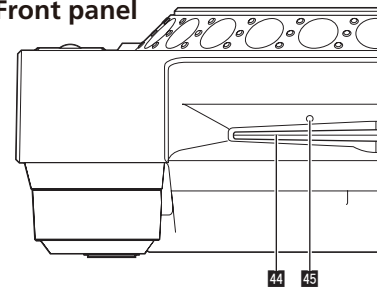

Control panel

1 PLAY/PAUSE ►/II (page 20)

- Use this to play/pause tracks.
- During playback, the indicator lights.
- When in the pause mode, the indicator flashes.

2 CUE (page 20)

- Use this to set and check cue points.
- When a cue point is set, the indicator lights.
- When in the pause mode, the indicator flashes.

3 SEARCH ◀◀, ▶▶ (page 20)

- The track is forwarded/reversed while the button is held in.

4 TRACK SEARCH ◀◀, ▶▶ (page 20)

- Use these to search for the beginnings of tracks.

5 DIRECTION REV (page 20)

- Use this to turn reverse playback on and off.

6 RELOOP/EXIT (page 22)

- Use this to return to loop playback (reloop) or cancel loop playback (loop exit).

7 LOOP OUT (OUT ADJUST) (page 21)

- Use this to set and fine-adjust the loop out point.

8 LOOP IN/CUE (IN ADJUST) (page 21)

- Use this to set and fine-adjust the loop in point.

9 BEAT SELECT (page 22)

- Use this to set the number of beats for auto beat loop playback.

10 AUTO BEAT LOOP (1, 2, 4, 8) (page 22)

- Use these to set the loop automatically according to the track's tempo (auto beat loop).

11 USB STOP (page 17)

- Press for at least 2 seconds before disconnecting the USB device.

12 USB indicator (page 17)

- This flashes when this unit is communicating with the USB device.

13 USB device insertion slot (page 17)

- Load the USB device here.

14 DISC (page 20)

- Press this to play the music files on a CD or CD-ROM.

15 USB (page 20)

- Press this to play the music files on a USB device.

16 PC (page 24)

- Press this to use DJ software.

17 TIME MODE (AUTO CUE) (page 21)

- When pressed once, the main unit display's time display mode (remaining time display or elapsed time display) switches.
- When pressed for over 1 second, auto cue turns on and off.

18 Main unit display (page 15)

19 BROWSE (page 17)

Press this to display the [BROWSE] screen.

20 TAG LIST (page 18)

Press this to display the [TAG LIST] screen.

21 INFO (page 19)

Press this to display the [INFO] screen.

22 MENU (UTILITY) (page 24)

- When pressed once, the menu screen is displayed.
- The [UTILITY] screen is displayed when this is pressed for over 1 second.

23 BACK (page 18)

- Press this once to return to the previous screen.
- Press for over 1 second to move to the top layer.

24 TAG TRACK/REMOVE (page 18)

Use these to add and remove tracks from the tag list.

25 Rotary selector (page 20)

- Turn the rotary selector to select tracks or folders.
- Press the rotary selector to enter.

26 STANDBY indicator (page 25)

This lights when the auto standby function is activated.

27 DISC EJECT ▲ (page 17)

Use this to eject discs.

28 CUE/LOOP CALL ◀/▶ (page 22)

Use these to call out cue and loop points stored on the USB device.

29 DELETE (page 22)

Use this to delete cue and loop points stored on the USB device.

30 MEMORY (page 22)

Use this to store cue and loop points on the USB device.

31 VINYL SPEED ADJUST TOUCH/RELEASE (page 23)

Use this to adjust the speed at which playback slows down and stops when the top of the jog dial is pressed and the speed at which normal playback resumes when the top of the jog dial is released.

32 VINYL (JOG MODE) (page 23)

Use this to switch the jog dial mode.

33 TEMPO ±6, ±10, ±16, WIDE (page 23)

Use this to switch the playing speed adjustment range.

34 MASTER TEMPO (page 23)

Use this to turn the master tempo function on and off.

35 TEMPO (page 23)

Use this to adjust the track playing speed.

36 Jog dial (page 23)

This can be used for such operations as scratching, pitch bending, etc.

37 Jog dial display section (page 15)

Be sure to use the included power cord.

40 Kensington security slot

41 USB (page 16)

Connect to a computer.

42 CONTROL (page 16)

Connect the control cord (included) here.

43 AUDIO OUT L/R (page 16)

Connect the audio cables (included) here.

Front panel

44 Disc insertion slot

45 Disc force eject pin insertion hole

Rear panel

38 ⏻ (power switch)

This switches this unit's power between on and standby.

39 AC IN (page 16)

Connect this to a power outlet.
Connect the power cord after all the connections between devices have been completed.

Main unit display

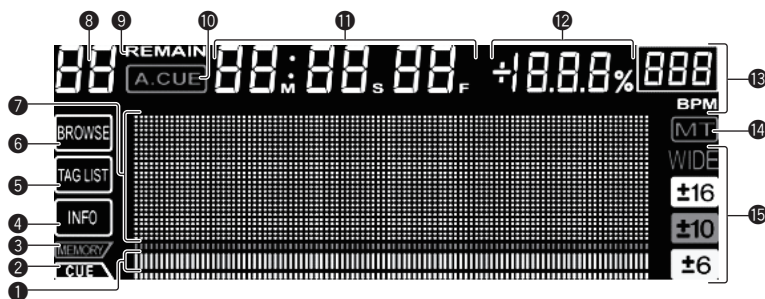

1 Playing address display

The track is displayed as a bar graph. Turns off from the left side when the remaining time is displayed. The entire graph flashes slowly when the remaining track time is under 30 seconds, then flashes quickly when the remaining track time is under 15 seconds.

2 CUE

The positions of currently set cue and loop points are displayed as marks.

3 MEMORY

Cue and loop points recorded on USB devices are displayed as marks.

4 INFO (page 19)

This lights when the [INFO] screen is displayed.

5 TAG LIST (page 18)

This lights when the [TAG LIST] screen is displayed.

6 BROWSE (page 17)

This lights when the [BROWSE] screen is displayed.

7 Information display section

The characters that can be displayed are letters A to Z, numbers 0 to 9 and certain symbols. "?" is displayed for other characters.

8 Track number

This displays the track number. It is not possible to display more than 100 tracks.

9 REMAIN

This lights when the time display is set to the remaining time.

10 A. CUE (page 21)

This lights when auto cue is set.

11 M, S, F (time display)

"M" indicates minutes, "S" seconds, "F" frames. There are 75 frames to a second.

12 % (playing speed display)

This indicates the percentage by which the playing speed is changed.

13 BPM

Displays BPM (Beats Per Minute) of the track currently being played.

14 MT

This lights when the master tempo is set.

15 WIDE, ±16, ±10, ±6

This indicates the range by which the playing speed can be adjusted.

Jog dial display section

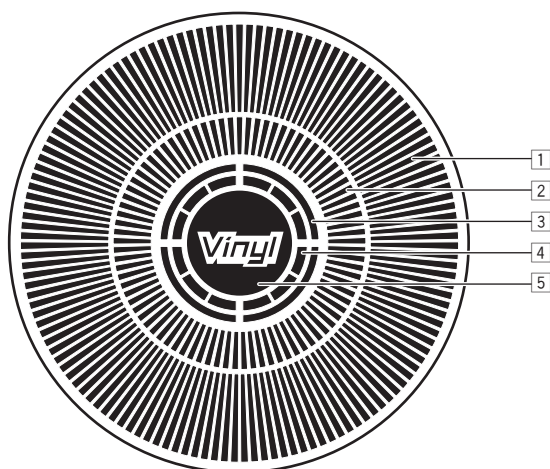

1 Operation display

This indicates the playing position, with one revolution equal to 135 frames. It turns during playback and stops in the pause mode.

2 Cue point display

3 Audio memory status display

This flashes when the audio memory is being written. It stops flashing, remaining lit, when writing is completed. It may not be possible to perform the real time cue operation while the audio memory is being written. The display also flashes when there is not enough memory due to scratch play.

4 Jog touch detection display

When the jog mode is set to VINYL, the top of the jog dial lights when pressed.

5 VINYL

This lights when the jog mode is set to VINYL.

Connections

Be sure to turn off the power and unplug the power cord from the power outlet whenever making or changing connections. Refer to the operating instructions for the component to be connected. Connect the power cord after all the connections between devices have been completed. Be sure to use the included power cord.

Basic style

When connected to a Pioneer DJ mixer using the control cord (included), operations such as starting playback on this unit can be controlled using the DJ mixer's fader (page 24). The fader start function can only be used when connected to a Pioneer DJ mixer.

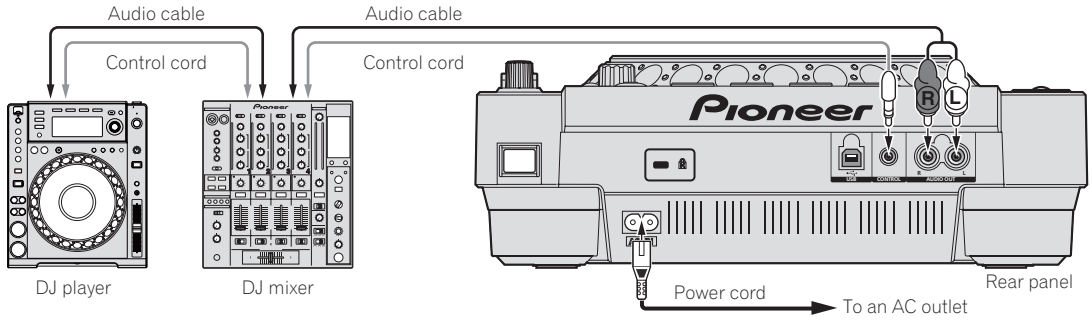

Using the relay play function

Relay playback on two DJ players is possible when the [CONTROL] terminals on this unit and the other Pioneer DJ player are interconnected using a control cord (page 24).

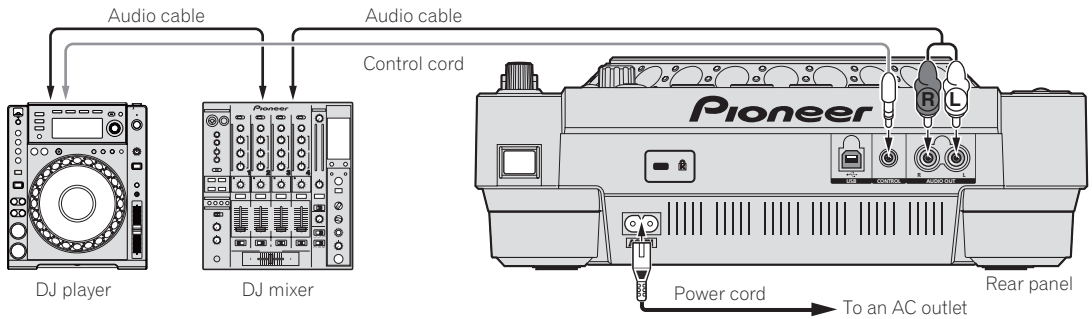

Using DJ software

When connected to a computer by USB cable, the DJ software can be operated with this units (page 24). The sound of music files playing on the computer can be output from this unit (page 11).

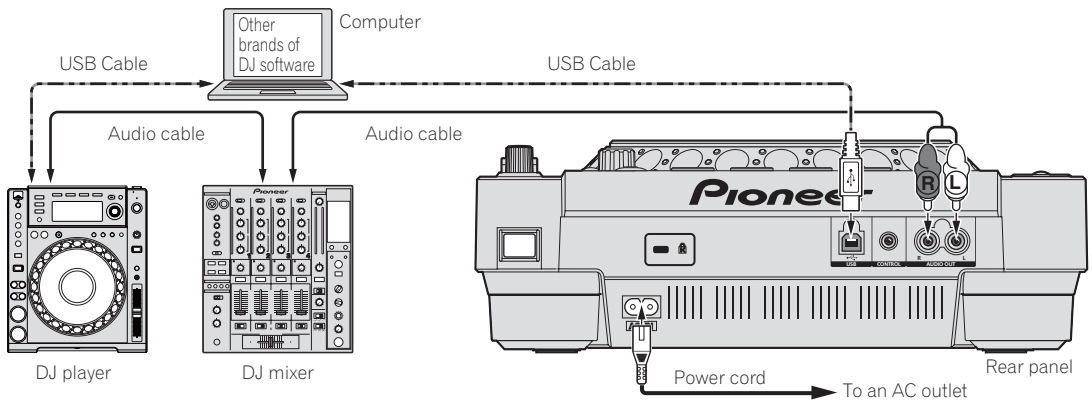

Operations

Setting the source to be played

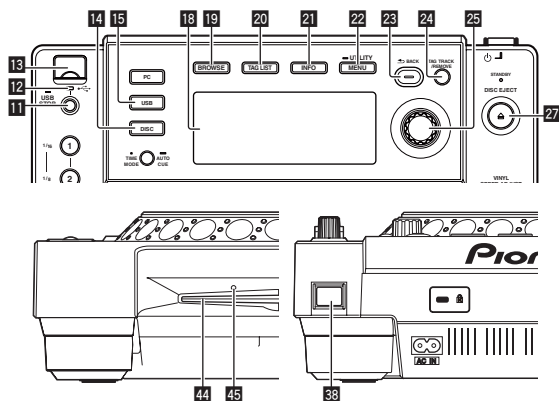

- 1 Press [⏻] 38 to turn this unit's power off, then wait at least 1 minute.

Never forcibly eject a disc directly after turning off the set's power. Doing so is dangerous for the reasons described below.

- The disc will still be spinning when ejected and could hit your fingers, etc., causing injury.
- Also, the disc clamp will rotate in an unstable way, and the disc could get scratched.

- 2 Use the included disc force eject pin. (Do not use anything else.)

The included disc force eject pin is mounted on the CDJ-850's bottom panel. When the pin is inserted all the way into the insertion hole, the disc is ejected 5 mm to 10 mm out of the disc insertion slot. Grasp the disc with your fingers and pull it out.

Loading discs

- Set the disc with the printed side facing up.
- Insert the disc horizontally into the disc insertion slot in the main unit's front panel.
- Do not load more than 1 disc.
- Do not force discs into the set's disc insertion slot when the set's power is off. Doing so could damage the disc or the set.
- When the disc is being drawn in or ejected, do not apply any force to the disc in the direction opposite its movement. Doing so could damage the disc or the set.

- 1 Press [⏻] 38.

Turn on the power of this unit.

- 2 Load the disc in the disc insertion slot 44.

Playback starts.

- When auto cue is turned on, playback starts when [PLAY/PAUSE▶/II] is pressed. For details on the auto cue function, see *Setting auto cue* on page 21.

Ejecting discs

- Press [▲ DISC EJECT] 27.

The disc is ejected from the disc insertion slot.

- If [DISC EJECT ▲] is pressed accidentally, press [PLAY/PAUSE▶/II] immediately to return to the status directly before [DISC EJECT ▲] was pressed. (No sound is output during this time.)

About ejecting discs by force

- If the disc is not ejected when [DISC EJECT ▲] is pressed, the disc can be ejected forcibly by inserting the disc force eject pin into the disc force eject pin insertion hole on the main unit's front panel.
- When forcibly ejecting a disc, be sure to do so following the procedure below.

Loading USB devices

Connect the USB device to the USB device insertion slot 13. The USB indicator lights.

Removing USB devices from the set

- Be sure to follow the procedure below when removing USB devices from the set. Removing a USB device without following this procedure could erase the set's management data and make it impossible to read the USB device.
- When turning the set's power off, be sure to remove the USB device first.

- 1 Press [USB STOP] 11 for at least 2 seconds.

The USB indicator turns off.

- 2 Disconnect the USB device.

Using the [BROWSE] button

When [BROWSE] is pressed, the contents of the medium loaded in this unit are displayed on the information display section.

Browsing libraries and folders

This displays the loaded tracks, sorted in category or tree structure. The display on the information display section differs according to whether or not library information is recorded on the USB device.

- With library information → Library browsing: The music files are displayed by the categories set in rekordbox (album, artist, etc.). The category types can be changed in the **Preferences** (environmental settings) in rekordbox.
- Without library information → Folder browsing: The folders/tracks on the medium are displayed with a tree structure.

Contents recorded on discs cannot be viewed in the library browse mode.



①	List of contents	The contents of the selected medium are displayed.
②	Cursor	Turn the rotary selector to move the cursor up and down.

Searching for tracks

Tracks on the medium loaded in this unit can be searched for using the [SEARCH] categories.

- Tracks recorded on discs cannot be searched.
- Tracks recorded on media for which library browsing is not possible cannot be searched.

1 Press [BROWSE] [19].

2 Turn the rotary selector [25].

Select the [SEARCH] category.

3 Press the rotary selector [25].

The display switches to the character input screen.

4 Use the rotary selector [25] to input characters.

5 Select ← then press the rotary selector [25].

Only the tracks including the character you have input are displayed.

- When more characters are input, only the tracks including the character string you have input are displayed.
- When [BACK] is pressed, the character that was just input is deleted. If no character has been input, the category screen reappears.

Using the jump function

The jump function can be used to instantaneously move to the track, category or folder you want to play.

The jump function includes the two modes below.

- Letter jumping: Use this when the tracks are arranged or sorted in alphabetical order.
- Page jumping: Use this when the tracks are not arranged or sorted in alphabetical order. Turn the rotary selector to jump by page.

❖ In the letter jump mode

1 Press the rotary selector [25] for over 1 second.

The letter jump mode is set. The first letter of the selected track is displayed at the top left.

- The characters displayed in the letter jump mode are letters A to Z, numbers 0 to 9 and certain symbols.

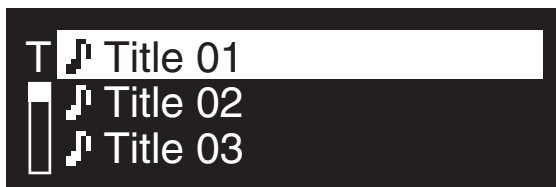

2 Turn the rotary selector [25].

Select the character to which you want to move.

3 Press the rotary selector [25].

The display moves to the category starting with the selected character or symbol.

❖ In the page jump mode

1 Press the rotary selector [25] for over 1 second.

The mode switches to the page jump mode.

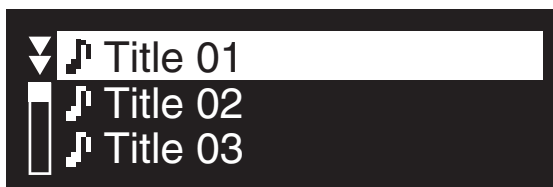

2 Turn the rotary selector [25].

Select the page to which you want to move.

3 Press the rotary selector [25].

The display moves to the selected page.

About the playback history (HISTORY)

When tracks being managed by rekordbox are played, the playback history is recorded in the [HISTORY] category.

A new playback history is created each time the power is turned on/off or a USB device is connected/disconnected.

The maximum number of tracks that can be recorded in a single playback history is 999.

- Tracks are recorded in the playback history if they are played for at least 60 seconds.
- The playback history is recorded on the USB device.
- The playback history is not recorded if there is not enough free space on the USB device or if the USB device is write-protected.
- Playlists can be made based on the playback history using rekordbox. For details, see the rekordbox operating instructions.
- When a playback history is stored as a playlist using rekordbox, the playback history is deleted.

1 Load an SD memory card/USB device in the CDJ-850.

2 Play tracks.

The track being played is recorded and displayed in the playback history.

❖ Deleting the playback history

1 With the contents of the [HISTORY] category displayed, press [MENU (UTILITY)] [22].

The delete menu is displayed.

2 Turn rotary selector [25] then press it.

Select the range to be deleted.

- [DELETE]: The playback history selected with the cursor is deleted.
- [ALL DELETE]: All playback histories are deleted.

3 Turn rotary selector [25] then press it.

- [CANCEL]: The previous screen reappears.
- [OK]: The deletion is performed.

Using the [TAG LIST] button

Up to 1 000 tracks to be played next or tracks selected according to the DJing situation can be collected ahead of time in the tag list.

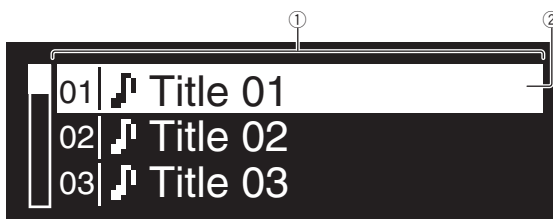

①	List of contents	The contents of the tag list are displayed here.
②	Cursor	Turn the rotary selector to move the cursor up and down.

Adding tracks to the tag list

Set the cursor to the track, then press [TAG TRACK/REMOVE] 24.

✓ is displayed to the left of the track.

- Up to 1 000 tracks can be added to the tag list. If you attempt to add more than 1 000 tracks, a warning message is displayed and the tracks cannot be added.
- When [TAG TRACK/REMOVE] is pressed while the information is displayed after pressing [INFO], the tracks loaded in this unit are added to the tag list.

❖ Adding categories or folders to the tag list

Set the cursor to the category or folder, then press [TAG TRACK/REMOVE] 24.

The category name/folder name flashes, and the tracks in that category/folder are added to the tag list.

- When a category/folder including tracks already added to the tag list is selected and [TAG TRACK/REMOVE] is pressed, only the tracks not already on the tag list are added.
- When folders are added while in the folder browse mode, track names are registered as file names.

❖ Adding playlists to the tag list

Set the cursor to the playlist, then press [TAG TRACK/REMOVE] 24.

The playlist name flashes, and the tracks in that playlist are added to the tag list.

- When a playlist including tracks that have already been added to the tag list is selected and [TAG TRACK/REMOVE] is pressed, only the tracks that were not previously added to the tag list are added.

Removing tracks from the tag list

1 Press [TAG LIST] 20.

The tag list is displayed.

2 Set the cursor to the track you want to remove from the tag list, then press [TAG TRACK/REMOVE] 24 for at least 1 second.

The track is removed from the tag list.

- If a track that has been added to the tag list is removed from the tag list while it is playing, the track is played to the end, then the stop mode is set. The next track is not played.
- When a medium is removed from the CDJ-850, all the tracks recorded on that medium are removed from the tag list.

Removing all the tracks from the tag list

1 Press [TAG LIST] 20.

The tag list is displayed.

2 Press [MENU (UTILITY)] 22.

The [LIST MENU] screen appears.

3 Turn the rotary selector 25.

Select [REMOVE ALL TRACKS].

4 Turn rotary selector 25 then press it.

- [CANCEL]: The previous screen reappears.
- [OK]: The deletion is performed.

Changing the order of the tracks on the tag list

1 Press [TAG LIST] 20.

The tag list is displayed.

2 Set the cursor to the track whose order you want to change, then press [MENU (UTILITY)] 22.

The [LIST MENU] screen appears.

3 Turn the rotary selector 25.

Select [CHANGE ORDER No].

4 Press the rotary selector 25.

The track selected in step 2 flashes.

5 Turn the rotary selector 25.

Select the position to which the track is to be moved.

6 Press the rotary selector 25.

The track order changes.

Transforming the tag list into a playlist

1 Press [TAG LIST] 20.

The tag list is displayed.

2 Press [MENU (UTILITY)] 22.

The [LIST MENU] screen appears.

3 Turn the rotary selector 25.

Select [CREATE PLAYLIST].

4 Press the rotary selector 25.

The [COMPLETE save as NEW PLAYLIST] screen appears and the tag list is transformed into a playlist.

- Only tracks being managed with rekordbox can be transformed into playlists.
The tag list cannot be transformed into a playlist if no library information is recorded on the USB device.

Using the [INFO] button

The details of the tracks loaded in this unit can be checked by pressing [INFO] 21 while a track is playing.



① Track details	The details of the tracks loaded in the DJ player are displayed here.
② WAVE display	The WAVE display is shown here.

Playback

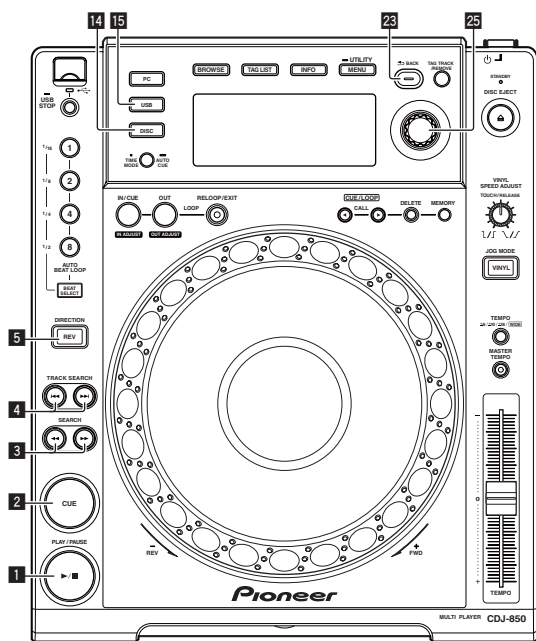

1 Load the source onto this unit.

2 Press either [USB] 15 or [DISC] 14.

This selects the source.

- If tracks are loaded from another source, a warning message is displayed. After checking the message, press the rotary selector to turn the message off and switch the source.

3 Turn the rotary selector 25.

Select the track.

- To move to a lower layer in the folder or category, select the folder then press the rotary selector.
- To return to a higher layer, press [BACK].
- Press [BACK] for more than 1 second to move to the top layer.

4 Press the rotary selector 23.

The track is loaded and playback begins.

- When a disc containing music files recorded with a hierarchical structure is loaded, playback starts from the tracks in the upper-most level.

Pausing

During playback, press [PLAY/PAUSE] 1.

- Playback resumes when [PLAY/PAUSE] is pressed again.

❖ Resuming playback from the position playing just before the disc was ejected (Resume)

After ejecting the disc, immediately reload that same disc into this unit.

- The resume function only works when the same disc is ejected then reloaded before loading another disc.
- The resume function does not work for USB devices.

Forward and reverse scanning

Press [SEARCH] 3.

The disc is forwarded when [SEARCH] is pressed and held in.

The disc is reversed when [SEARCH] is pressed and held in.

Finding the beginnings of tracks (Track Search)

Press [TRACK SEARCH] 4.

Press the [TRACK SEARCH] to move to the beginning of the next track.

When [TRACK SEARCH] is pressed, playback returns to the beginning of the currently playing track. When pressed twice in a row, playback returns to the beginning of the previous track.

- When auto cue is turned on, the set searches for the beginning of the track and pauses there (page 21).

Playing in reverse

Press [DIRECTION REV] 5.

The [DIRECTION REV] indicator lights and the track is played in the reverse direction.

- When the music files are recorded in a folder structure, only tracks within the same category/folder can be played in reverse. Also note that reverse playback may not start immediately.
- The direction in which the playing speed is increased or decreased according to the direction in which the jog dial is turned is reversed.
- When such operations as track searching and loop playback are performed during reverse playback, the audio memory status display on the jog dial display section flashes and scratch play may not be possible.

Setting Cue

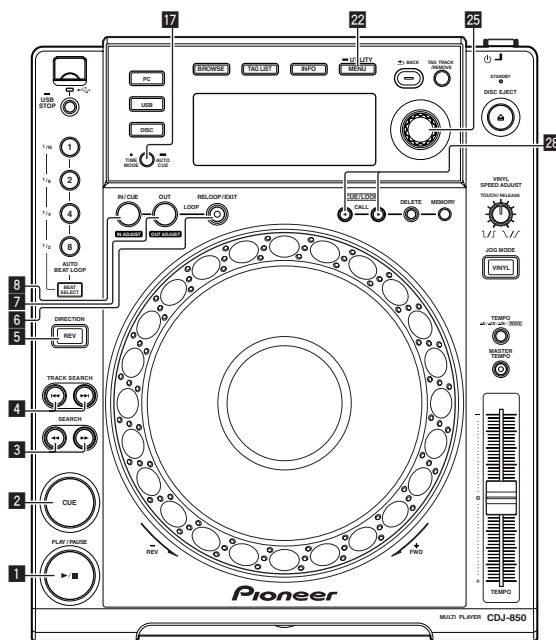

1 During playback, press [PLAY/PAUSE] 1.

Playback is paused.

2 Press [CUE] 2.

The point at which the track is paused is set as the cue point.

The [PLAY/PAUSE] indicator flashes and the [CUE] indicator lights. No sound is output at this time.

- When a new cue point is set, the previously set cue point is canceled.

Adjusting the cue point position

- 1 While paused at the cue point, press [SEARCH ◀▶] **3**.

The [PLAY/PAUSE▶/II] and [CUE] indicators flash.

- 2 Press [SEARCH ◀▶, ▶▶] **3**.

The cue point can be fine-adjusted in units of single frames.

- The same operation is possible using the jog dial.

- 3 Press [CUE] **2**.

The position at which the button was pressed is set as the new cue point.

- When a new cue point is set, the previously set cue point is canceled.

Returning to Cue Point (Back Cue)

- During playback, press [CUE] **2**.

The set immediately returns to the currently set cue point and pauses.

- When [PLAY/PAUSE▶/II] is pressed, playback starts from the cue point.

Checking Cue Point (Cue Point Sampler)

- After returning to the cue point, press and hold in [CUE] **2**.

Playback starts from the set cue point. Playback continues while the button is held in.

Setting Cue Point during playback (Real Time Cue)

- During playback, press [LOOP IN/CUE (IN ADJUST)] **8**.

The point at which the button was pressed is set as the cue point.

Setting auto cue

When a track is loaded or the track search operation is performed, the silent section at the beginning of the track is skipped and the cue point is automatically set at the point immediately before the sound starts.

- Press [TIME MODE (AUTO CUE)] **17** for over 1 seconds.

Auto cue is set to on.

[A. CUE] lights on the main unit display.

- When [TIME MODE (AUTO CUE)] is pressed again for at least 1 second, auto cue is set to off.
- The auto cue level setting remains in the memory, even when the power is turned off.

Changing the auto cue level

The acoustic pressure level identified as a silent section with the auto cue function can be selected from eight levels.

-36 dB, -42 dB, -48 dB, -54 dB, -60 dB, -66 dB, -72 dB and -78 dB

- The auto cue level setting remains in the memory, even when the power is turned off.
- The auto cue level can be changed using one of the procedures described below.

❖ Using the [MENU (UTILITY)] **22** button

- 1 Press [MENU (UTILITY)] **22** for over 1 second.

The [UTILITY] screen is displayed.

- 2 Turn rotary selector **25** then press it.

Select [A. CUE LEVEL].

- 3 Turn rotary selector **25** then press it.

The auto cue level setting changes.

❖ Using the [TIME MODE (AUTO CUE)] **17** button

- 1 Press [TIME MODE (AUTO CUE)] **17** for over 5 seconds.

The auto cue level setting changing mode is set.

The current auto cue level is shown on the main unit display.

- 2 Press [CUE/LOOP CALL◀/▶] **28**.

The auto cue level setting changes.

Setting Loop

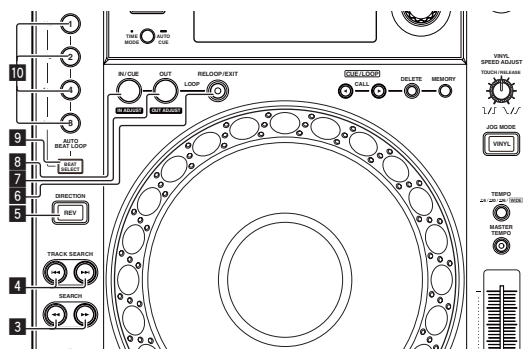

- 1 During playback, press [LOOP IN/CUE (IN ADJUST)] **8**.

Loop In Point is set.

- This operation is not necessary if you have already set a Cue Point as a Loop In Point.

- 2 Press [LOOP OUT (OUT ADJUST)] **7**.

The loop out point is set, and loop playback begins.

Fine-adjusting the loop in point (loop in adjust)

- 1 During loop playback, press [LOOP IN/CUE (IN ADJUST)] **8**.

[LOOP IN/CUE (IN ADJUST)] switches to a fast flashing and [LOOP OUT (OUT ADJUST)] turns off.

The loop in point's time is displayed on the main unit display.

- 2 Press [SEARCH ◀▶, ▶▶] **3**.

Loop points can be fine-adjusted in units of single frames.

- The same operation is possible using the jog dial.
- The loop in point can be adjusted by ± 30 frames and must be in front of the loop out point.

- 3 Press [LOOP IN/CUE (IN ADJUST)] **8**.

- Normal loop playback resumes.
- Normal loop playback also resumes if no operation is performed for over 10 seconds.
- When playing music files, the loop in point can only be adjusted within the same track.

Fine-adjusting the loop out point (loop out adjust)

- 1 During loop playback, press [LOOP OUT (OUT ADJUST)] **7**.

[LOOP OUT (OUT ADJUST)] starts flashing quickly and [LOOP IN/CUE (IN ADJUST)] turns off.

The loop out point's time is displayed on the main unit display.

2 Press [SEARCH ◀▶] 3.

The loop out point can be adjusted in units of single frames.

- The same operation is possible using the jog dial.
- The loop out point adjustment range is anywhere after the loop in point.

3 Press [LOOP OUT (OUT ADJUST)] 7.

Loop playback resumes.

- Loop playback also resumes if no operation is performed for over 10 seconds.

Canceling Loop playback (Loop Exit)

During loop playback, press [RELOOP/EXIT] 6.

Playback continues beyond the Loop Out Point without returning to the Loop In Point.

Returning to Loop playback (Reloop)

After canceling loop playback, press [RELOOP/EXIT] 6 during playback.

The track returns to the previously set loop in point and loop playback begins.

Setting the loop automatically based on the track's tempo (Auto Beat Loop)

1 Press [BEAT SELECT] 9.

Set the number of beats for loop playback. This operation is not necessary when selecting 1-beat, 2-beat, 4-beat or 8-beat loop playback.

- When 1-beat, 2-beat, 4-beat or 8-beat loop playback is selected, the indicator lights.
- When 1/16-beat, 1/8-beat, 1/4-beat or 1/2-beat loop playback is selected, the indicator is turned off.

2 In the play or pause mode, press one of the [AUTO BEAT LOOP] buttons 10 (1, 2, 4 or 8) at the position at which you want to set the loop.

The pressed button flashes, the loop out point is set automatically according to the track's tempo (BPM) and the number of beats set in step 1, and loop playback begins.

- When one of the [AUTO BEAT LOOP] buttons (1, 2, 4 or 8) is pressed again during auto beat looping, the loop out point is automatically reset according to the track's tempo (BPM) and the number of beats of the button that was pressed, and loop playback begins.

Storing cue and loop points

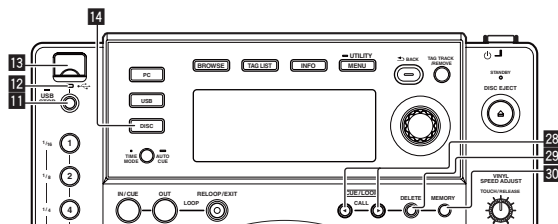

1 Load an SD memory card/USB device in the CDJ-850.

2 Set Cue Point or Loop Point.

3 Press [MEMORY] 30.

[MEMORY] appears on the main unit display. The stored cue point are displayed on the playing address display. The point information is recorded on the USB device.

- To store loop points, press [MEMORY] during loop playback. The stored loop points appear on the playing address display.

Calling out saved cue or loop points

1 Load an SD memory card/USB device in the CDJ-850.

2 Load the track whose cue or loop points you want to call out.

Cue and loop points are displayed as marks on the playing address display.

3 Press [CUE/LOOP CALL◀/▶] 28.

The playback position is moved to the selected point and paused.

- When multiple points are recorded, the point moves each time the button is pressed.

Deleting cue or loop points individually

1 Load an SD memory card/USB device in the CDJ-850.

2 Load the track containing the cue point or loop points you want to delete.

Cue and loop points are displayed as marks on the playing address display.

3 Press [CUE/LOOP CALL◀/▶] 28.

The playback position is moved to the selected point and paused.

- When multiple points are recorded, the point moves each time the button is pressed.

4 Press [DELETE] 29.

[DELETE] appears on the main unit display and the selected point information is deleted.

Deleting all cue and loop points for a disc

1 Load a disc in the CDJ-850.

2 Load an SD memory card/USB device in the CDJ-850.

Cue and loop points are displayed as marks on the playing address display.

3 Press [DISC] 14.

4 Press [DELETE] 29 for at least 5 seconds.

[DISC CUE/LOOP DATA-DELETE? PUSH MEMORY] appears on the main unit display.

5 Press [MEMORY] 30.

All cue and loop points for the disc currently loaded in the CDJ-850 are deleted.

- The deletion mode is canceled when any button other than [MEMORY] is pressed.

Deleting all disc information recorded on the USB device

1 Press [DISC] 14.

2 With no disc loaded in this unit, press [DELETE] 29 for over 5 seconds.

[DISC CUE/LOOP DATA-DELETE ALL? PUSH MEMORY] appears on the main unit display.

3 Press [MEMORY] 30.

All the disc information recorded on the USB device is deleted.

- The deletion mode is canceled when any button other than [MEMORY] is pressed.

Adjusting the playing speed (Tempo control)

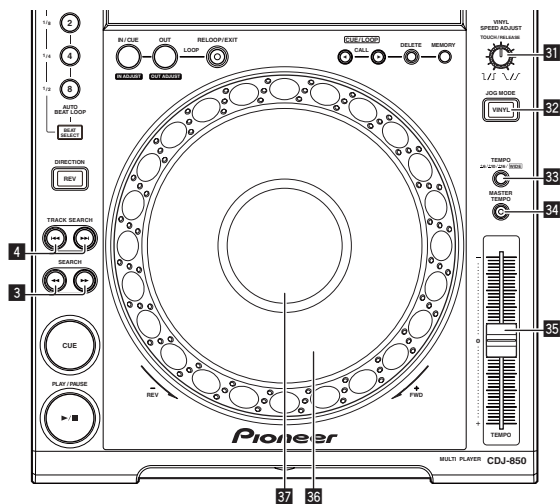

Move [TEMPO] 35 forward and backward.

The playing speed increases when the slider is moved to the [+] side (towards you), decreases when the slider is moved to the [-] side (away from you).

The percentage by which the playing speed is changed is displayed at [%] on the main unit display.

Selecting the playing speed adjustment range

Press [TEMPO ±6, ±10, ±16, WIDE] 33.

The playing speed adjustment range switches each time the button is pressed.

[WIDE, ±16, ±10, ±6] lights on the main unit display.

- The speed can be adjusted in units of 0.02 % at [±6] %, in units of 0.05 % at [±10] %, in units of 0.05 % at [±16] %, and in units of 0.5 % at [WIDE].
- The [WIDE] adjustment range is ±100 %. When set to -100 %, playback stops.
- [WIDE] can only be selected when playing music CDs (CD-DA).

Adjusting the playing speed without changing the pitch (Master Tempo)

Press [MASTER TEMPO] 34.

The [MASTER TEMPO] indicator lights. The pitch does not change even when the playing speed is changed with the [TEMPO] slider.

- The sound is digitally processed, so the sound quality changes.

Operating the jog dial

- The top of the jog dial has an embedded switch. Do not place objects on the jog dial or subject it to strong forces.
- Water or other liquids getting into the set will lead to malfunction.

Switching the jog dial mode

Press [VINYL (JOG MODE)] 32.

The mode switches between VINYL and CDJ each time the button is pressed.

The indicator lights when the VINYL mode is selected.

- VINYL mode: When the top of the jog dial is pressed during playback, playback stops, and when the jog dial is spun at this time sound is produced according to the direction in which the jog dial is spun.
- CDJ mode: Playback does not stop even when the top of the jog dial is pressed. Such operations as scratching cannot be performed.

Scratch

1 Press [VINYL (JOG MODE)] 32.

Set the jog mode to VINYL.

2 During playback, press the top of the jog dial 36.

Playback stops.

3 Spin the jog dial 36 in the direction you want to play and at the desired speed.

The sound is played according to the direction and speed at which the jog dial is spun by spinning the top of the jog dial while pressing it.

4 Release your hand from the top of the jog dial 36.

Normal playback resumes.

- ❖ **Adjusting the speed at which playback slows then stops when the top of the jog dial is pressed and the speed at which playback returns to normal when the top of the jog dial is released.**

Turn [VINYL SPEED ADJUST TOUCH/RELEASE] 31.

The speed increases when turned clockwise, decreases when turned counterclockwise.

- When the jog mode set to the VINYL mode, the speed at which playback starts and stops when [PLAY/PAUSE▶/||] is pressed changes simultaneously.

Pitch bend

During playback, spin the outer section without touching the top of the jog dial 36.

The playing speed increases when spun clockwise, decreases when spun counterclockwise. When spinning is stopped, playback returns to the normal speed.

- When the jog mode is set to the CDJ mode, the same operation can be performed by spinning the top of the jog dial.

Frame search

Spin the jog dial 36 while in the pause mode.

The pause position can be moved in units of single frames.

- The position is moved in the direction of playback when the jog dial is spun clockwise, in the reverse direction when the jog dial is spun counterclockwise.

Super fast search

Spin the jog dial 36 while pressing [SEARCH ◀◀, ▶▶] 3.

The track is fast-forwarded/fast-reversed in the direction in which the jog dial is spun.

- This function is canceled when [SEARCH ◀▶] is released.
- When you stop the jog dial from spinning, normal playback resumes.
- The fast-forward/fast-reverse speed can be adjusted according to the speed at which the jog dial is spun.

Super fast track search

Turn the jog dial **26** while pressing [TRACK SEARCH ◀▶] **4**.

The track is advanced at high speed in the direction in which the jog dial was turned.

Operations in combination with a DJ mixer

Also refer to the DJ mixer's operating instructions.

Starting playback using a DJ mixer's fader (Fader Start)

1 Connect the CDJ-850 with a Pioneer DJ mixer using the included control cord.

For instructions on connecting, see *Basic style* on page 16.

2 Turn on the fader start function from the DJ mixer.

3 Set the cue.

4 Move the DJ mixer's channel fader or cross fader.

This unit's pause mode is canceled and the track is played instantaneously.

- When the channel fader or cross fader is set back to its original position, playback cues back to the set cue point and the pause mode is set (Back Cue).

Relay play on two DJ players

1 Connect the CDJ-850 and a DJ mixer.

For instructions on connecting, see *Using the relay play function* on page 16.

2 Set the DJ mixer's cross fader to the center position.

3 Turn auto cue on for both DJ players.

The DJ players' auto cue indicators light.

4 Start playback on this unit.

When playback of the first track on this unit finishes, playback automatically begins on the other DJ player. This unit cues at the beginning of the next track and is set to the pause mode. This operation is repeated for relay play on the two DJ players.

- The medium can be changed and the cue point set on the DJ player that is in standby.
- The fader start function does not work during relay play.
- Relay play may not be possible if the two DJ players are not connected to the same DJ mixer.
- If the power of the currently playing DJ player is turned off, playback may start on the other DJ player.

Using the DJ software

The CDJ-850 also outputs the operating data for the buttons and dials in MIDI format. If you connect a computer with a built-in MIDI-compatible DJ software via a USB cable, you can operate the DJ software on this unit. The sound of music files being played on the computer can also be output from the CDJ-850.

To use this unit as an audio device, install the driver software on the computer beforehand (page 11). This unit must also be selected in the DJ software's audio output device settings. For details, see your DJ software's operating instructions.

1 Connect the USB port on this unit to your computer.

For instructions on connecting, see *Using DJ software* on page 16.

2 Press [PC] **16.**

The [CONNECTED] screen appears on the main unit display.

- If tracks are loaded from another source, a warning message is displayed. After checking the message, press the rotary selector to turn the message off and switch the source.

3 Start the DJ software.

Communication with the DJ software starts.

The DJ software can be operated using this unit's buttons and controls.

- It may not be possible to use some buttons to operate the DJ software.
- For messages output by the CDJ-850, see *List of MIDI Messages* on page 27.

Changing the MIDI channel setting

1 Press [MENU (UTILITY)] **22 for over 1 second.**

The [UTILITY] screen is displayed.

2 Turn rotary selector **25 then press it.**

Select [MIDI CH.].

3 Turn rotary selector **25 then press it.**

Select the MIDI channel and change the setting. A setting from 1 – 16 can be selected.

4 Press the rotary selector **25.**

The changed MIDI channel settings are stored.

- To close the [UTILITY] screen, press [MENU (UTILITY)] or [BACK].

Changing the settings

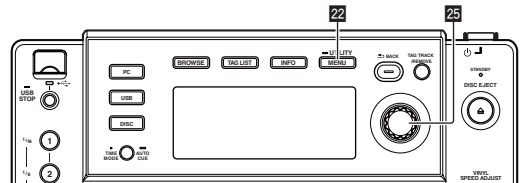

1 Press [MENU (UTILITY)] **22 for over 1 second.**

The [UTILITY] screen is displayed.

2 Use the rotary selector **25 to change the setting.**

- Press [BACK] to return to the previous screen.

3 Press the rotary selector **25.**

The changed settings are stored.

- To close the [UTILITY] screen, press [MENU (UTILITY)] or [BACK].

Setting preferences

Options settings	Selection items	Descriptions
A. CUE LEVEL	-36 dB/-42 dB/-48 dB/ -54 dB/-60 dB*/-66 dB/ -72 dB/-78 dB	For details, see <i>Changing the auto cue level</i> on page 21.
MIDI CH	1* to 16	—

Options settings	Selection items	Descriptions
LIBRARY CREATOR	LIBRARY*/FOLDER	Sets the browsing method for media on which Pioneer MEP-7000 libraries are recorded.
HISTORY NAME	—	For details, see <i>Setting [HISTORY NAME]</i> on page 25.
TAGLIST NAME	—	For details, see <i>Setting [TAGLIST NAME]</i> on page 25.
AUTO STANDBY	ON*/OFF	For details, see <i>Setting the auto standby mode</i> on page 25.
Ver.	—	Displays the CDJ-850's software version.

*: Setting upon purchase

❖ Setting the auto standby mode

1 Turn rotary selector **25** then press it.

Select [AUTO STANDBY].

2 Turn rotary selector **25** then press it.

Select [ON].

When the auto standby function is turned on, the standby mode is set automatically if no operation is performed on this unit for 4 hours.

- When the CDJ-850 is operated, the standby mode is canceled.
- This unit is shipped with the auto standby function turned on.
If you do not want to use the auto standby function, set [AUTO STANDBY] to [OFF].

❖ Setting [HISTORY NAME]

The names of playback histories recorded on USB devices can be set in advance.

1 Turn rotary selector **25** then press it.

Select [HISTORY NAME].

2 Use the rotary selector **25** to input characters.

3 Press the rotary selector **25**.

The [HISTORY NAME] setting is changed.

- If [HISTORY NAME] is not set, numbers are added sequentially after [HISTORY].
- Up to 32 characters (total of one-byte letters and symbols) can be set for [HISTORY NAME].

❖ Setting [TAGLIST NAME]

The name of [TAGLIST] recorded on USB devices can be set in advance.

1 Turn rotary selector **25** then press it.

Select [TAGLIST NAME].

2 Use the rotary selector **25** to input characters.

3 Press the rotary selector **25**.

The [TAGLIST NAME] setting is changed.

- If [TAGLIST NAME] is not set, numbers are added in order after [TAGLIST].
- Up to 32 characters (total of one-byte letters and symbols) can be set for [TAGLIST NAME].

Additional information

Troubleshooting

- Incorrect operation is often mistaken for trouble or malfunction. If you think that there is something wrong with this component, check the points below. Sometimes the trouble may lie in another component. Inspect the other components and electrical appliances being used. If the trouble cannot be rectified after checking the items below, ask your nearest Pioneer authorized service center or your dealer to carry out repair work.
- This unit may not operate properly due to static electricity or other external influences. In this case, proper operation may be restored by turning the power off, waiting 1 minute, then turning the power back on.
- Non-finalized (partial discs) CD-R/-RW cannot be played on the CDJ-850.
- Irregularly shaped discs other than standard 12 cm discs cannot be played on the CDJ-850 (doing so will lead to damage or accidents).
- The BPM measured by the CDJ-850 may differ from the BPM indicated on the disc or that of a Pioneer DJ mixer, etc. This is due to the different methods used for measuring the BPM, and is not a malfunction.

Problem	Check	Remedy
Disc cannot be ejected.	—	If the [DISC EJECT ▲] button does not work, insert the pin in the disc force eject pin insertion hole to eject the disc. (page 17)
Playback does not start when disc is loaded.	Is the disc or file playable?	See <i>About discs</i> on page 7 or <i>Playable music file formats</i> on page 8.
	Is the auto cue function activated?	Press [TIME MODE (AUTO CUE)] for at least 1 second to cancel the auto cue function. (page 21)
File cannot be played.	Is the file copyright-protected (by DRM)?	Copyright-protected files cannot be played.
No sound is produced, or sound is distorted or noisy.	Are you operating the connected DJ mixer properly?	Check the operation of the DJ mixer.
	Is the CDJ-850 placed near a TV?	Turn the TV's power off, or install the CDJ-850 and TV away from one another.
Loud noise is produced or playback stops when a certain disc is played.	Is the disc scratched?	Scratched discs may not play.
	Is the disc dirty?	Wipe the dirt off the disc. (page 28)
File information is not properly displayed.	Is the information recorded in a language not supported by the CDJ-850?	When creating files using DJ software, etc., record the information in a language supported by the CDJ-850.
Track search operation takes too long.	Is the auto cue function activated?	Track searching may take some time when there are long silent sections between tracks.
	—	If track searching is not possible within 10 seconds, a cue point is set at the beginning of the track.
Back cue function does not work.	Is a cue point set?	Set a cue point. (page 20)
Loop play function does not work.	Is a cue point set?	Set a cue point. (page 20)
Settings are not stored in the memory.	Has the power been turned off directly after changing the setting?	After changing settings, wait at least 10 seconds before turning the power off.
USB device is not recognized.	Is the USB device properly connected?	Connect the device securely (all the way in).
	Is the USB device connected via a USB hub?	USB hubs cannot be used.
	Is the USB device supported by the CDJ-850?	This player only supports USB mass storage class devices. This player supports portable flash memory and digital audio playback devices.
	Is the file format supported by the CDJ-850?	Check the file format of the connected USB device. For the file formats supported by the CDJ-850, see <i>About USB devices</i> on page 8.
	Are you using a USB device (such as a bus power-driven hard disk) whose current is higher than this unit's rated current (500 mA)?	Use a USB device within this unit's rated current (such as a hard disk driven by an AC adapter or other external power supply).
Cue or loop points of tracks recorded on USB devices are not stored in the memory.	—	Turn the power off, wait 1 minute, then turn the power back on.
	Is there sufficient free space on the USB device?	A maximum of 100 cue and loop points per disc can be recorded on USB devices (10 per track for media other than discs). If you attempt to record more points than the limit, [POINT FULL] is displayed and the points cannot be recorded.
	Is the USB device write-protected?	Set the USB device so that files can be written on it. Set the USB device's write-protect switch to the off position.
Cue or loop points of tracks recorded on USB devices are not displayed.	Has the USB device been properly removed?	Points may not be displayed if the SD memory card/USB device is removed without performing the proper stopping procedure or if the CDJ-850's power is turned off.
Time is required to read USB devices (flash memory drives and hard discs).	Is there a large number of folders or files recorded on the USB device?	When there are many folders or files, some time may be required for loading.
	Are files other than music files stored on the USB device?	When files other than music files are stored in folders, time is required to read them as well. Do not store files or folders other than music files on the USB device.
The playing address display is not displayed in the remaining time mode.	—	When playing files recorded in VBR, it may happen that the set cannot detect the length of the track immediately and that some time is required for the playing address display to appear.

Problem	Check	Remedy
Library browsing is not possible.	Is a medium on which library information is recorded loaded?	The library browse mode is only set when media on which library information is recorded are loaded. When a medium on which no library information is recorded is loaded, the folder browse mode is set.
	Is the USB device write-protected?	Set the USB device so that files can be written on it. Set the USB device's write-protect switch to the off position.
Nothing is displayed.	Is the auto standby function activated?	This unit is shipped with the auto standby function turned on. If you do not want to use the auto standby function, set [AUTO STANDBY] to [OFF] . (page 25)

Error messages

When the CDJ-850 cannot operate normally, an error code appears on the display. Take the necessary measures, referring to the table below. If an error code not indicated on the table below is displayed or if the same error code appears after the indicated action has been taken, contact your store of purchase or nearby Pioneer service station.

Error code	Error type	Description of error	Cause and action
E-7201	TOC READ ERROR	TOC data cannot be read.	<ul style="list-style-type: none"> Disc is cracked. → Replace the disc. Disc is dirty. → Clean the disc. If operation is normal with other discs, the problem is with that disc.
E-8301 E-8302 E-8303	PLAYER ERROR	Disc that cannot be played normally is loaded.	
E-8304	DECODE ERROR	Music files that cannot be played normally are loaded.	Format is wrong. → Replace with music files in the proper format.
E-8305	DATA FORMAT ERROR		
E-8306	NO FILE	Track recorded in the library, playlist, etc., has been deleted from the USB device and cannot be played.	Do not delete that track from the USB device.
E-9101	MECHANICAL TIME OUT	Mechanical operation has not stopped within specified time.	There is a foreign object in the disc insertion slot. → Remove the foreign object.

List of MIDI Messages

SW Name	SW Type	MIDI Messages		Notes
		MSB		
Jog dial (scratch)	—	Bn	10 dd	A linear value corresponding to the speed, from stop to 4X: 64 for stop, 65 (0.06X) – 127 (4X) in the forward direction, 63 (0.06X) – 0 (4X) in the reverse direction.
TEMPO	VR	Bn	1D dd	0 – 127, 0 on the – side, 127 on the + side
TOUCH/RELEASE	VR	Bn	1E dd	0 – 127, 0 (min.) on the left side, 127 (max.) on the right side
Jog dial (spin outer section)	—	Bn	30 dd	A linear value corresponding to the speed from 0.5X to 4X: 64 when stopped (under 0.49X), 65 (0.5X) to 127 (4X) in the forward direction, 63 (0.5X) to 0 (4X) in the reverse direction.
SELECT PUSH (turn)	General Purpose Controller	Bn	4F dd	98 – 127, 1 – 30 Difference of count from previous time is sent ($\pm 1 - \pm 30$) When over ± 30 , set at ± 30
PLAY/PAUSE ►/II	SW	9n	00 dd	OFF=0, ON=127
CUE	SW	9n	01 dd	OFF=0, ON=127
SEARCH ►►	SW	9n	02 dd	OFF=0, ON=127
SEARCH ◄◄	SW	9n	03 dd	OFF=0, ON=127
TRACK SEARCH ►►I	SW	9n	04 dd	OFF=0, ON=127
TRACK SEARCH I◄◄	SW	9n	05 dd	OFF=0, ON=127
LOOP IN/CUE (IN ADJUST)	SW	9n	06 dd	OFF=0, ON=127

SW Name	SW Type	MIDI Messages		Notes
		MSB		
LOOP OUT (OUT ADJUST)	SW	9n	07 dd	OFF=0, ON=127
RELOOP/EXIT	SW	9n	08 dd	OFF=0, ON=127
MEMORY	SW	9n	0A dd	OFF=0, ON=127
CUE/LOOP CALL ►	SW	9n	0B dd	OFF=0, ON=127
CUE/LOOP CALL ◄	SW	9n	0C dd	OFF=0, ON=127
DELETE	SW	9n	0D dd	OFF=0, ON=127
TIME MODE (AUTO CUE)	SW	9n	0E dd	OFF=0, ON=127
TEMPO $\pm 6, \pm 10, \pm 16, \text{ WIDE}$	SW	9n	10 dd	OFF=0, ON=127
MASTER TEMPO	SW	9n	11 dd	OFF=0, ON=127
VINYL	SW	9n	12 dd	OFF=0, ON=127
Jog dial (press top)	SW	9n	20 dd	OFF=0, ON=127
DIRECTION REV	SW	9n	21 dd	OFF=0, ON=127
AUTO BEAT LOOP 1	SW	9n	28 dd	OFF=0, ON=127
AUTO BEAT LOOP 2	SW	9n	29 dd	OFF=0, ON=127
AUTO BEAT LOOP 4	SW	9n	2A dd	OFF=0, ON=127
AUTO BEAT LOOP 8	SW	9n	2B dd	OFF=0, ON=127
BEAT SELECT	SW	9n	2D dd	OFF=0, ON=127
DISC EJECT ▲	SW	9n	2F dd	OFF=0, ON=127
TAG TRACK/REMOVE	SW	9n	30 dd	OFF=0, ON=127
BACK	SW	9n	32 dd	OFF=0, ON=127
SELECT PUSH (press)	SW	9n	33 dd	OFF=0, ON=127
BROWSE	SW	9n	36 dd	OFF=0, ON=127
TAGLIST	SW	9n	37 dd	OFF=0, ON=127
INFO	SW	9n	38 dd	OFF=0, ON=127

SW Name	SW Type	MIDI Messages			Notes
		MSB			
MENU (UTILITY)	SW	9n	3F	dd	OFF=0, ON=127
n is the channel number.					

List of icons displayed on the main unit display section

	Genre		Rating
	Artist		Time
	Album		Registered in tag list
	Track/file name		Playback is not possible
	Playlist		Playing
	Remixer		Played
	Original artist		Label
	Playback history		Folder
	WAIT		

Cautions on use

About condensation

Water droplets (condensation) may form inside the unit (on operating parts and lenses) in the winter, for example, if the unit is moved from a cold place into a warm room or if the temperature in the room in which the unit is installed rises suddenly (through heating, etc.). The unit will not operate properly and will not be playable with condensation inside. Let the unit stand for 1 to 2 hours at room temperature (though this time depends on the conditions of the condensation) without turning on the power. The water droplets will evaporate and the unit will become playable. Condensation can occur in the summer as well if the unit is exposed to the direct wind from an air-conditioner, etc. If this happens, move the unit to a different location.

Cleaning the lens

The player's lens should not become dirty in normal use, but if for some reason it should malfunction due to dust or dirt, consult your nearest Pioneer authorized service center. Although lens cleaners for players are commercially available, we advise against using them since some may damage the lens.

Handling discs

Storing

- Always place discs in their cases and store them vertically, avoiding hot, humid places, places exposed to direct sunlight and extremely cold places.
- Be sure to read the cautions included with the disc.

Cleaning discs

- Discs may not play if there are fingerprints or dust on them. In this case, use a cleaning cloth, etc., to gently wipe the disc from the inside towards the outside. Do not use dirty cleaning cloths.



- Do not use benzene, thinner or other volatile chemicals. Also do not use record spray or antistatic agents.
- For tough dirt, apply some water to a soft cloth, wring out thoroughly, wipe off the dirt, then wipe off the moisture with a dry cloth.
- Do not use damaged (cracked or warped) discs.
- Do not let the signal surface of discs get scratched or dirty.
- Do not place two discs in the disc tray, one on top of the other.
- Do not attach pieces of paper or stickers to discs. Doing so could warp discs, making it impossible to play them. Also note that rental discs often have labels attached to them, and the label's glue may have oozed out. Check that there is no glue around the edges of such labels before using rented discs.

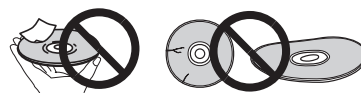

About specially shaped discs

Specially shaped discs (heart-shaped, hexagonal, etc.) cannot be played on this player. Do not attempt to play such discs, as they could damage the player.



About condensation on discs

Water droplets (condensation) may form on the surface of discs if they are moved from a cold place (particularly in winter) into a warm room. Discs may not play normally if there is condensation on them. Carefully wipe the water droplets off the surface of the disc before loading it.

Disclaimer

- Pioneer and rekordbox are trademarks or registered trademarks of the Pioneer Corporation.
 - Microsoft®, Windows Vista®, Windows® and Internet Explorer® are registered trademarks or trademarks in the United States and other countries of the Microsoft Corporation of the United States.
 - Apple, Macintosh, Mac OS, Safari, iTunes and Finder are registered trademarks of Apple Inc. in the United States and other countries.
 - Pentium is a registered trademark of Intel Corporation.
 - Adobe and Reader are either registered trademarks or trademarks of Adobe Systems Incorporated in the United States and/or other countries.
 - ASIO is a trademark of Steinberg Media Technologies GmbH.
- The names of companies and products mentioned herein are the trademarks of their respective owners.

This product has been licensed for nonprofit use. This product has not been licensed for commercial purposes (for profit-making use), such as broadcasting (terrestrial, satellite, cable or other types of broadcasting), streaming on the Internet, Intranet (a corporate network) or other types of networks or distributing of electronic information (online digital music distribution service). You need to acquire the corresponding licenses for such uses. For details, visit <http://www.mp3licensing.com>.

Cautions on copyrights

rekordbox restricts playback and duplication of copyright-protected music contents.

- When coded data, etc., for protecting the copyright is embedded in the music contents, it may not be possible to operate the program normally.
- When rekordbox detects that coded data, etc., for protecting the copyright is embedded in the music contents, processing (playback, reading, etc.) may stop.

Recordings you have made are for your personal enjoyment and according to copyright laws may not be used without the consent of the copyright holder.

- Music recorded from CDs, etc., is protected by the copyright laws of individual countries and by international treaties. It is the full responsibility of the person who has recorded the music to ensure that it is used legally.
- When handling music downloaded from the Internet, etc., it is the full responsibility of the person who has downloaded the music to ensure that it is used in accordance with the contract concluded with the download site.

Using the support site

Before making an inquiry about rekordbox operations and technical support, refer to the operating instructions for rekordbox and check the FAQs published on the support site for rekordbox.

rekordbox support site

<http://www.prodjnet.com/rekordbox/support/>

- To make an inquiry about rekordbox, you need to register as a user in advance on the support site for rekordbox.
- You need to enter the license key for your user registration. Have the license key ready. Also, be sure not to forget the login name (your e-mail address) and the password specified for your user registration, as well as the license key.
- Pioneer Corporation collects your personal information for the following purposes:
 - 1 To provide customer support for your purchased product
 - 2 To inform you of product or event information by e-mail
 - 3 To reflect your opinions collected by survey on product planning
 - Your personal information is kept confidential corresponding to the privacy policy set forth by our company.
 - You can check our privacy policy on the support site for rekordbox.
- When making inquiries regarding rekordbox, please be sure to furnish your computer type and specifications (CPU, installed memory, other connected peripherals, etc.), the operating system and version used, as well as concrete information regarding the issue at hand.
 - For an inquiry about configuring your computer with peripheral devices other than our products and the corresponding technical support, contact each manufacturer or retailer.
- rekordbox is subject to upgrade for enhanced function and performance. The upgrade program can be downloaded on the support site. We strongly recommend you upgrade your software on a regular basis to keep the latest updates on your system.

Specifications

Power requirements	AC 120 V, 60 Hz
Power consumption	21 W
Power consumption (standby)	0.4 W
Main unit weight	3.3 kg (7.3 lb)
Max. dimensions.....	305 mm (W) × 105.5 mm (H) × 364.4 mm (D) (12 in. (W) × 4.2 in. (H) × 14.3 in. (D))
Tolerable operating temperature	+5 °C to +35 °C (+41 °F to +95 °F)
Tolerable operating humidity	5 % to 85 % (no condensation)

Analog audio output (AUDIO OUT L/R)

Output terminal.....	RCA terminal
Output Level	2.0 Vrms (1 kHz)
Frequency response	4 Hz to 20 kHz
S/N ratio	≥115 dB
Total harmonic distortion	≤0.003 %

USB downstream section (USB)

Port	Type A
Power supply.....	5 V/500 mA or less

USB upstream section (USB)

Port	Type B
------------	--------

Control output (CONTROL)

Port	Mini-jack
------------	-----------

- The specifications and design of this product are subject to change without notice.
- The articles concerning free repairs, etc., indicated on the warranty do not apply to the rekordbox music management software. Before installing or using rekordbox, carefully read the articles in *Software end user license agreement* on page 9.



Pioneer Electronics(USA) Inc.

Limited Warranty

WARRANTY PERIOD

For the period specified below from the date of original purchase (the warranty period), Pioneer Electronics(USA) Inc. (Pioneer) warrants that the products described below, if purchased directly from Pioneer or from an authorized Pioneer dealer or distributor in the United States and installed and operated according to operating instructions enclosed with the unit, will be repaired or replaced with a unit of comparable value, at the option of Pioneer, without charge to you for parts or labor for actual repair work if such products fail to function properly under normal use due to a manufacturing defect. Parts supplied under this warranty may be new or rebuilt at the option of Pioneer.

PRODUCTS COVERED	MODEL PREFIX	WARRANTY PERIOD	
		Parts	Labor
DJ Compact Disc Player	CDJ, CMX	1 YEAR	1 YEAR
DJ DVD Player	DVJ	1 YEAR	1 YEAR
Digital Media Player	DMP	1 YEAR	1 YEAR
DJ Mixer	DJM	1 YEAR	1 YEAR
DJ Effector	EFX	1 YEAR	1 YEAR
Video Switcher	VSW	1 YEAR	1 YEAR

This warranty covers the product during the warranty period whether in the possession of the original owner or any subsequent owner.

WHAT'S NOT COVERED

This warranty does not cover the A-B Cross Fader in the DJ Mixer (model prefix DJM). This warranty does not cover any appearance item, any damage to the product resulting from alterations, modifications not authorized in writing by Pioneer, accident, misuse or abuse, damage due to lightning or to power surges or personal injury due to excessive sound pressure levels. This warranty does not cover the cost of parts or labor which would be otherwise provided without charge under this warranty, obtained from any source other than a Pioneer Authorized Service Company or other designated location. This warranty does not cover defects or damage caused by the use of unauthorized parts or labor, or from improper maintenance.

PRODUCTS WITH ALTERED, DEFACED OR REMOVED SERIAL NUMBERS SHALL VOID THIS WARRANTY.

YOUR RIGHTS

SOME STATES DO NOT ALLOW THE EXCLUSION OR LIMITATION OF INCIDENTAL OR CONSEQUENTIAL DAMAGES, SO THE FOLLOWING LIMITATIONS OR EXCLUSIONS MAY NOT APPLY TO YOU.

THE ABOVE WARRANTIES ARE IN LIEU OF AND EXCLUDE ALL OTHER WARRANTIES, EXPRESSED OR IMPLIED, INCLUDING WITHOUT LIMITATION IMPLIED WARRANTIES OF MERCHANTABILITY AND FITNESS FOR ANY PARTICULAR PURPOSE. IN NO EVENT SHALL PIONEER BE LIABLE FOR INCIDENTAL OR CONSEQUENTIAL DAMAGES ARISING OUT OF LOSS OF USE OR CLAIMS ASSERTED ON THE BASIS OF TORT (INCLUDING NEGLIGENCE), CONTRACT, OR OTHERWISE.

TO OBTAIN SERVICE

Pioneer has appointed a number of Authorized Industrial Service Companies throughout the U.S.A. should your product ever require service. To receive warranty service you will need to present your sales receipt or, if rented, your rental contract showing place and date of original purchase transaction.

Should it become necessary to ship the unit, you will need to package the product and send it, transportation prepaid, to an Authorized Service Company in the U.S.A. Carefully package the product using adequate padding material to prevent damage in transit. The original container is ideal for this purpose. Include in the package your name, address, telephone number where you can be reached during business hours, a copy of your sales receipt, and a detailed description of the problem.

To find the name and address of the nearest Pioneer Authorized service location, to obtain warranty service or for additional information about this warranty, please call or write:

PIONEER ELECTRONICS(USA) INC.
CUSTOMER SUPPORT DIVISION
P.O. BOX 1760
LONG BEACH, CALIFORNIA 90801-1760
1-800-872-4159

DO NOT RETURN ANY PRODUCT TO ABOVE ADDRESS. IT IS NOT A SERVICE LOCATION.

TO ORDER REPLACEMENT PARTS CALL 800-228-7221

RECORD THE PLACE AND DATE OF PURCHASE FOR FUTURE REFERENCE

Model No. _____ Serial No. _____ Purchase Date _____

Purchased From _____

KEEP THIS INFORMATION AND YOUR SALES RECEIPT IN A SAFE PLACE

To register your product, find the nearest authorized service location, to purchase replacement parts, operating instructions, or accessories, please go to one of following URLs :

Pour enregistrer votre produit, trouver le service après-vente agréé le plus proche et pour acheter des pièces de rechange, des modes d'emploi ou des accessoires, reportez-vous aux URL suivantes :

In the USA/Aux Etats-Unis

<http://www.pioneerelectronics.com>

In Canada/Aux Canada

<http://www.pioneerelectronics.ca>

S018_B1_EnFr

Published by Pioneer Corporation.
Copyright © 2010 Pioneer Corporation.
All rights reserved.

PIONEER CORPORATION

1-1, Shin-ogura, Saiwai-ku, Kawasaki-shi, Kanagawa 212-0031, Japan

PIONEER ELECTRONICS (USA) INC.

P.O. BOX 1540, Long Beach, California 90801-1540, U.S.A. TEL: (800) 421-1404

PIONEER ELECTRONICS OF CANADA, INC.

300 Allstate Parkway, Markham, Ontario L3R 0P2, Canada TEL: 1-877-283-5901, 905-479-4411

PIONEER EUROPE NV

Haven 1087, Keetberglaan 1, B-9120 Melsele, Belgium TEL: 03/570.05.11

PIONEER ELECTRONICS ASIACENTRE PTE. LTD.

253 Alexandra Road, #04-01, Singapore 159936 TEL: 65-6472-7555

PIONEER ELECTRONICS AUSTRALIA PTY. LTD.

178-184 Boundary Road, Braeside, Victoria 3195, Australia, TEL: (03) 9586-6300

PIONEER ELECTRONICS DE MEXICO S.A. DE C.V.

Blvd.Manuel Avila Camacho 138 10 piso Col.Lomas de Chapultepec, Mexico, D.F. 11000 TEL: 55-9178-4270

K002_B1_En

Printed in

<DRB1526-A>

